

# DeviceNet™ Configuration Terminal

Catalog Numbers 193-DNCT

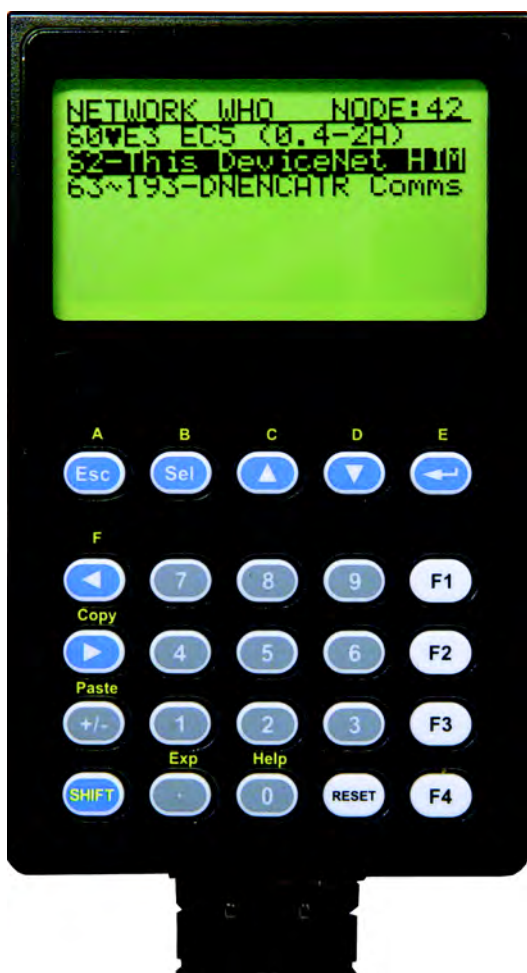



---

## Important User Information

Because of the variety of uses for the products described in this publication, those responsible for the application and use of this control equipment must satisfy themselves that all necessary steps have been taken to assure that each application and use meets all performance and safety requirements, including any applicable laws, regulations, codes and standards.

The illustrations, charts, sample programs and layout examples shown in this guide are intended solely for purposes of example. Since there are many variables and requirements associated with any particular installation, Rockwell Automation does not assume responsibility or liability (to include intellectual property liability) for actual use based upon the examples shown in this publication.

Allen-Bradley publication SGI-1.1, Safety Guidelines for the Application, Installation and Maintenance of Solid-State Control (available from your local Allen-Bradley distributor), describes some important differences between solid-state equipment and electromechanical devices that should be taken into consideration when applying products such as those described in this publication.

Reproduction of the contents of this copyrighted publication, in whole or part, without written permission of Rockwell Automation, is prohibited.

Throughout this manual we use notes to make you aware of safety considerations:



**ATTENTION:** Identifies information about practices or circumstances that can lead to personal injury or death, property damage or economic loss

---

Attention statements help you to:

- identify a hazard
- avoid a hazard
- recognize the consequences

---

**IMPORTANT** Identifies information that is critical for successful application and understanding of the product.

---

## European Communities (EC) Directive Compliance

If this product has the CE mark, it is approved for installation within the European Union and EEA regions. It has been designed and tested to meet the following directives.

- EMC Directive
- This product is tested per EN61000-6-4:2001 and EN61000-6-2:2005.

Allen-Bradley is a trademark of Rockwell Automation. DeviceNet™ is a trademark of the Open DeviceNet™ Vendors Association (ODVA). All other trademarks and/or registered trademarks are the property of their respective owners.

---

## Manual Objectives

The purpose of this manual is to provide you with the information necessary to apply the DeviceNet™ Configuration Terminal. Described in this manual are methods for installing, configuring, and troubleshooting the DeviceNet™ Configuration Terminal.

---

**IMPORTANT** Read this manual in its entirety before installing, operating, servicing, or initializing the DeviceNet™ Configuration Terminal.

---

## Who Should Use This Manual

This manual is intended for qualified personnel responsible for setting up and servicing DeviceNet™ devices. You must have previous experience with and a basic understanding of communications terminology, configuration procedures, required equipment, and safety precautions.

You should understand DeviceNet™ network operations, including how devices operate on the network.

## Vocabulary

In this manual we refer to the:

Bulletin 193 DeviceNet™ Configuration Terminal as 193-DNCT, DNCT, terminal, Configuration Terminal, or HIM (Human Interface Module)

Programmable Logic Controller as a Programmable Controller, PLC controller, SLC controller, ControlLogix Controller, or PLC

DeviceNet™ as DNet or DNET

## Reference Manuals

DeviceNet™ Media Design and Installation Guide

- Publication DNET-UM072\_-EN-P

---

**IMPORTANT** Read the DeviceNet™ Media Design and Installation Guide (Publication DNET-UM072\_-EN-P) in its entirety before planning and installing a DeviceNet™ system. If the network is not installed according to this document, unexpected operation and intermittent failures may occur.

---

Copies of this and all other reference publications are available at <http://www.rockwellautomation.com/literature/>.

	Important User Information . . . . .	iii
	European Communities (EC) Directive Compliance. . . . .	iii
	Manual Objectives . . . . .	iv
	Who Should Use This Manual . . . . .	iv
	Vocabulary . . . . .	iv
	Reference Manuals . . . . .	iv
	<b>Chapter 1</b>	
<b>Product Overview</b>	Product Overview. . . . .	5
	Bill of Material. . . . .	5
	Accessories . . . . .	5
	<b>Chapter 2</b>	
<b>Installation and Wiring</b>	Installation and Wiring. . . . .	7
	193-CB1 Physical Connections. . . . .	7
	193-CM1 Physical Connections. . . . .	7
	193-DNCT-BZ1 Physical Connections. . . . .	8
	Powering the 193-DNCT . . . . .	8
	<b>Chapter 3</b>	
<b>Physical Features</b>	Physical Features . . . . .	9
	Communication Port . . . . .	9
	Key Descriptions. . . . .	10
	Shifted Key Descriptions . . . . .	10
	<b>Chapter 4</b>	
<b>Quick Start</b>	Powerup . . . . .	11
	Terminal Setup . . . . .	12
	Network Who Screen . . . . .	12
	Device Choices Menu . . . . .	12
	Parameter Monitoring and Editing . . . . .	13
	DeviceNet™ Configuration Terminal Setup Menus. . . . .	15
	Port Object And Routing Sub Nets. . . . .	15
	Who Menu Display . . . . .	16
	<b>Chapter 5</b>	
<b>Device Choices Menu</b>	Device Choices Menu . . . . .	17
	Version Menu . . . . .	17
	Standard Device Status Menu . . . . .	18
	Fault/Warning Choice Menu . . . . .	18
	Fault Menu . . . . .	18
	Warning Menu . . . . .	19

	<b>Chapter 6</b>	
<b>Parameter Choices Menu</b>	Parameter Choices Menu .....	21
	Groups Screen .....	21
	Num List Selection .....	21
	Parameter Edit Screens.....	22
	Numeric Parameters.....	22
	Accessing a Different Parameter .....	22
	Changing a Parameter Value .....	23
	Enumerated Parameters.....	25
	Floating Point Parameters.....	26
	Search for Changed Parameters.....	27
	Parameter Display-Value Enumerated.....	28
	<b>Chapter 7</b>	
<b>Copy Cat Menu</b>	Copy Cat.....	29
	Copy Cat Uploading .....	29
	Copy Cat Downloading.....	31
	Copy Cat Downloading and Product Revisions .....	33
	Copy Cat Downloading and Product Current Ratings.....	34
	Deleting Copy Cat Files.....	36
	Copy Cat Memory .....	36
	DeviceLogix™ Library 5 Support .....	36
	<b>Chapter 8</b>	
<b>Tools Menu</b>	Tools Menu.....	37
	Node Commissioning .....	37
	Class Instance Attribute Editor.....	37
	Graph Setup Screens.....	38
	Graph View Screen .....	40
	Assembly Consumed/Produced Menu .....	40
	<b>Chapter 9</b>	
<b>Advanced Functions Menu</b>	Advanced Functions Menu.....	43
	<b>Chapter 10</b>	
	HeartBeat Menus .....	45
	<b>Chapter 11</b>	
<b>I/O Message Monitoring</b>	I/O Message Monitoring.....	47

	<b>Chapter 12</b>	
<b>DeviceLogix™ Functionality</b>	DeviceLogix™ Functionality .....	49
	DeviceLogix™ Choices Menu .....	49
	DeviceLogix™ Monitor .....	49
	Boolean Gates: .....	50
	Bistable Latches: RS Latch and SR Latch .....	50
	Counters: Up Counter and Up/Down Counter .....	50
	Timers: On Delay, Off Delay and Pulse Timer .....	51
	Discrete Output Points (DOPs): .....	51
	Produced Network Bits (PNBs): .....	51
	DeviceLogix™ Editor .....	51
	Creating a New Function Block .....	52
	Function Blocks .....	53
	Assigning Source Bits to Function Block Inputs .....	53
	<b>Chapter 13</b>	
<b>Discrete I/O Status</b>	Discrete I/O Status .....	55
	<b>Chapter 14</b>	
<b>Zone Interlock Protocol (ZIP)</b>	Zone Interlock Protocol (ZIP) .....	57
	ZIP Consumed .....	57
	Mapping Consumed ZIP Data .....	58
	ZIP Produced Data .....	61
	ZIP Data Table Monitor .....	61
	<b>Chapter 15</b>	
<b>DeviceNet™ Scanner Menu</b>	DeviceNet™ Scanner Menu .....	63
	Scanner Setup .....	63
	AutoScan Function .....	64
	ScanList Screen .....	64
	Node Activation Screen .....	64
	<b>Chapter 16</b>	
<b>Terminal Choices Menu</b>	Terminal Choices Menu .....	65
	Version Menu .....	65
	Offline Connection Set .....	65
	Offline Change Address Screen .....	66
	DeviceNet™ Error Log .....	67
	Network Statistics Screen .....	67

	<b>Chapter 17</b>	
<b>Terminal Setup Menu</b>	Terminal Setup Menu .....	69
	Communication Setup Screen (HIM Comm) .....	69
	Password Menu .....	70
	Password Setup (Primary) .....	71
	Password Setup (Secondary) .....	71
	Entering a Password .....	72
	Resetting Forgotten Passwords .....	72
	Auto Display .....	72
	AutoDisplay Setup .....	73
	AutoDisplay Test .....	73
	Programmable User Function Key Setup .....	74
	Function Key Setup Screen .....	75
	LCD Contrast .....	75
	<b>Chapter 18</b>	
<b>Copy and Paste Feature</b>	Copy and Paste Feature .....	77
	<b>Chapter 19</b>	
<b>Menu Help Feature</b>	Menu Help Feature .....	79
	<b>Chapter 20</b>	
<b>Specifications</b>	Specifications .....	81
	<b>Appendix A</b>	
<b>DeviceNet™ Objects</b>	Identity Object .....	83
	Message Router .....	84
	DeviceNet™ Object .....	84
	Connection Object .....	85



## Product Overview

### Product Overview

The 193-DNCT product is a handheld device that can be used to commission, configure, program, and monitor other devices on a DeviceNet™ network. In addition, the 193-DNCT can be used to upload, store, and later download complete device configurations for DeviceNet™ devices via the network. The 193-DNCT also has the capability to present DeviceNet™ physical layer diagnostics and network bandwidth statistics to the user.

### Bill of Material

The 193-DNCT product package includes the following items:

Item	Description	Quantity
193-DNCT	DeviceNet™ Configuration Terminal	1
193-CB1	1 m DNCT Cable with color-coded bare leads	1
193-QR002_-EN-P	DeviceNet™ Configuration Terminal Quick Reference	1

### Accessories

Description	Catalog No.
1 m DNCT Cable with color-coded bare lead	193-CB1
1 m DNCT Cable with microconnector (male)	193-CM1
Door mount bezel kit	193-DNCT-BZ1
Mini-Mini-Micro Tee for connection to ArmorStart	1485P-P1R5-MN5R1
5-pin connector	1787-PLUG10R



**ATTENTION:** The Bulletin 193 DeviceNet™ Configuration Terminal should only be used on a DeviceNet™ network.

**Notes:**

## Installation and Wiring

### Installation and Wiring

The DNCT ships complete with a 1 m cable (193-CB1) for connection to a DeviceNet™ network. This cable has a plug connection to the terminal on one end, and color coded bare leads on the other end. Alternately, a 1 m cable (193-CM1) can be ordered that has a plug connection to the terminal on one end, and a DeviceNet™ male micro style connector on the other end. A bezel mounting kit (193-DNCT-BZ1) is available for mounting the terminal to a panel door.

### 193-CB1 Physical Connections

The 193-CB1 cable that ships with the Configuration Terminal has a plug connection to the terminal on one end, and color coded bare leads on the other end. The cable's bare leads are wired to a DeviceNet™ connector according to the following table:

Signal	Function	Color
V-	Common	Black
Can_L	Signal Low	Blue
Drain	Shield	Non-insulated
Can_H	Signal High	White
V+	Power Supply	Red

### 193-CM1 Physical Connections

The optional Cat. No.193-CM1 has a plug connection to the terminal on one end and a DeviceNet™ male micro-style connector on the other end. The cable's micro connector pin-out is shown in Figure 1 -

Figure 1 - Cat. No. 193-CM1 Pinout

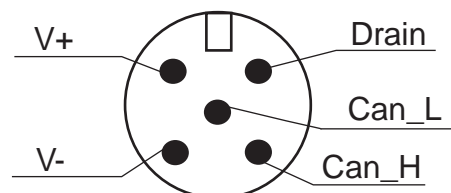

## 193-DNCT-BZ1 Physical Connections



**ATTENTION:** When mounting in a door or panel-mounted bezel kit, only the Cat. No. 193-DNCT-BZ1 DeviceNet™ Bezel Kit should be used with the Bulletin 193-DNCT DeviceNet™ Configuration Terminal.

The optional Cat. No. 193-DNCT-BZ1 connects to the DeviceNet™ network via an attached cable that has color coded bare leads. The cable's bare leads are wired to a DeviceNet™ connector according to the following table:

Signal	Function	Color
V-	Common	Black
Can_L	Signal Low	Blue
Drain	Shield	Non-insulated
Can_H	Signal High	White
V+	Power Supply	Red

### Powering the 193-DNCT

The DNCT must be powered from an external 24V DC source through the communication cable. The 24V DC connections should be made to the V+ and V- pins/wires in the above cable pinout/wire definitions.



**ATTENTION:** Before physically connecting the DNCT to a target device, verify that the external power supply has adequate capacity to power all devices on the network.

## Physical Features

### Physical Features



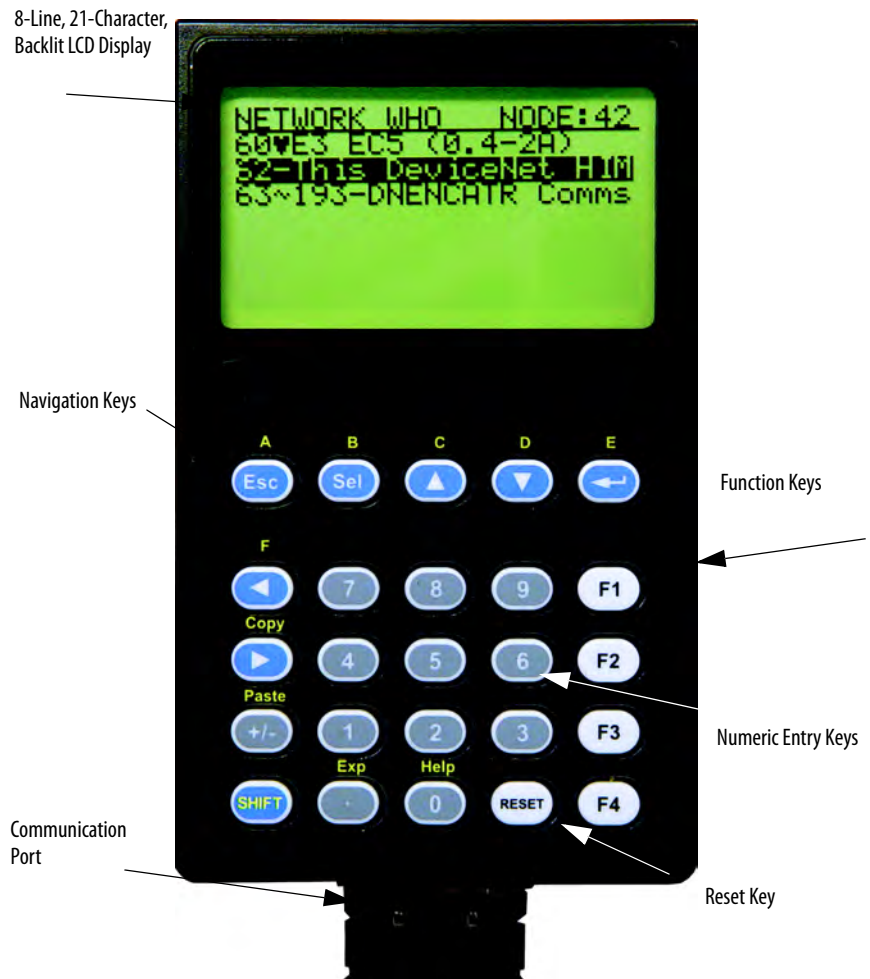









Figure 1 - Cat. No. 193-DNCT Physical Features



### Communication Port









The communication port is used to connect the DNCT to a DeviceNet™ network through use of a communication cable or bezel mount kit (Cat. No. 193-DNCT-BZ1). Additionally, 24V DC power is provided to the DNCT at the communication port.

## Key Descriptions

	Escape Key. Exit a menu or cancel a change.
	Select key. Select a value, digit, or screen choice.
	Increment key. Scroll through options, increase a value, or toggle a bit.
	Decrement key. Scroll through options, decrease a value, or toggle a bit.
	Enter key. Enter a menu, enter a mode, or enter a value.
	Scroll left or right keys. Scroll left or right through a value.
	Shift key. Small values (yellow text) on top of keys are entered when pressed after the shift key.
	Used to enter numbers.
	Used to enter a decimal place for a number.
	Used to negate a numeric value. Used to add a sign character when editing a value.
	Programmable function keys. See Chapter 16, Function Key Setup Screen.
	Programmable Reset key. See Chapter 16, Function Key Setup Screen.

## Shifted Key Descriptions

The following table describes the alternate functionality of each key when it is pressed after the shift key.

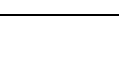
Key Combination	
	The letter A. Used to enter values in hexadecimal.
	The letter B. Used to enter values in hexadecimal.
	The letter C. Used to enter values in hexadecimal.
	The letter D. Used to enter values in hexadecimal.
	The letter E. Used to enter values in hexadecimal.
	The letter F. Used to enter values in hexadecimal.
	Copy function. Used to copy Class, Instance, and/or Attribute data to the clipboard. Available on screens displaying a small "C" in the upper right corner.
	Exponential function. Used to enter values in exponential notation.
	Paste function. Used to paste Class, Instance, and/or Attribute data from the clipboard. Available on screens displaying a small "P" in the upper right corner.
	Help function. Invoke help information for the current screen.

## Quick Start

### Powerup

The DeviceNet™ Configuration Terminal is shipped so that when it is placed on the network for the first time, it will automatically set its baud rate to that of the traffic on the network, and then assign itself an unused network address. On power up, the following screen is displayed:



Note that there is a 10-second powerup delay programmed at the factory. The above screen will appear for at least 10 seconds on initial powerup. The powerup delay can be modified in the Terminal Setup screen described in the following section. Once the baud rate is determined and a network address has been set, the terminal will display the Network Who screen, which displays a list of all devices on the network.

#### IMPORTANT

If the terminal fails to enter the Network Who screen after approximately 20 seconds, it is because it could not determine the network baud rate due to lack of traffic on the network. Pressing the **ESC** key will allow the user to enter the Terminal Setup screen so that a fixed baud rate and network address can be set for the terminal.

**Note:** To go directly to the Terminal Setup screen, press and hold the **ESC** key during powerup.

## Terminal Setup

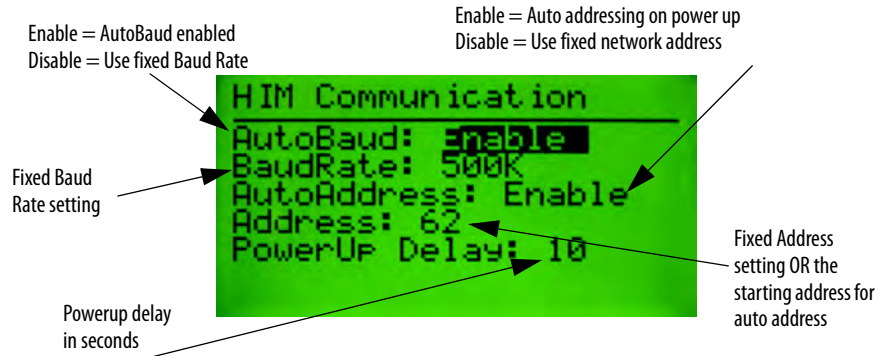

To scroll through the items on the screen, press the **SEL** key. To change the value of a selected item, press the **Increment** or **Decrement** key. To commit the new value for use, press the **Enter** (return arrow) key. To exit this screen, press the **ESC** key.

## Network Who Screen

The terminal searches for all devices on the network and reports the devices it has found on the Network Who screen. Use the **Increment** or **Decrement** key to scroll through devices. Press **Enter** (return arrow) to invoke the Device Choices menu.

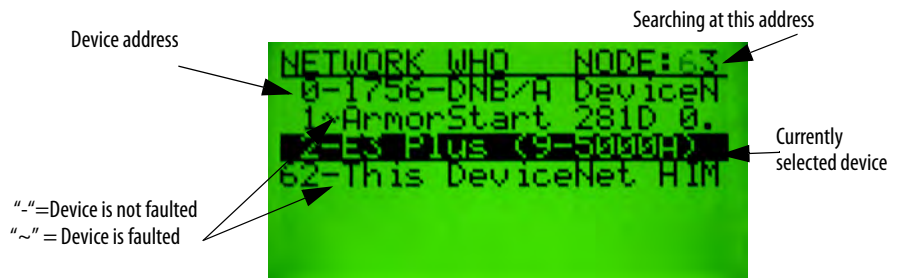

## Device Choices Menu

This menu allows the user to choose what operation is to be performed for the selected device. The terminal only displays choices that are appropriate for the selected device. The **Increment** and **Decrement** keys allow the operator to scroll through the selections. The **Enter** key will advance to the selected operation.

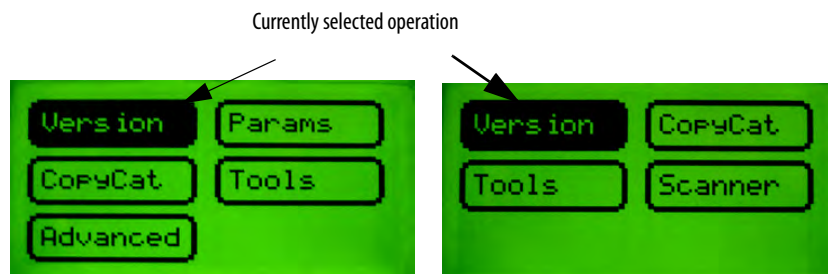



**Version:** Displays Version information for the selected device.

**Params:** Provides access to configuration and status parameters for the selected device. Allows the operator to search for parameters that are not at factory defaults.

**Copy Cat:** Upload and store complete device configurations, including DeviceLogix™ programs to the programming terminal's memory. Download stored device configurations from the programming terminal memory to the selected device.

**Tools:** Provides access to Node Commissioning functions, the Class Instance Attribute editor, and the real time graphing function.

**Advanced:** Provides access to the DeviceLogix™ editor, DeviceNet™ IO message timing information, ZIP configuration, and local input and output status display.

**Scanner:** If the selected device is a DeviceNet™ scanner, provides access to simple scanner configuration values and access to the scan list.

## Parameter Monitoring and Editing

Parameters can be accessed as either groups or as a numbered list of all parameters. The Parameter Screen displays all information for a single parameter. From the Parameter Screen, parameter values can be monitored or edited. Scrolling through a parameter list is accomplished by pressing the **Increment** or **Decrement** keys from the Parameter Screen. Parameters can also be accessed by entering a parameter number with the **numeric** keys while in the Parameter Screen. The parameter screen has the following format:

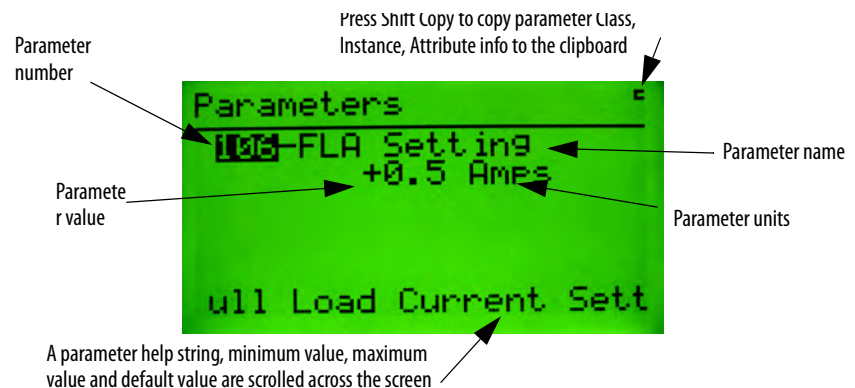

Parameter values are continuously updated.

Change a parameter value by first pressing the **SEL** key and then modifying the selected value.

1) Press the **SEL** key to select the value

2) The Increment and Decrement keys increment or decrement the value when it is selected. An edit box will appear when a key is pressed.  
OR  
Enter a number from the numeric keypad. An edit box will appear when a key is pressed.

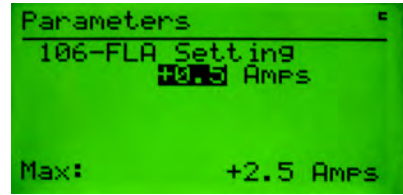

Pressing the **Enter** key will write the new value to the selected device. When a parameter value is selected, pressing the **ESC** key will deselect the parameter value and allow movement within the parameter list or group.

Bit-enumerated parameters are displayed and modified as follows:

1) Press the **SEL** key to select a bit to change. The selected bit name is displayed here

Press < (scroll left) or > (scroll right) to select the next bit

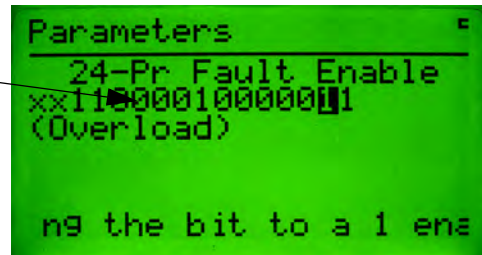

2) Press the **Increment** (or 0) or **Decrement** (or 1) key or to toggle the bit value

Pressing the **Enter** key will write the new value to the selected device. When a parameter value is selected, pressing the **ESC** key will deselect the parameter value and allow movement within the parameter list or group. Pressing the **ESC** key will delete changes and revert to the previous settings for that parameter.

## DeviceNet™ Configuration Terminal Setup Menus

The 193 DeviceNet™ Configuration Terminal often refers to itself as a HIM (Human Interface Module). When **This DNet HIM** is chosen from the Network Who screen, the following HIM Choices Menu appears:

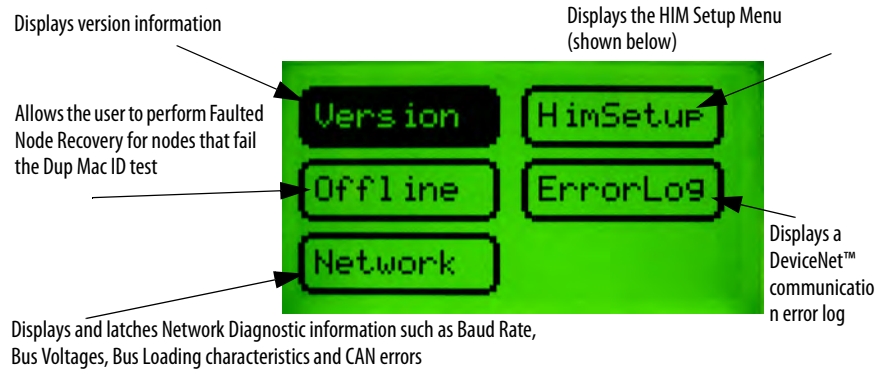

The HIM Setup menu allows the user to configure many of the programming terminal features.

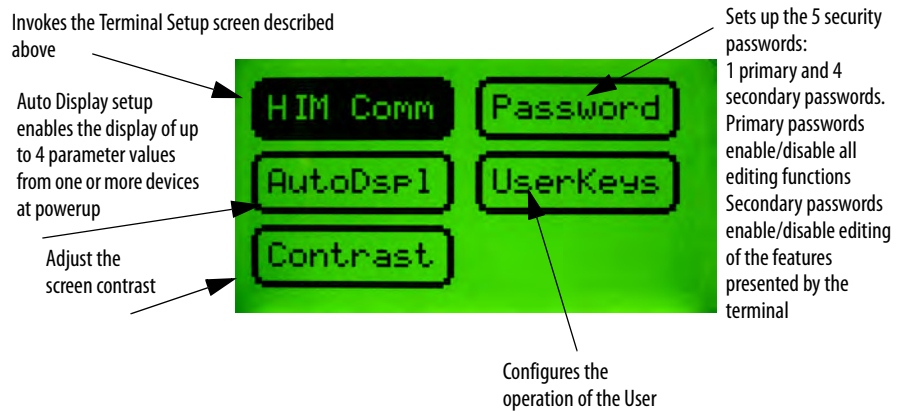

## Port Object And Routing Sub Nets

The 193-DNCT has the capability to route down one DeviceNet™ sub net for devices that support the Port Object. This allows the user to easily view devices on the network display menu.

## Who Menu Display

The Who Menu displays the device information for devices that support a DeviceNet™ sub net.

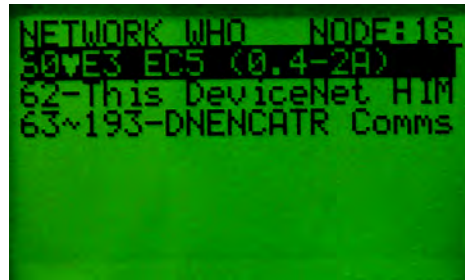

When the +**DeviceNet Subnet** choice is selected and the **Enter** key is pressed, the **Subnet Who Menu** will be displayed.

Selecting a device at the **Subnet Who** menu and pressing the **Enter** key will display all of the menus available at the standard **Who** menu.

## Device Choices Menu

### Device Choices Menu

The Device Choices menu is entered from the Network Who screen when a device is selected and the **Enter** key is pressed. This menu allows the operator to choose what operation is to be performed on the selected device. The choices on this menu are only displayed for features that the selected device supports. The **Inc** and **Dec** keys allow the operator to move up and down through the selections. The **Enter** key will advance to the selected menu.

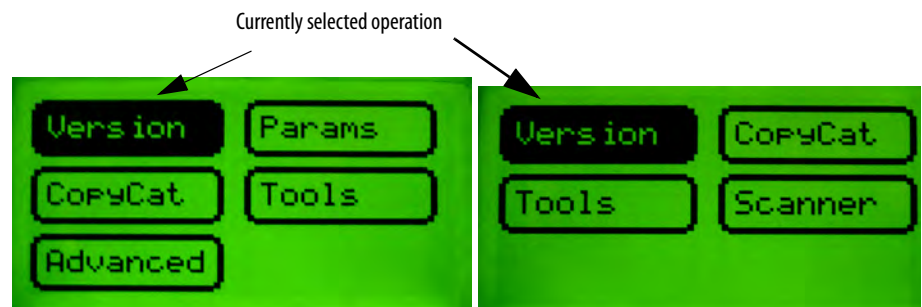

If the currently selected device is the DeviceNet™ HIM, this menu will be slightly different. See Chapter 15, DeviceNet™ Terminal Choices, for description. Not all choices will be available for all devices.

### Version Menu

The Version Screen appears when **Version** is selected from the Device Choices Menu. It displays the major revision, minor revision, and if supported the build number of the selected device. If multiple instances of the Identity Object are supported in the selected device, the revision number for each instance is displayed. Use the **Inc/Dec** keys to select the different instances of the Identity Objects. The **Esc** key will return the user to the Device Choices menu.

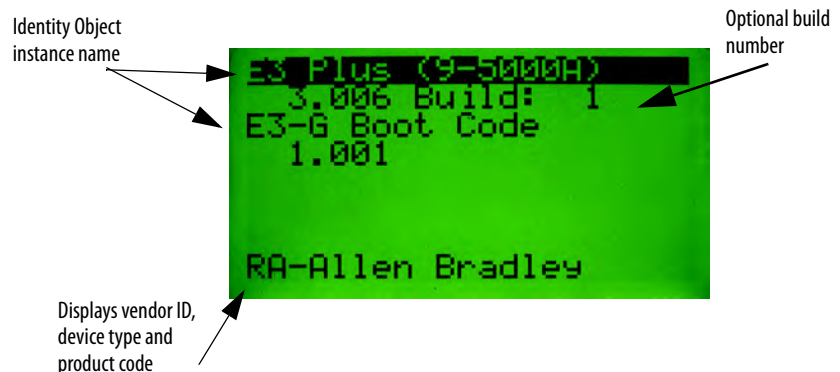

## Standard Device Status Menu

The 193-DNCT displays the following menu for devices that do not support the Fault or Warning Object. The Identity Object Status Attribute (5) is monitored continuously when viewing this menu. The display is updated to reflect the status of the device.

Status of the Fault  
 0= Fault is not active  
 1= Fault is active

Note: Help String is displayed only if the fault is active

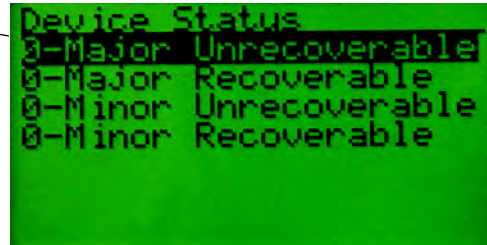

Status of the four fault states in the device

## Fault/Warning Choice Menu

The following menu appears after the **Fault** button is pressed on the **Device Choices** menu if the current device supports both the Fault Object and the Warning Object.

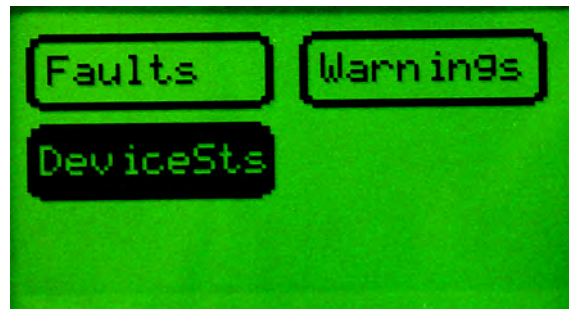

## Fault Menu

The fault menu displays a buffer of fault information. From the Fault Object, the 193-DNCT is able to read the size of the fault buffer, the trip fault, the fault codes and the fault name strings. Other optional information may also be available such as a fault timestamp and a help string explaining the fault. The menu has a **Clear Buffer** command that will clear all of the entries in the buffer, however, it will not clear any active faults. The reset button on the 193-DNCT keypad can be used to attempt to clear the current active fault and it will sent a clear fault command to the device's Fault Object.

NOTE: The 193-DNCT has a limited buffer size of 25 faults

**Figure 1 - Fault Buffer with all optional attributes supported with a fault present.**

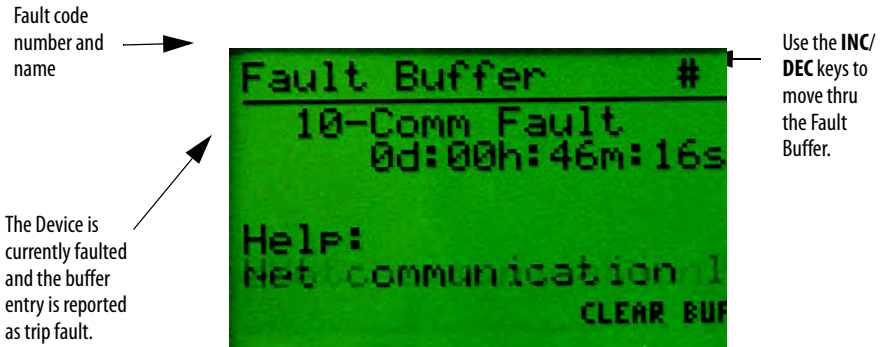

**Figure 2 - Fault Buffer with all optional attributes supported**

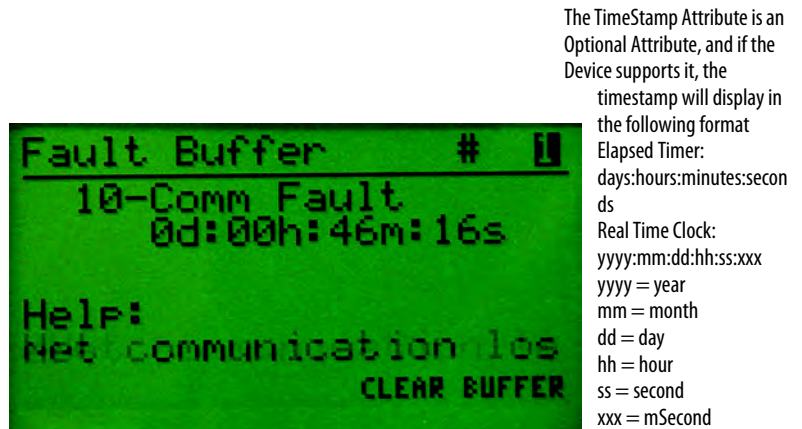

## Warning Menu

The Warning Menu is designed to display a buffer of warning information. Based on the Warning Object, the 193-DNCT can read the size of the warning buffer, the warning codes and the warning name strings. Other optional information, such as a timestamp and a help string about the warning, are also available. The menu has a **Clear Buffer** command which will clear all of the entries in the buffer, but it will not clear any current warnings. The Reset button on the 193-DNCT

keypad can be used to attempt to clear the current warning by sending a clear warning command to the devices Warning Object.

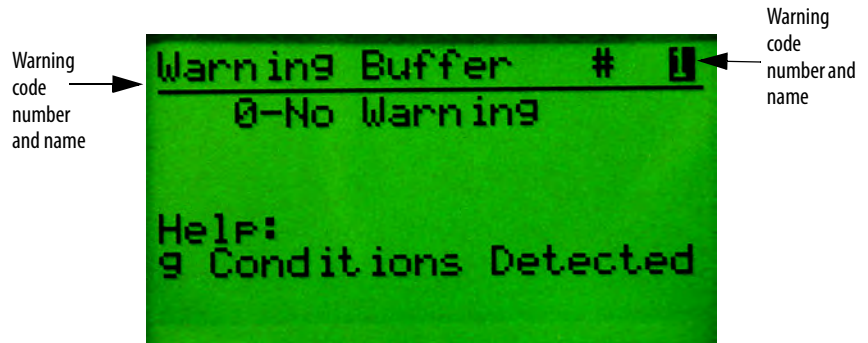
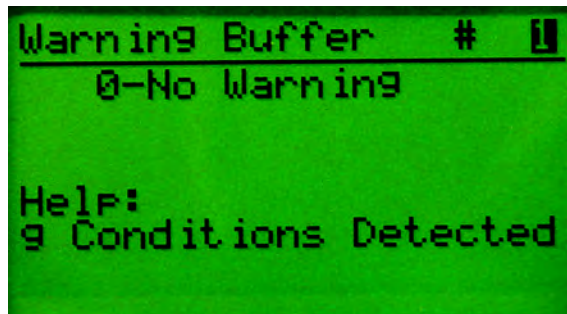

Figure 3 - Warning Buffer without optional attributes supported



Use the **SEL** key to move back and forth from the Buffer number to the **Clear Buffer** Command. With the **Clear Buffer** choice highlighted, press the **Enter** key to clear the buffer.



## Parameter Choices Menu

### Parameter Choices Menu

The Parameter Choices Menu is only available if the selected device has built-in parameter support (DeviceNet™ Parameter Object). This menu allows the operator to go to screens that monitor and change parameters, view/select parameter groups, and search for parameters that are not at their default settings. The **Inc** and **Dec** keys allow the operator to move up and down through the selections. The **Enter** key advances the user to the selected item. The **Esc** key returns the user to the Device Choices Menu.

Currently selected function

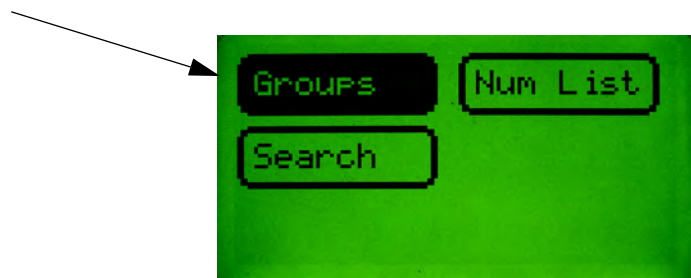

### Groups Screen

This screen allows the operator to select a group of parameters to be monitored/edited. The **Inc** and **Dec** keys allow the operator to move up and down through the selections. The **Enter** key advances the operator to a Parameter Edit Screen. The **Esc** key will return the user to the Parameter Choices Menu. The choices in this menu are only displayed for groups that the selected device supports.

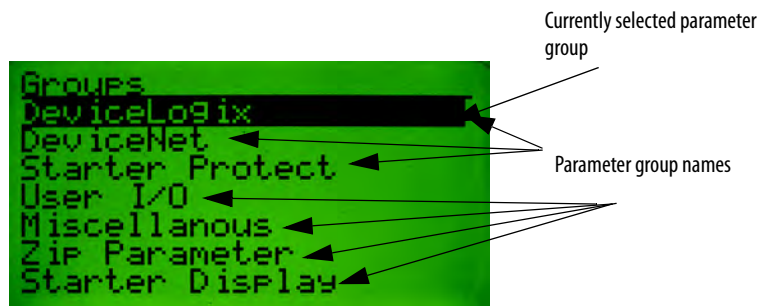

### Num List Selection

A numerical list (Num List) of Parameter Edit Screens are presented when Num List is selected and the **Enter** key is pressed.

## Parameter Edit Screens

The Parameter Edit Screens allow the device's parameters to be monitored and edited. The parameter screens have slightly different formats for each parameter data type (numeric, value enumerated, bit enumerated Boolean, etc.)

## Numeric Parameters

Numeric parameter values are displayed as follows:

The diagram shows two examples of how numeric parameters are displayed on a green screen. The first example shows 'Phase A Current' with a value of '+0.2 AMPS'. The second example shows 'Phase A Current' with a value of '+3276.7 AMPS' and additional information: 'Read Only', 'Max:', and 'Def:'. Arrows point from text labels to specific elements in the screenshots.

Parameter number

Parameter name

Parameter units

Parameter value

Indicates that this parameter is Read Only and its value cannot be edited.

If the Parameter has a Help string, the string will be scrolled across the bottom line. After the Help String is displayed, the Min value will be display for 3 seconds, followed by the Max value, and then the Default value. After the Default is displayed the string will repeat.

OR

This c indicates that the Class, Instance, and Attribute data for this parameter can be copied to the clipboard by pressing **Shift** key then the **Copy** Key.

Numeric Parameter values have this format

Note: If the parameter is a monitor parameter, the HIM stores the HI and LO values for the parameter during monitoring. The HI:/LO: values are displayed on the same line as the Min, Max, Def and Help string.

## Accessing a Different Parameter

Accessing a different parameter from a Parameter Edit Screen is done by entering or changing a new parameter number. Changing the parameter number can be done using the **Inc** or **Dec** key to increment through the currently active group of

parameters. Entering a new parameter number directly can be done by entering a number with the **numeric** keypad (only if accessed through the Num List).

Current parameter number

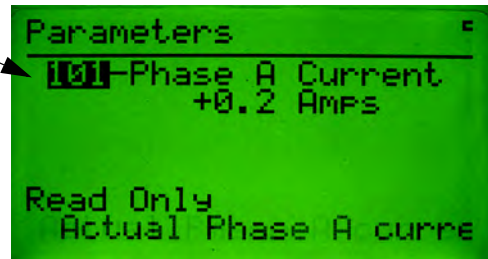

Pressing a numeric key will displayed an edit box to enter a new parameter number in.

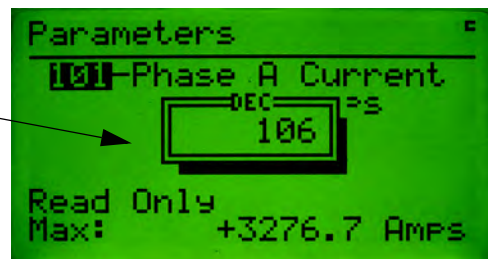

## Changing a Parameter Value

Changing a parameter value is done by pressing the **Sel** key to highlight the parameter value then using the **Inc/Dec** keys or **numeric** keys to enter the value. Pressing the **Enter** key will write the new value to the parameter. When the

parameter value is selected, pressing the **Esc** key will deselect the parameter value and allow the parameter number to be changed.

Press **Sel** key to select the Parameter Value



Pressing a numeric key will display an edit box to enter a new parameter value

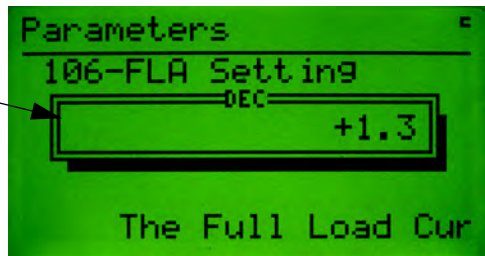

## Enumerated Parameters

Parameters that display **Value Enumerated** data values appear as follows:

Enumerated Parameter value

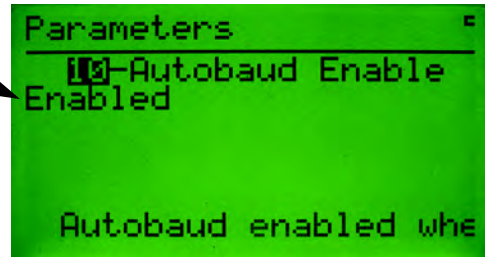

To change a value, press the **Sel** key to select the Enumerated Parameter value, then use the **Inc/Dec** key to change the value

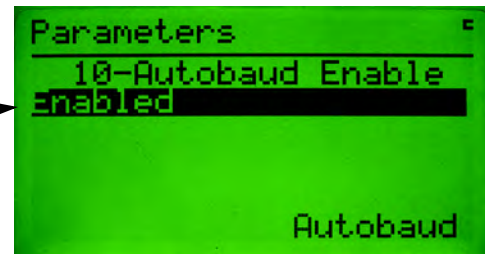

Parameters with **Bit Enumerated** data values are displayed as follows:

Bit enumerated parameter value

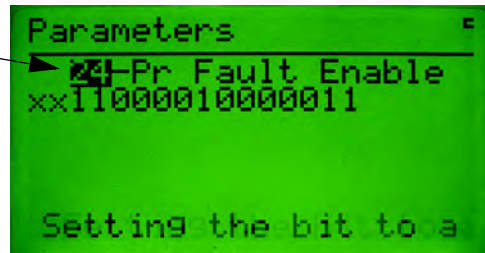

Bit selected

Text string associated with the selected bit

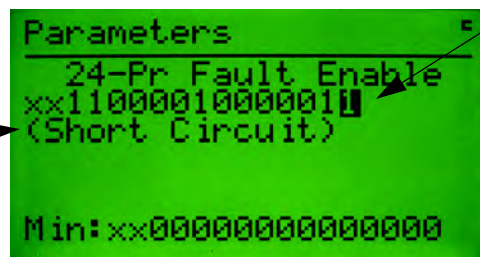

Press the **left/right** arrow key to select the next bit

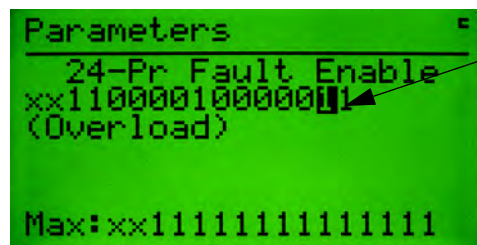

## Floating Point Parameters

Parameters with Floating Point values will be displayed as follows:

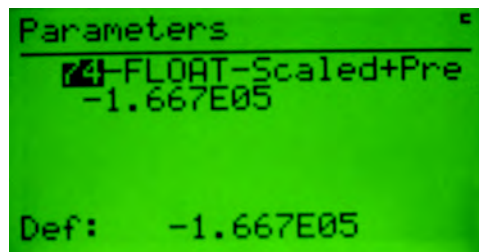

Entering floating point numbers is performed much the same as regular numeric parameters described earlier. The exponential (displayed as an “E”) is entered as follows:

Use the **Shift** key then the **Exp** key to add the **E** into the value when editing a floating point value

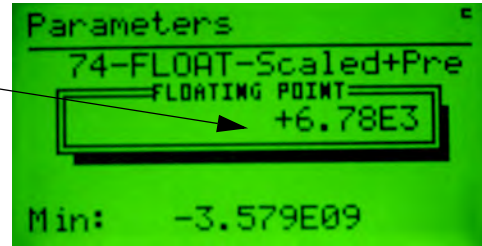

## Search for Changed Parameters

This function is invoked by selecting the Search option from the Parameter Choices Menu. The function searches through the selected device’s parameters and finds the parameters that are not at their default setting. The following screen is displayed when searching the parameter list for the selected device:

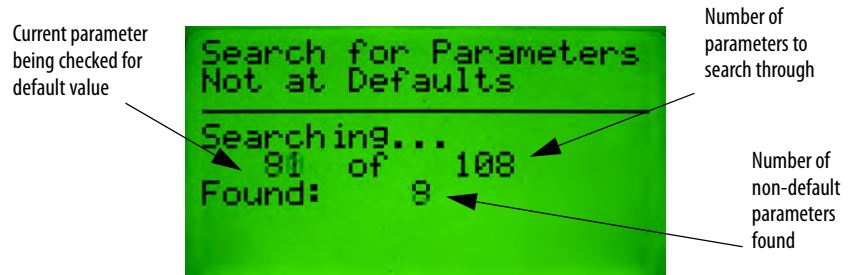

When all the parameters have been checked, a list of parameters that are not at their default value will be displayed. The **Inc** and **Dec** keys allow the operator to move up and down through the non-default parameters. Pressing the **Enter** key allows the parameter value to be viewed/edited.

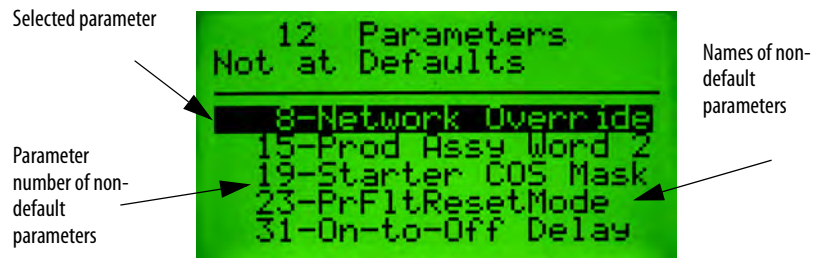

When accessing parameters found by the Search function, the format of the parameter screen will be similar to a Parameter Edit Screen with a few changes. The title line will say “Non-Default Parameter”, and when **Inc** or **Dec** is pressed, only the parameter found in the search will be displayed

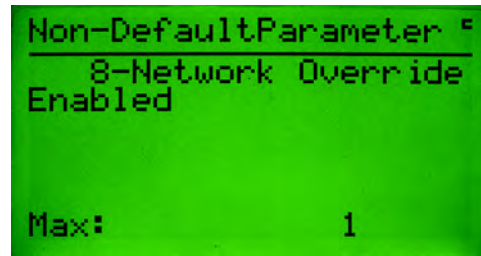

## Parameter Display-Value Enumerated

Certain parameters have enumerated values that are not bit enumerated values, the following screen is displayed and shows the “Raw Value” of the enumerated value.



## Copy Cat Menu

### Copy Cat

The copy cat menu allows the operator to upload and download complete device configurations to and from the Configuration Terminal. For DeviceNet™ slave devices, these complete device configurations consist of all configuration parameter values and any DeviceLogix™ program that is programmed in the device. For Allen-Bradley DeviceNet™ Scanners, device configurations consist of the scan list. This feature is only available for devices that support the Parameter Object or devices that support the Scanner Object.

The Copy Cat menu uses the acronym HIM in many of its menu selections and screens. HIM stands for **H**uman **I**nterface **M**odule and is used to refer to the Configuration Terminal itself. The HIM acronym is used in this product for historical reasons, as this acronym was used on older hand-held configuration tools and many users are familiar with its use with regard to the Copy Cat function.

The Copy Cat Menu is shown below:

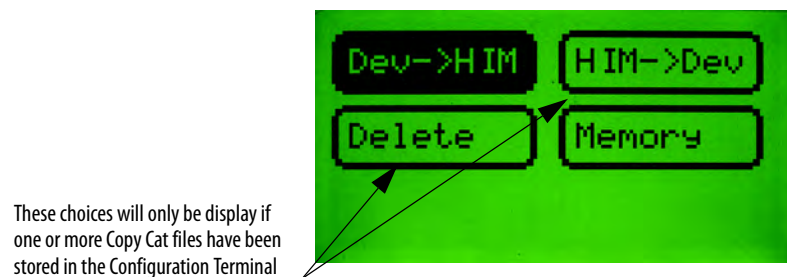

### Copy Cat Uploading

To upload the parameters and the DeviceLogix™ program (or scan list) from a device, select **Dev->HIM** at the Copy Cat Menu and press the **Enter** key. The

first screen will allow the operator to select where the data will be stored, either to an existing file or a new file:



After selecting a file, you will be able to name/rename it:

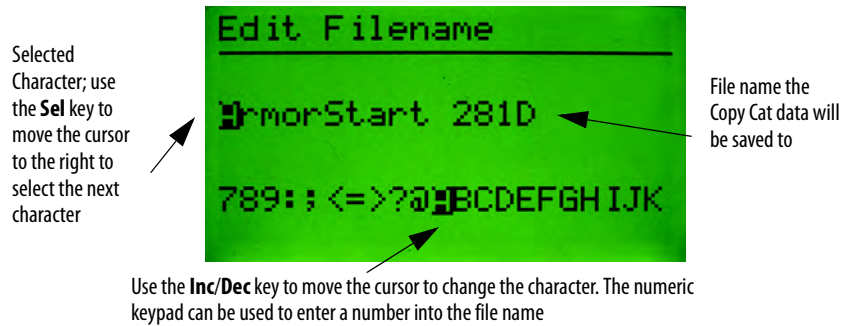

When done editing the file name, press the **Enter** key to start uploading:

Currently uploading parameters. Note: Will display ScanList for Copy Cat of an Allen-Bradley DeviceNet™ Scanner

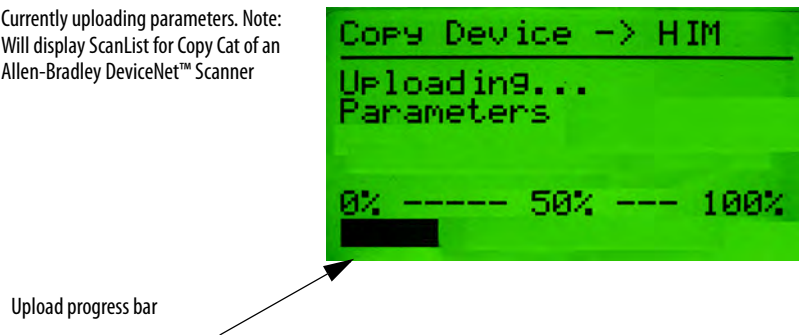

Once the parameters are uploaded, the DeviceLogix™ program will be uploaded (if applicable):

Currently uploading the Logix program

```
Copy Device -> HIM
-----
Uploading...
Parameters Complete
Logix Prgm
0% ----- 50% --- 100%
```

When the upload is complete, the screen will appear as follows:

```
Copy Device -> HIM
-----
Uploading...
Parameters Complete
Logix Prgm Complete
Upload Complete
0% ----- 50% --- 100%
```

## Copy Cat Downloading

To download complete device configuration files that have been stored in the Configuration Terminal, select **HIM->Dev** at the Copy Cat Menu. The first screen that appears will allow the operator to select which stored file to download:

Selected file to download

```
Copy HIM -> Device
ArmorStart 284
ArmorStart 281D
```

After selecting the file to download, press the **Enter** key to start the download. If the device being downloaded to does not match the device the file was uploaded from, an error is displayed before the download continues:

Mismatch type. This could be:  
Vendor  
ProdType  
ProdCode  
Revision

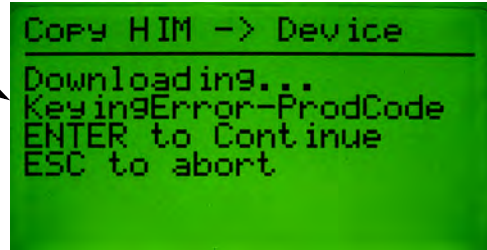

---

**IMPORTANT**

Pressing the **Enter** key will cause the Configuration Terminal to ignore the electronic keying errors and continue the download.

---

The following screen will appear when the downloading starts:

Currently downloading parameters. Note: Will display "ScanList" for copy cat of a scanner

Currently downloading the DeviceLogix™ program

Progress bar

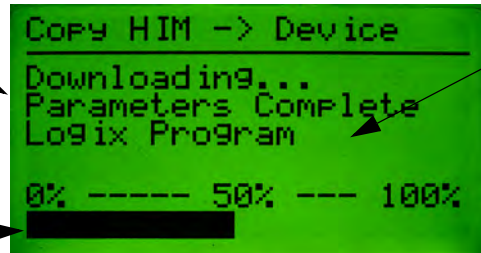

After parameters are downloaded, the DeviceLogix™ program is downloaded.

When the download is complete, the screen will appear as follows:

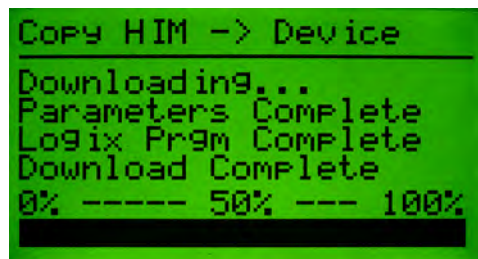

If there are errors during the download process, the screen will look like this:

Errors may occur in either or both parameters and/or the DeviceLogix™ program downloading

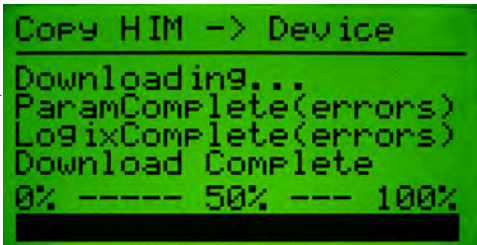

```

COPY HIM -> Device
-----
Downloading...
ParamComplete(errors)
LogixComplete(errors)
Download Complete
0% ----- 50% --- 100%

```

If parameter errors occur, pressing the **Enter** key will bring up the following screen, which will allow the operator to choose to view the parameters that had errors during the download. **Note:** Only the first 32 parameters with errors are stored.

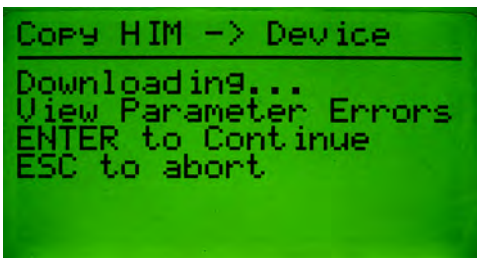

```

COPY HIM -> Device
-----
Downloading...
View Parameter Errors
ENTER to Continue
ESC to abort

```

If the operator chooses to view the parameters that had errors during the download, a Parameter Edit Screen will be displayed with minor changes. The title line will say “CopyCat Error Params,” and when **Inc** or **Dec** is pressed, the user will only view the next parameter that had an error during the download.

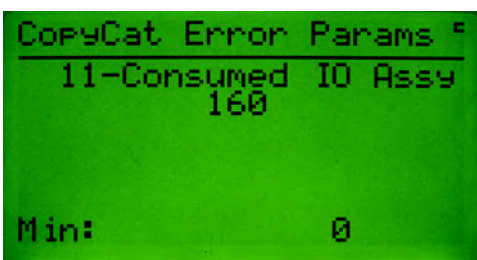

```

CopyCat Error Params
-----
11-Consumed IO Assy
160

Min: 0

```

## Copy Cat Downloading and Product Revisions

From time to time, new firmware revisions are released in the DeviceNet™ product portfolio. Great care is taken in these product upgrades to ensure backward compatibility with previous revisions when it comes to being able to accept Copy Cat data files. Great care is also taken to ensure that the new revision of the product will behave the same as the older revision after a Copy Cat data file has been downloaded.

When a Copy Cat data file is downloaded to a different firmware revision of the same product, the user is made aware of the revision difference as follows:

Pressing the **Enter** key will cause the Configuration Terminal to ignore the revision difference and continue the download

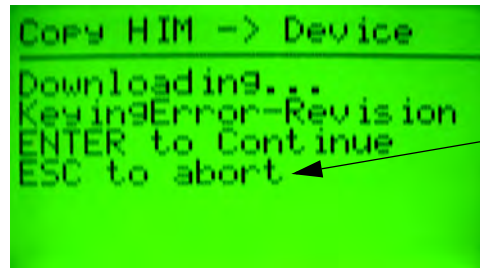

Pressing **ESC** will cause the download to be aborted

In some products, new firmware revisions were released in order to add DeviceLogix™ capability to the product. When downloading a Copy Cat data file that was uploaded from a revision of a product without DeviceLogix™ to a revision of the product that contains DeviceLogix™, the status bar on the Download Status screen will not reach 100%. The “Download Complete” line above the status bar will be the indication that the download was indeed completed.



## Copy Cat Downloading and Product Current Ratings

Often times it is useful to download Copy Cat data files to devices within a product family that have different current ranges. This is particularly useful if the user wishes to download a DeviceLogix™ program to multiple members of a product family. When a Copy Cat data file is downloaded to a product whose

current range is different from that of the product that the data file was uploaded from, the following screen appears:

Pressing the **Enter** key will cause the Configuration Terminal to ignore the product code (current range)

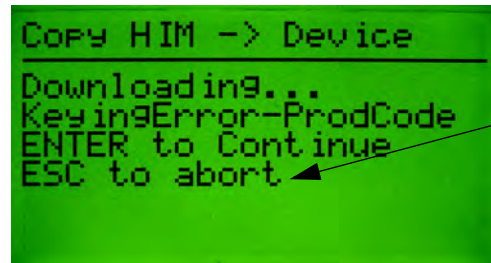

Pressing **ESC** will cause the download to be aborted

When downloading to devices in the same product family with different current ranges, the download results will often include Parameter Errors. These errors are the result of downloading parameters such as FLA current settings whose min/max range is outside the FLA current setting that was downloaded. When this occurs, the following screen appears:

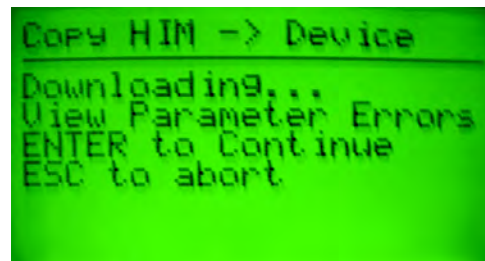

Pressing the **Enter** key will bring the operator to the Parameter Edit Screens for the out-of-range parameters. The title line will say “CopyCat Error Params”.

When **Inc** or **Dec** are pressed from the Parameter Edit Screen, the next or previous parameter that had an error during the download will be displayed





## Deleting Copy Cat Files

Deleting a Copy Cat file from the memory of the Configuration Terminal is done by selecting the Delete option at the Copy Cat Choice menu. Select the file name to delete, and press the **Enter** key to delete the file. If all the files have been deleted, the screen will again display the Copy Cat Choice menu, but the Delete and HIM -> Dev options will not be displayed.

File to be deleted



## Copy Cat Memory

The Copy Cat memory screen displays how many files are stored in the DeviceNet™ HIM and how many blocks of memory are left for copying. The maximum number of files that can be stored in the Configuration Terminal is 31. Depending on the number of parameters in each file, there may not be enough memory to store all 31. **Note:** Each block of memory is equal to 128 bytes in the memory, and there are 128 blocks of memory reserved for file storage.



## DeviceLogix™ Library 5 Support

The 193-DNCT Series B or higher supports the upload/download of a DeviceLogix file. This feature is only available when the device supports the parameter object and DeviceLogix.



## Tools Menu

### Tools Menu

The Tools Menu gives the user access to the Node Commissioning screen, a Class Instance Attribute editor, Graphical parameter chart recorder screen, Assembly menu, and Heartbeat menu. The Tools Menu is shown below:

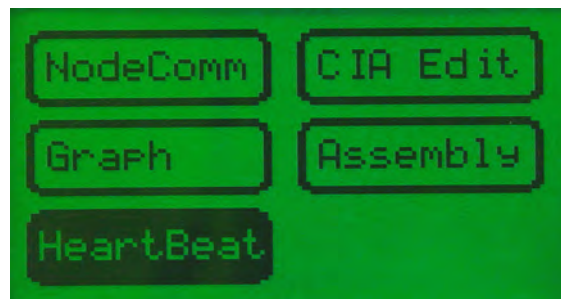

### Node Commissioning

Pressing **Enter** while the NodeComm item is selected in the Tools Menu invokes the Node Commissioning screen. Node commissioning allows the operator to change the Mac ID and/or the baud rate for the currently selected device.

Currently  
selected item

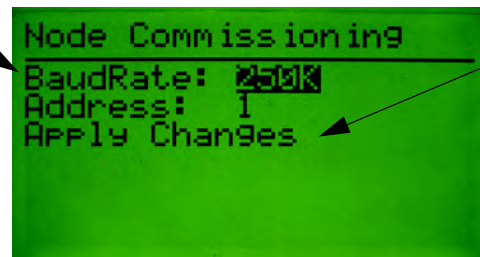

This only appears if one of the fields has been changed. Pressing **Enter** here will reset the DeviceNet™ HIM after writing any changes to the device

### Class Instance Attribute Editor

The Class Instance Attribute (CIA) Editor allows the operator to perform DeviceNet™ explicit messaging. Get, Set, and Reset services can be sent to any Class, Instance, and Attribute.

The Get service is outlined in the following screen description:

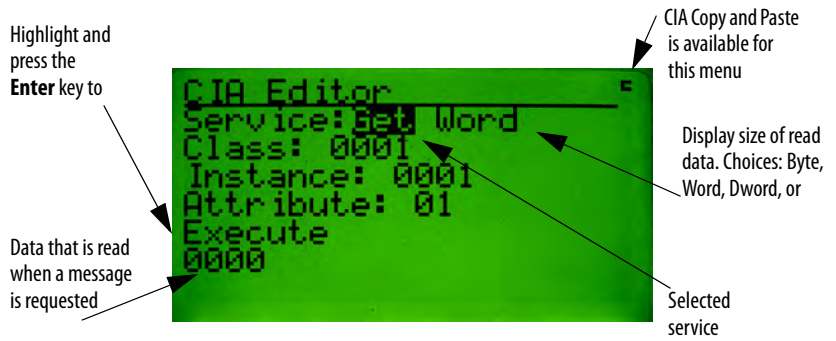

The Set service is outlined in the following screen description:

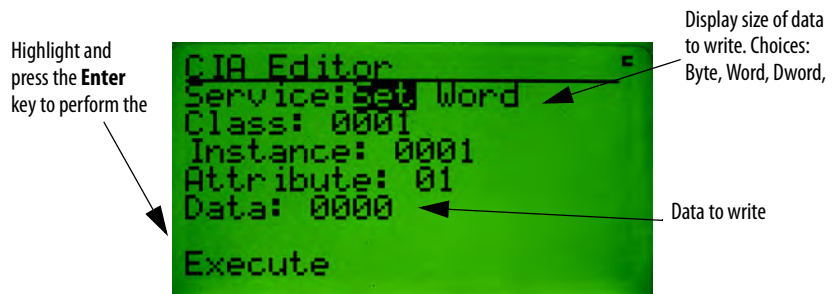

The Reset service is outlined in the following screen description:

Highlight and press the Enter key to perform the Reset service

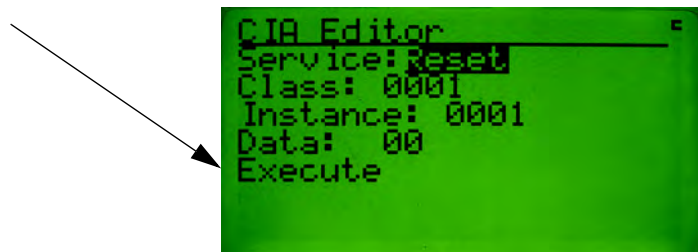

## Graph Setup Screens

The Graph function allows the Configuration Terminal to become a simple graphing device. From the Graph Setup Screens, the user sets up to four Class, Instance, or Attributes to be monitored and displayed as a scrolling graph (similar

to an oscilloscope or chart recorder). The first screen allows the operator to configure the four Class, Instance, or Attributes to be monitored.

The screenshot shows the 'Graph Setup' menu with the following fields: Trace: 11, Class: 15, Instance: 1, Attribute: 1, Max: 100, Min: 0, Offset: 0, and Rate(10mSec): 5. Annotations include: 'Trace number 1-4' pointing to the Trace field; 'CIA Copy and Paste is available for this menu' pointing to the Trace field; 'Class, Instance, Attribute to graph, Note: Traces with the class set to zero will not be graphed.' pointing to the Class field; 'Max is the CIA's value that will be represented as the top of the screen. Min is the CIA's value that will be represented as the bottom of the screen. (In this example, a CIA value of 50 would be in the middle of the screen; any CIA value at or above 100 would be displayed on the top pixel of the screen). Note there are only 64 vertical pixels' pointing to the Max and Min fields; 'Offset is the number of pixels from the bottom of the screen the min value for this trace will be displayed at. The range for this field is 0...64, with 32 being the middle of the' pointing to the Offset field; and 'Rate the CIA will be polled, in 10 mSec increments' pointing to the Rate field.

Press the **Enter** key after the CIA data is configured to display the Graph Trigger Screen. This screen allows the operator to program a trigger point to stop the graph display from updating. The operator can set which trace will be used as the trigger as well as the slope, value, and position of trigger. The trigger point can be disabled if the operator does not need this feature.

The screenshot shows the 'Graph Trigger Setup' menu with the following fields: Trigger: enable, Trace Number: 1, Value: 0, Slope: Positive, and Position: 64. Annotations include: 'This could be trace 1...4' pointing to the Trace Number field; 'The value is the trigger point; this is the raw value obtained by reading the CIA for the selected trace.' pointing to the Value field; 'Position is the location on the screen at which the trigger point will be displayed when the trigger condition is found.' pointing to the Position field; 'Position value is 0...128 (128 pixels across the screen) 64 = 50%' pointing to the Position field; and 'Positive Slope: the raw value (obtained by reading the CIA for the trace) moving from below the Programmed Value to equal or above the Programmed Value. Negative Slope = ' pointing to the Slope field.

Press the **Enter** key after the trigger data is configured to display the Graph View Screen.

## Graph View Screen

This menu displays the CIA data in graphical form.

This screen show only one trace configured

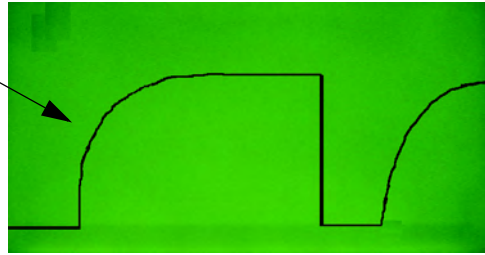

Pressing the **Enter** key while the Graph View Screen is displayed stops the trace and displays a cursor that can be used to view the raw value that was read for that point on the graph.

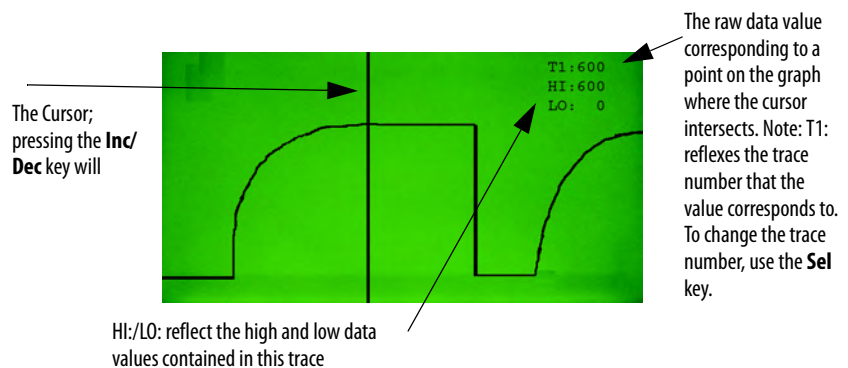

## Assembly Consumed/ Produced Menu

The Assembly choice can be selected from the Tools Menu. This menu allows the user to choose between the consumed (input) and produced (output) assemblies available in the unit.

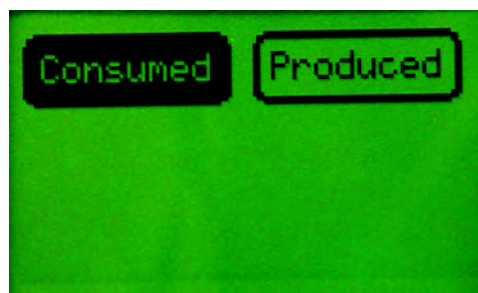

Pressing the **Enter** Key at the “Assembly Consumed / Produced” menu will advance the 193-DNCT to the next menu. This menu lists all of the available assemblies to view. The format for the “Assembly List” menu is as follows:

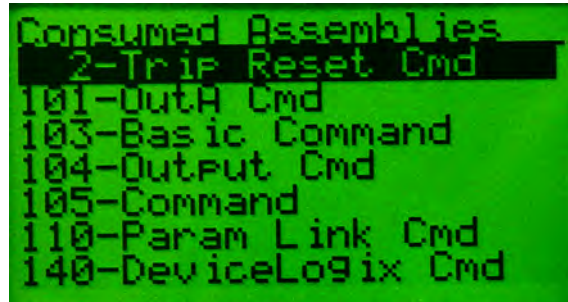

```
Consumed Assemblies
2-Trip Reset Cmd
101-OutA Cmd
103-Basic Command
104-Output Cmd
105-Command
110-Param Link Cmd
140-DeviceLogix Cmd
```

The Assemblies Tag Menu is similar to the IO Tags Menu, however, the data for consumed assemblies can be modified if there is no active IO connections present between the device and the PLC.

**Notes:**

## Advanced Functions Menu

### Advanced Functions Menu

The Advanced Functions Menu provides access to a DeviceLogix™ editor, Zone Interlocking Protocol (ZIP) configuration and monitoring screens, an I/O message timing screen that monitors I/O messaging timing between the selected device and a DeviceNet™ scanner, and Discrete I/O statistics. The Advanced Functions Menu is shown below:

Only available if DeviceLogix™ is supported in the currently selected

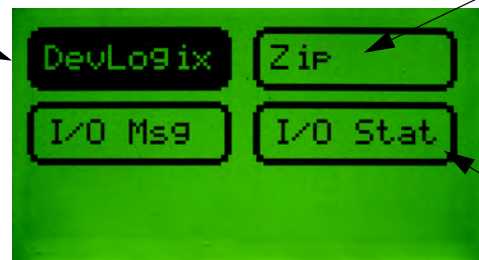

Only available if Zone Interlock Protocol Object is supported in the currently selected device

Only available if DIP, DOP or PNB Objects are supported in the currently selected device

**Notes:**



## HeartBeat Menus

The HeartBeat feature can be found in the Tools Menu



The user can enable or disable the Heartbeat feature and modify the scanning interval from the Setup Menu.

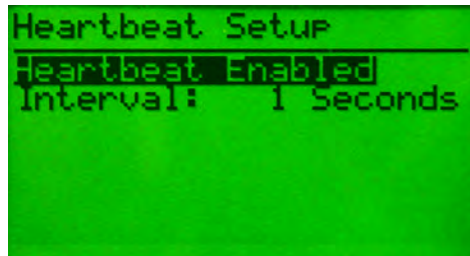

The Heartbeat Monitor menu displays the contents of the last received Heartbeat message. The menu is displayed when the **Monitor** button is pressed on the Heartbeat Choices Menu.

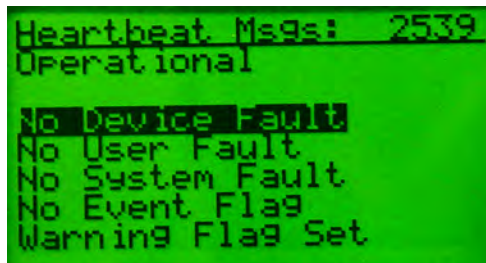

**Notes:**

## I/O Message Monitoring

### I/O Message Monitoring

This screen displays I/O message timing information and I/O message data for the currently selected device. It is accessed by selecting I/O Msg and pressing the **Enter** key at the Advanced Functions Menu.

Press the **INC/DEC** key to switch between consumed and produced data

Type of IO connection. Polled or COS

Size of the I/O data in bytes

I/O Message Count

Message reception rate Min, Max and Average

Most recent produced or consumed I/O data for the currently selected device

```

Consumed I/O Data( 4)
POLLED 16452
Rate: 12.0 mSec
Max: 84.0 mSec
Min: 2.6 mSec
03 01 02 58
    
```

**Notes:**

## DeviceLogix™ Functionality

### DeviceLogix™ Functionality

The Configuration Terminal allows the operator to monitor, edit or delete DeviceLogix™ programs for devices that support DeviceLogix™. DeviceLogix™ can also be enabled or disabled for a device. The DeviceLogix™ functions can be accessed through the DeviceLogix™ Choices Menu, which is accessed by pressing **Enter** from the Advanced Functions Menu while the DevLogix menu item is selected.

### DeviceLogix™ Choices Menu

The DeviceLogix™ Choices Menu is shown below:



### DeviceLogix™ Monitor

This function allows the operator to view a DeviceLogix™ program, including all programmed function blocks, Discrete Output Points (DOP) and Produced Network Bits (PNB). Text string for inputs, outputs, PNBs, and fault bits are displayed for devices that support the DeviceLogix™ Data Table Object. The counter and timer preset and accumulator value's can be modified when selected. To view each function block, use the **INC/DEC** keys to move to the next function block. When the last programmed function block is reached, pressing the **INC** key will advance the screen to the Programmed DOP screen. Pressing the **INC** key again will then display the Programmed PNB screen and if the **INC** key is pressed a third time, the first function block will be displayed again. When viewing Function Blocks, the screen will have the following formats:

### Boolean Gates: AND, OR, XOR, NAND, NOR, NXOR and NOT

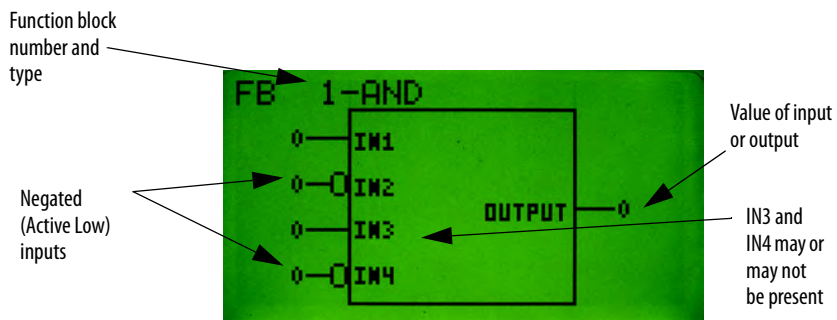

### Bistable Latches: RS Latch and SR Latch

Press the **SEL** key to highlight the function block's inputs and outputs text strings. (Only available if the device supports the DeviceLogix™ Data Table Object)

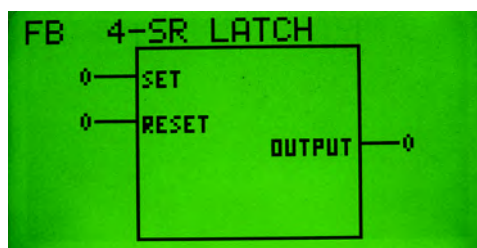

### Counters: Up Counter and Up/Down Counter

Down input may or may not be present

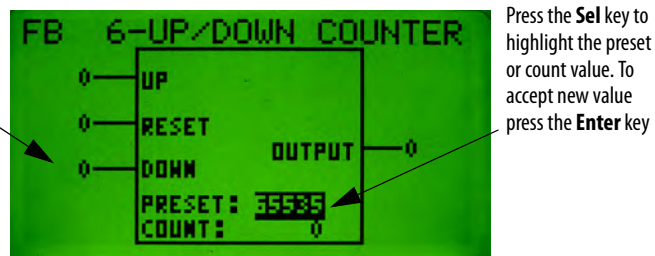

### Timers: On Delay, Off Delay and Pulse Timer

Press the **Sel** key to highlight the preset or count value. To accept a new value press the **Enter** key

Time base: 1 mSec or 10 mSec

### Discrete Output Points (DOPs):

The name of what is driving the Discrete Output Point in the Device Logix program

Discrete Output Point (DOP). The name text for this comes from the product, so names may vary product to product

**Note:** The Programmed DOP screen is only available for devices that support the DeviceLogix™ Data Table Object.

### Produced Network Bits (PNBs):

The name of what is driving the Produced Network Bit in the DeviceLogix™ program

Produced Network Bit (PNB). The name text for this comes from the product, so names may vary product to product.

**Note:** The “Programmed PNB” screen is only available for devices that support the DeviceLogix™ Data Table Object.

## DeviceLogix™ Editor

This DeviceLogix™ Editor allows the operator to create or edit a DeviceLogix™ program. Function blocks are displayed in the same format as in the

DeviceLogix™ Monitor. To create, edit or delete a program element, use the **INC/DEC** keys to navigate to the item to create/edit and then press the **Enter** key. To edit one of the inputs of a function block, use the **SEL** key to highlight the input and then press the **Enter** key. To invoke the DeviceLogix™ Editor, select the Edit item in the DeviceLogix™ Choices Menu and press the **Enter** key.

## Creating a New Function Block

Consider the following example of creating a new AND gate function block. First, invoke the Device Logix editor. One of two displays will appear, either a display of a function block or a screen displaying “No FB’s programmed”. At this point press the **Enter** key and the following screen appears:

The Edit and Delete choices are only present if there are function blocks already programmed

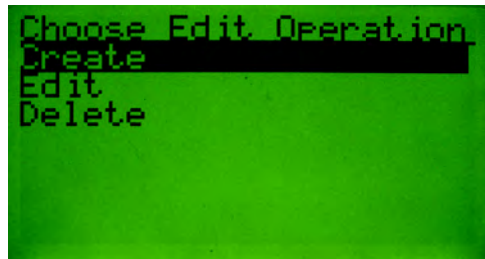

Press the **Enter** key to create a new function block. Now that a new function block has been created, the type of function block must be selected. The following screen will appear:

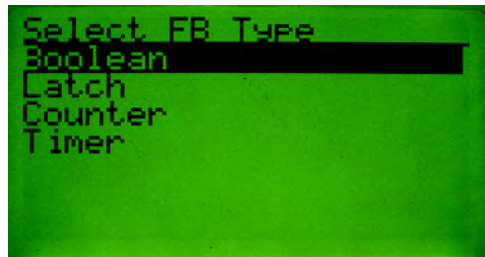

Use the **INC/DEC** keys to select the new function block type. Press the **Enter** key when the desired function block type is selected. The following screen will appear (the Boolean type screen is shown below. Other similar screens appear for other function block types.)





## Function Blocks

The 193-DNCT has function blocks available in the DeviceLogix Library. The DeviceLogix Library version 3 and 5 are available with firmware v2.001 and v3.001, respectively. Devices that use the DeviceLogix Library version 3 or later may enable support for an enable line on each function block. An upgrade to the existing Boolean function block displays the enable line, if the device supports this feature.

The 193-DNCT Series A v2.001 and later are able to display analog function blocks. Each analog function block contains a **PARAM** selection on it, which is used to display and edit additional data that is specific to the type of function block.

*The available analog function blocks are:*

- Arithmetic
- Alarm
- Compare
- Masked Compare
- Timing Diagnostic
- Limit
- Filter
- Select
- Average

Use the **INC/DEC** keys to assign a type to the new function block. Press the **Enter** key when the desired type is selected. The screen should now display a new function block of the selected type:

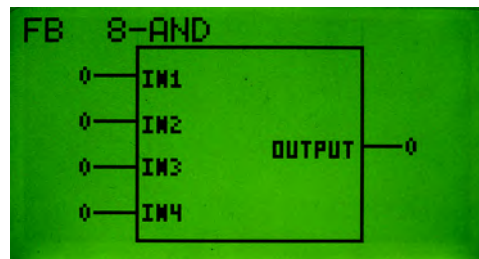

**Note:** At this time a new function block has been created and assigned a type, but the inputs and outputs are not assigned at this time.

## Assigning Source Bits to Function Block Inputs

To assign or edit input source bits for a function block, first choose the function block input by pressing the **Sel** key to scroll through the function block inputs. With each successive **Sel** key press, a different input will be selected on the screen.

Notice that the current source bit assignment for a selected input will be displayed on the screen for three seconds as shown below:

The Assignment text will disappear after three seconds

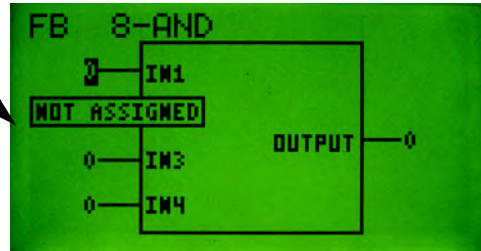

To edit an input source bit assignment, press the **Enter** key while the desired input is selected. The following screen appears:

Negating an input makes the input an active low instead of an active high input

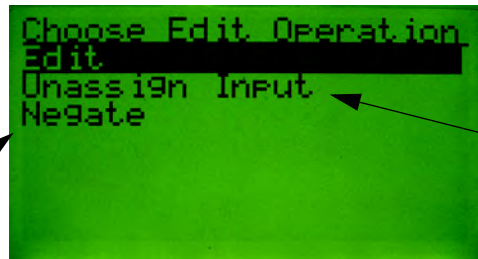

Not all inputs of all function block types can be left unassigned, so this option will not be available for all inputs of all function block

Press the **Enter** key when Edit is selected and the following screen appears:

Not all inputs sources may be supported by all products

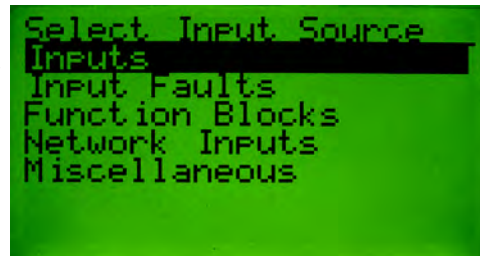

## Discrete I/O Status

### Discrete I/O Status

The Discrete I/O Status screen is displayed by selecting I/O Stat and pressing the **Enter** key at the Advanced Functions Menu. This screen displays the status of any Discrete Input Points (DIP's), Discrete Output Points (DOPs) and Produced Network Bits (PNBs) that are implemented in the currently selected device. This screen will be available if any one of the DIPs, DOPs or PNBs are supported in the currently selected device.

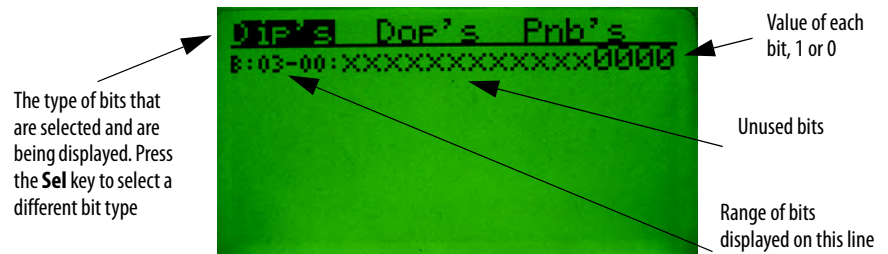

**Note:** In this example the device supports 4 instances of the Discrete Input Point Object.

**Notes:**

## Zone Interlock Protocol (ZIP)

### Zone Interlock Protocol (ZIP)

The Zone Interlock Protocol (ZIP) menu is available for devices that support the DeviceNet™ Zone Interlock Protocol Object. The Zone Interlock Protocol provides a way for devices to share I/O message data directly, and the data that is consumed from other devices can then be used in a DeviceLogix™ program. The ZIP Choices Menu is displayed by selecting ZIP and pressing the **Enter** key at the Advanced Functions Menu. The following menu choices are available to edit and monitor the ZIP configuration:



### ZIP Consumed

This screen allows the operator to configure the ZIP data that the device is going to consume. Configuring ZIP Consumed data consists of mapping I/O data from other nodes or zones on the network to the device's internal ZIP Data Table (the ZIP Data Table is where a DeviceLogix™ program accesses ZIP data). Devices that support ZIP can define the number of zones from which they can consume at one time. In this manual it is assumed that the device can consume data from up to four zones at one time. The size of the internal ZIP data table is device specific. In this manual it is also assumed that the internal ZIP data table is eight bytes long.

The following screen shows a device with no ZIP I/O data configured or mapped:

This is the internal zip data table. B:00-07 indicates that we are viewing data table bytes 0...7 (B:08-15 would be displayed on the next line if the data table was 16 bytes long). Each XX represents one byte in the data table. The XX will display the Devices Node Number whose I/O data is mapped to that byte in the ZIP data table.

The screenshot shows a green terminal window with the following text:
 

```
Consumed Setup Zone x
B:00-07:  XX XX XX XX XX XX XX XX
Node:??
Unused Zones:  4
```

 Annotations with arrows point to:
 

- The title 'Consumed Setup Zone x' and the first line of data.
- The 'Node:??' line.
- The 'Unused Zones: 4' line.

Zone number (1...4) that is associated with data currently highlighted. Note: x = no zone is associated at this time

The Node Number of the device whose I/O data is mapped in this zone

Number of Zones left in this device that are not

## Mapping Consumed ZIP Data

This section explains mapping I/O data for a Zone. Assume that the DeviceNet™ Configuration Terminal is currently configuring Node 11 on the Network. Also assume Node 5 is on the network, and is producing I/O data. Node 11 will be configured to consume the I/O data that Node 5 is producing, which will be done by mapping Node 5 I/O data to Zone 1 in the ZIP data table of Node 11.

First, use the **Left/Right** arrow keys to select the byte in the ZIP data table where Node 5 I/O data will be mapped to.

The selected byte in the ZIP data table is highlighted. In this case Byte 0 is selected. Use the **Right/Left** arrow keys to select the byte

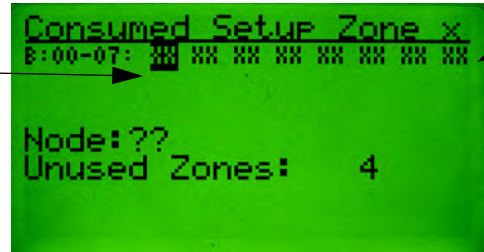

This is Byte 7 of the ZIP internal data table

Once the desired byte in the internal ZIP data table is selected, enter a Node number using the **numeric** keys on the keypad of the node whose I/O is to be mapped (this example maps Node 5 data to byte 0 of the ZIP data table). Press the **Enter** key after the Node Number has been entered and the following display should appear:

Node 5 is mapped to byte 0 of the ZIP data table

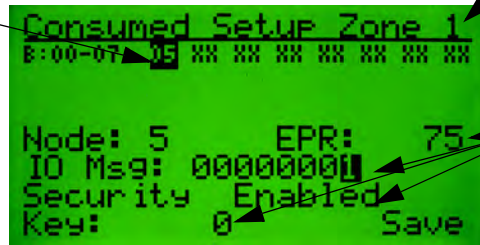

Zone 1 is now configured to Node 5

These are the current ZIP configuration parameters for Zone 1

Use the **Sel** key to highlight the various ZIP configuration parameters for this zone. The following screen shows the Node field highlighted:

The node: Field allows the node number associated with this Zone to be changed

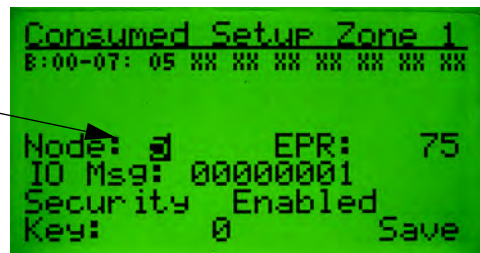

The following screen shows the EPR (Expected Packet Rate) field highlighted:

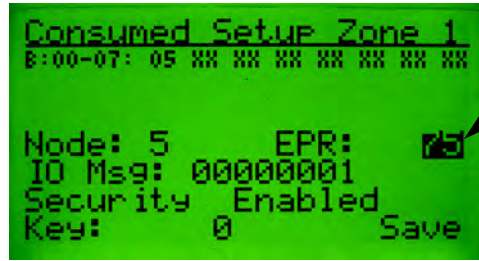

EPR (Expected Packet Rate) allows the expected packet rate of the I/O data from node (Node 5) to be changed. This value is in milliseconds.

The following screen shows the IO Msg field highlighted:

**Note:** The IO Msg field may also be referred to as the Zone Mask field.

The "IO Msg:" field allows the choice of which bytes of the I/O data from node 5 are going to be mapped to the ZIP data table. Each bit in the IO Msg field maps or un-maps a byte of the I/O data from node 5. The value 1 means map this byte of I/O data. In this example, only byte 0 of the I/O data from node 5 is being mapped.

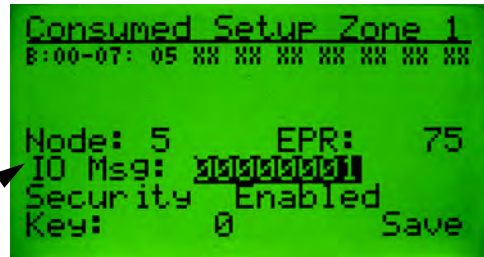

The following screen shows that byte 0 and byte 2 of the I/O data from node 5 are mapped to the ZIP data table. To accomplish this the IO Msg field must be mapped to the value of "00000101". Press the **Enter** key to edit the IO Msg field value. After editing, the value the screen will appear as follows:

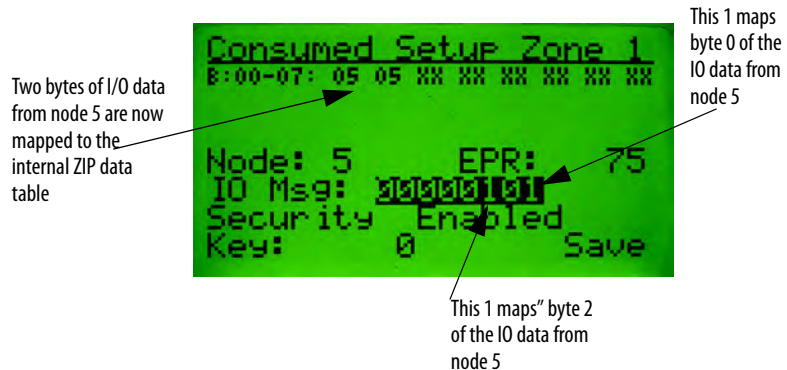

Use the **Sel** key to select the ZIP data table field. Then use the **Right/Left** arrows to select the second byte (the second “05”) in the data table. The display appears as follows:

When each byte in the ZIP data table is highlighted, the bit of the IO Msg field that is Mapped to that byte is also highlighted.

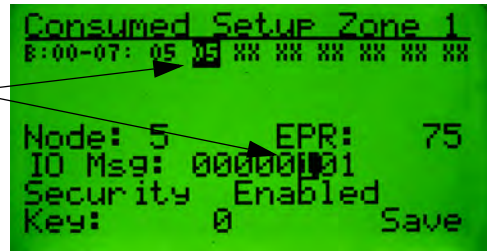

As mentioned earlier, use the **Sel** key to highlight the various ZIP configuration parameters for this zone. The following screen shows the “Security” field highlighted.

This field allows the Security to be enabled or disabled

Note: If Security is disabled, the field for the Key will disappear.



The following screen shows the Zone Security Key field highlighted.

If Security is Enabled, the last 2 bytes of the I/O data from the node (Node 5) must match the Key value. If not, all the consumed I/O data will be ignored.

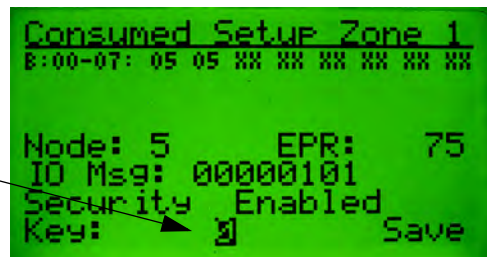



When all edits are complete, the ZIP configuration data must be saved to the device (Node 11 for this example). To save the changes, use the **Sel** key to highlight the Save field and press the **Enter** key.

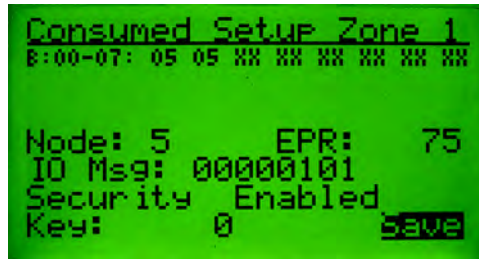

When performing a Save, all the configuration data for all Zones is saved. The Save field will disappear after the save is completed

## ZIP Produced Data

This screen allows the operator to configure the current device to auto-produce I/O data to share with other devices when ZIP is enabled.

Enables or Disables the Auto production of the I/O data for this device. This should be disabled if the device is Zip Disabled /Zip Enabled is the Global Enable for all ZIP functions in the device. This enables or disables ZIP consumption and ZIP production in this

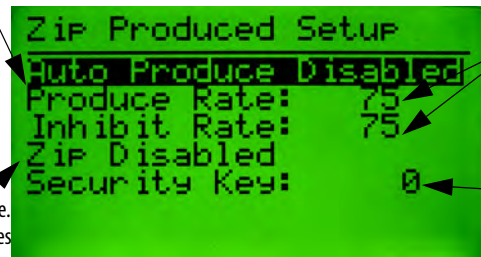

Produce Rate is the cyclic rate at which this device will produce data. Inhibit Rate is the minimum time between Change of State I/O

Security Key is the value of the last 2 bytes of the I/O data produced by this device if security is

## ZIP Data Table Monitor

This function is invoked by selecting Monitor from the ZIP Choices Menu and pressing the **Enter** key. The screen allows the operator to monitor the ZIP data table in order to view the I/O data that the device is consuming. The ZIP Data Table Monitor screen functions as following:

Use the **Right/Left** arrow keys to select individual bytes in the

“Connection Healthy” is displayed if the I/O data is being consumed before the EPR times out. “Connection Unhealthy” will be displayed if the EPR timer for that zone times out or if security is enabled and the Security Key does not match.

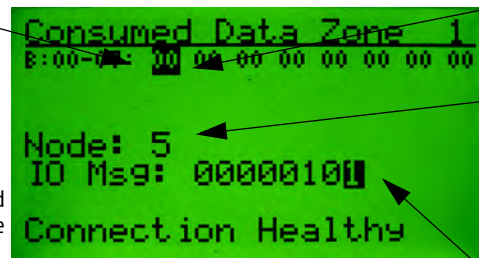

This is the actual data in the internal ZIP data table

Node Number the I/O data is being consumed from for the selected ZIP data table byte

The highlighted bit represents the byte number in the I/O data that is being consumed for the highlighted ZIP data table byte, in this case it is byte 0

Press the **Right/ Left** arrow keys to select the various bytes in the ZIP data table. If no Zone has been mapped to the selected byte in the ZIP data table, the display will appear as follows:

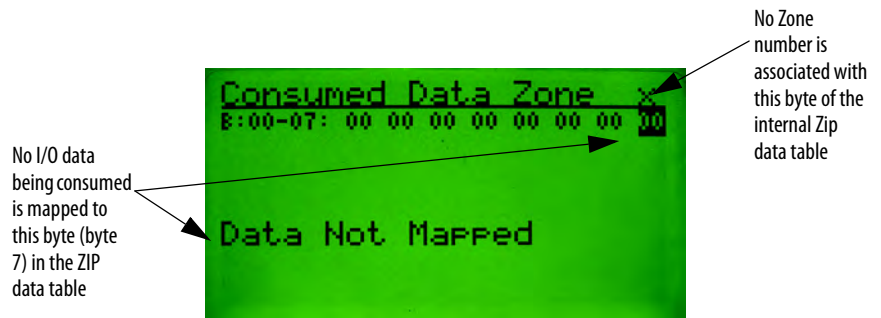

## DeviceNet™ Scanner Menu

### DeviceNet™ Scanner Menu

The DeviceNet™ Scanner Menu is available for Allen-Bradley DeviceNet™ scanners. The scanner menus give the operator some basic information about the scanner's configuration and the ability to adjust a few of the scanner attributes. The scanner menus do not allow the operator to perform complete configuration of a scanner. RSNetWorx for DeviceNet™ must be used for initial scanner configuration for a system. The DeviceNet™ Scanner Menu is invoked from the Device Choices Menu and is shown below:

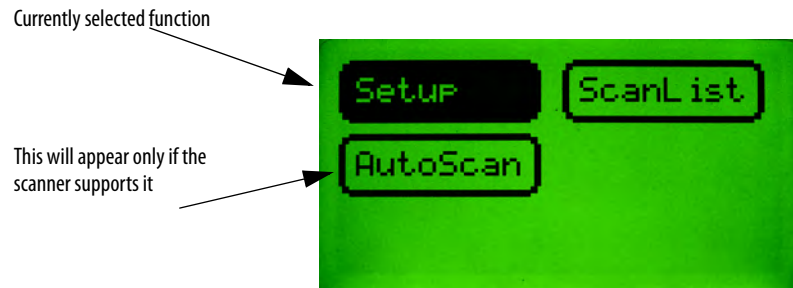

### Scanner Setup

This function allows the operator to view and set some of the global settings of the scanner.

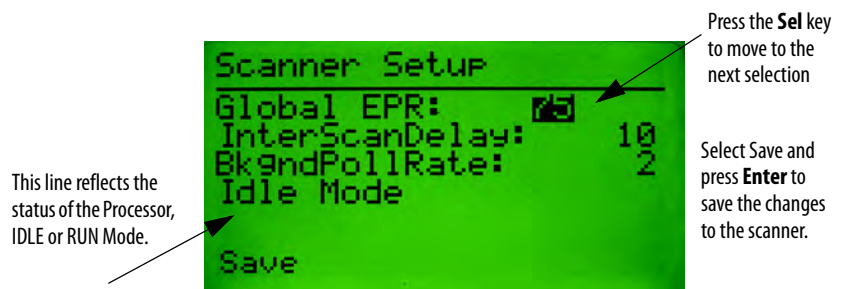

## AutoScan Function

The Auto Scan screen allows the operator to enable and disable the Auto Scan feature of some scanners. This menu will only be available if the scanner supports the Auto Scan function.

This line reflects the status of the Processor, IDLE or

AutoScan must be Disabled to set the mapping size.

Select Save and press **Enter** to save the

The screenshot shows a green terminal window titled "Auto Scan Setup". The text displayed is: "AutoScan: Disable", "Mapping: 4", "Idle Mode", and "Save". A horizontal line is positioned above the "AutoScan: Disable" line. An arrow points from the text "AutoScan must be Disabled to set the mapping size." to the "Disable" text. Another arrow points from "This line reflects the status of the Processor, IDLE or" to the "Idle Mode" text. A third arrow points from "Select Save and press Enter to save the" to the "Save" button.

## ScanList Screen

The ScanList Screen displays a list of the nodes in the scanner's ScanList. It displays the node name, and if it is in the active, faulted or idle state. Use the INC/DEC keys to select nodes in the ScanList.

The selected node

Nodes in ScanList with no errors. When these nodes are selected the product name and "Node Active" will be displayed every other second

A node with errors. The error name and error number will be displayed every other second when these nodes are selected

The screenshot shows a green terminal window titled "ScanList.". The text displayed is: "0-", "1-", "2-ArmorStart", "3-Device Not Active", "4-E3 Plus (9-5000A)", "5-", and "6-". The "0-" line is highlighted with a black bar. An arrow points from "The selected node" to the "0-" line. Two arrows point from "Nodes in ScanList with no errors. When these nodes are selected the product name and 'Node Active' will be displayed every other second" to the "2-ArmorStart" and "4-E3 Plus (9-5000A)" lines. An arrow points from "A node with errors. The error name and error number will be displayed every other second when these nodes are selected" to the "3-Device Not Active" line.

## Node Activation Screen

This screen allows the operator to enable/disable a node from the scanner's scanlist without changing the scanner configuration data for that node (i.e.: I/O mapping, keying, and connection type). To enter this screen, select the correct node in the ScanList screen and press the **Enter** key.

Press **Enter** to perform this operation, if the node is currently enabled in the scanlist this will be displayed

If the Node is currently Disabled in the scanlist, "Enable in ScanList" will appear here

The screenshot shows a green terminal window titled "Node Activation". The text displayed is: "Disable In ScanList". An arrow points from "Press Enter to perform this operation, if the node is currently enabled in the scanlist this will be displayed" to the "Disable In ScanList" text. Another arrow points from "If the Node is currently Disabled in the scanlist, 'Enable in ScanList' will appear here" to the same text.

## Terminal Choices Menu

### Terminal Choices Menu

The Terminal Choices Menu is only displayed when the device selected in the Who Menu is This DeviceNet™ HIM. It is displayed instead of the Device Choices Menu.

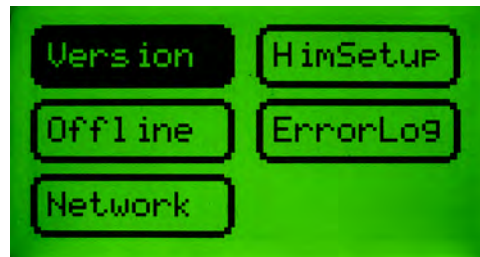

### Version Menu

This screen is displays the revision of the DeviceNet™ Configuration Terminal firmware.

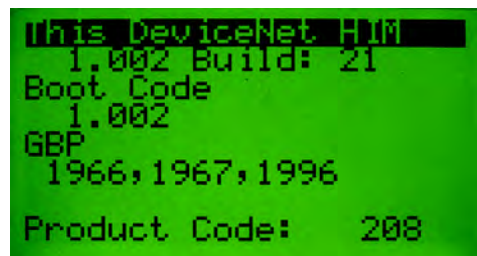

### Offline Connection Set

This function allows the operator to perform Faulted Address Recovery (FAR) for nodes that fail the Duplicate MAC ID test. To get to this function select Offline from the Terminal Choices Menu. The first screen to appear will be the Offline Who Screen, which will request ownership of the Offline Connection Set. When ownership is obtained, it will search for faulted nodes. If any faulted nodes are found, they will be displayed.

Once ownership is obtained, this will change to "Checking for Devices"

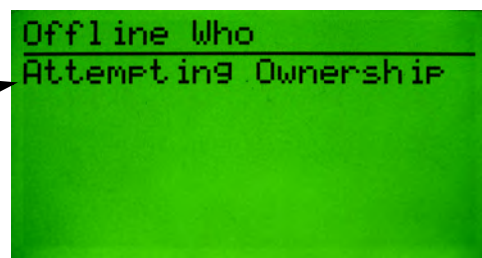

**Note:** It may take up to 10 seconds for the Faulted Address Recovery process to complete.

If no faulted devices are found, the following screen will appear:

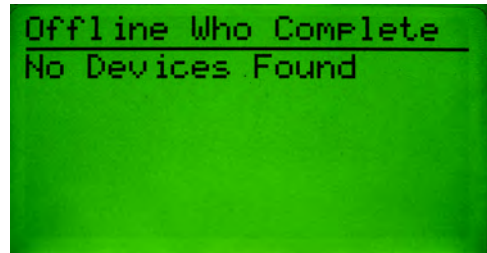

When faulted devices are found, they are reported as follows:

Use the **Inc/Dec** key to select the next device in the list.

**Note:** The selected device's network LED will flash red/green.

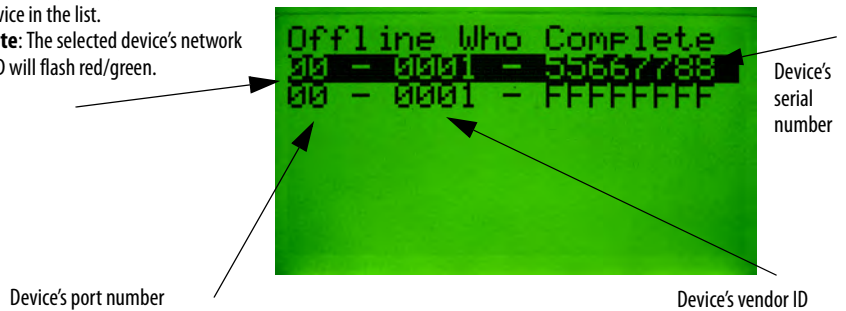

## Offline Change Address Screen

Use the **Inc/Dec** keys in the above screen to select a faulted device. Then pressing the **Enter** key invokes the Offline Change Address Screen. Simply change the device's address and press the **Enter** key while Apply Changes is selected to change the device's address and reset the device.

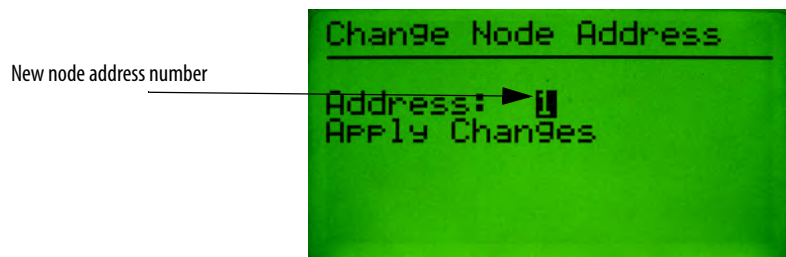

## DeviceNet™ Error Log

The DeviceNet™ Error Log stores the last five errors the Configuration Terminal received when requesting information from a device. If the terminal receives an error that is the same as the last error, only the first error will be stored. Errors received while in the Who Menu are not entered into the error log. Each error has a time stamp associated with it that indicates the number of days, hours, minutes, and seconds since the error message was received. The Error Log screen has the following format:

Node Number,  
Class, Instance,  
and Attribute of  
request for which  
an error was  
returned

Requested Service:

Get Single  
Set Single  
Get All  
Set All  
Reset  
Create  
Delete

```

ErrorLog
Address: 1
Class: 783
Instance: 26
Attribute: 1
Service: Get Single
Obj Does Not Exist
Time: 000:17:55:53
  
```

Time Stamp:  
DDD:HH:MM:SS  
D = Days  
H = Hours  
M = Minutes  
S = Second

This menu  
supports the  
CIA Copy  
function

Error Buffer  
Number, use the  
**Inc/Dec** keys to  
scroll through  
each entry in the  
log.

The Error  
code that  
was returned

## Network Statistics Screen

This screen displays some DeviceNet™ network statistics such as baud rate, actual bus voltage stats, percentage of bus loading stats, CAN errors per second, and total CAN errors. Latching of statistics for some readings begins when the screen is entered, and stops when exiting the screen. Statistics can be cleared by exiting and re-entering the menu. While displaying this screen, the 193-DNCT will not respond to any DeviceNet™ messages directed to it. There will be a short delay when exiting this screen before the Terminal starts producing DeviceNet™ messages, due to the CAN chip being reset and re-initialized. The Network Stats Menu has the following format:

```

BaudRate:          500K
Bus Voltage:      28.59
Bus Voltage Hi:   28.71
Bus Voltage Low:  28.50
Bus % Load:       1.8
Max Bus % Load:  1.8
CAN Errors/Secs:  0
CAN Errors:       0
  
```

**Notes:**



## Terminal Setup Menu

### Terminal Setup Menu

This menu is used to configure features of the 193-DNCT (HIM). The following menu choices are presented:



### Communication Setup Screen (HIM Comm)

This screen is invoked by pressing **Enter** while HIM Comm is selected in the Terminal Setup Menu. It configures how the 193-DNCT connects to the DeviceNet™ network. Three basic options are configured here: the baud rate, the node address, and the power up delay. When configuring the baud rate, auto baud can be enabled or disabled, and the baud rates 125K, 250K or 500K can be selected. When configuring the Node Address, Auto Addressing can be enabled or disabled, and the node address number can be set. When Auto Addressing is enabled the 193-DNCT will operate as follows: the first Dup MacID message will be sent out using the node address that has been configured in the Address Field. If a node is found at that address, the node address is decremented by 1, and the terminal will determine if there is a node at the new address. This will continue until the 193-DNCT finds a node address that is not being used.

The PowerUp Delay field specifies the time waited from initial power up until the first messages are produced by the 193-DNCT. This feature allows the operator to set the time before the 193-DNCT starts communicating with devices on the network, allowing scanners to connect to any group two devices

and start proxying. It also allows all devices to come online before AutoAddressing.

This is the Baud Rate that is used if AutoBaud is disabled

Node Number of the 193-DNCT if AutoAddress is disabled. If AutoAddress is enabled, this is the starting Node Number



PowerUp Delay (in seconds)

## Password Menu

The 193-DNCT has five passwords: one primary (master) password and four secondary passwords. When the primary password has been configured and correctly entered the operator will gain full access to all features in 193-DNCT. The secondary passwords can be configured to limit the features that are associated with that password, so when a secondary password is entered, the operator will only gain access to limited features in the 193-DNCT. The following choices may appear when the Password selection is chosen from the HIM Setup Menu:

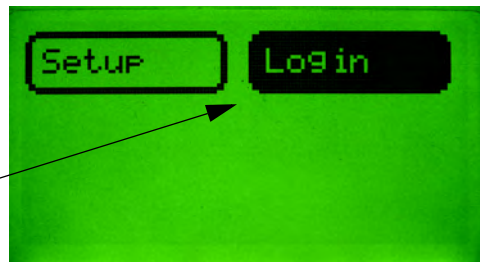

Must have the primary password set for this selection to appear



Must have at least one password logged in for this selection to appear

## Password Setup (Primary)

To activate the primary password, simply set the password to a value other than zero. By logging in using that password value the operator will gain full control of the 193-DNCT. The Password Setup Screen, when set to the Primary Password, has the following format:

Primary Password selected.  
Press the **Inc/Dec** key to get  
to secondary passwords

This will appear when  
changes to the password  
have occurred. Press the  
**Enter** key to save

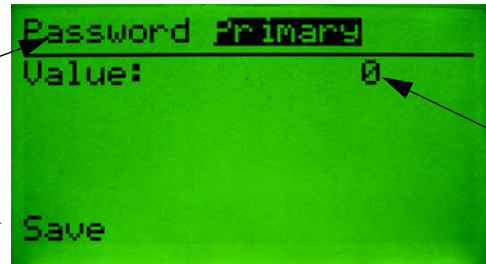

Password value  
range is  
0...999999

## Password Setup (Secondary)

Secondary passwords limit access to certain device features, thus limiting some operator's ability to change the system configuration. The following menu is used to configure secondary passwords:

Secondary password 1 selected

This will appear when  
changes to the password  
have occurred. Press the  
**Enter** key to save

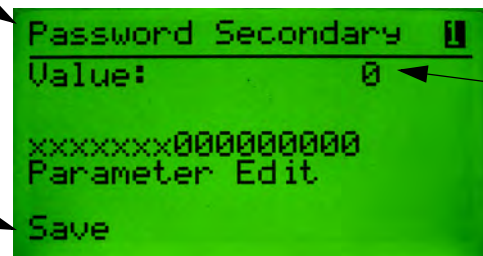

Password value  
range is  
0...999999

To associate privileges to a specific secondary password, press the **Sel** key until the cursor appears on the bit field. Setting a bit to a 1 enables edit privileges for that feature; setting the bit to zero disables editing for that feature. Each of the secondary passwords can be configured to have some or all privileges.

**Note:** Once the primary password is set, it must be logged in to edit secondary passwords.

Bit Field privileges:  
 Bit0 = Parameter Edit  
 Bit1 = CopyCat  
 Bit2 = Graph Setup  
 Bit3 = Node Commissioning  
 Bit4 = CIA Editor  
 Bit5 = DeviceLogix™  
 Bit6 = ZIP  
 Bit7 = Scanner Setup  
 Bit8 = UserKeys

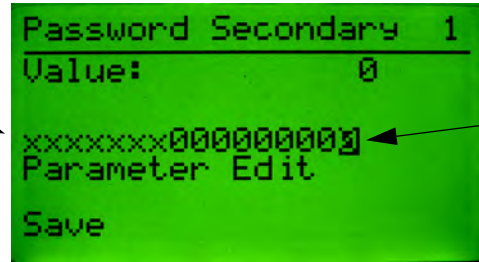

Bit Field selected. Use the Left/Right arrow keys to move the cursor to the next bit. This screen shows bit 0 selected.

### Entering a Password

When the operator attempts to access a menu that is password protected the following box will appear for password entry:



### Resetting Forgotten Passwords

Using RsNetworks for DeviceNet™, find the DNCT on the network, and set parameter 2 - Password Override to override. This will temporarily override the password in the DNCT. The old password can then be viewed and changed from the DNCT. The password is only overridden until the DNCT is powered down.

### Auto Display

The auto display feature allows the 193-DNCT to be setup so that on power up, it will connect to one or more devices and display 1...4 values from 1...4 devices. This allows the unit to automatically monitor device values without any

intervention at power-up. The following choices appear when AutoDspl is selected from the Terminal Setup Menu:

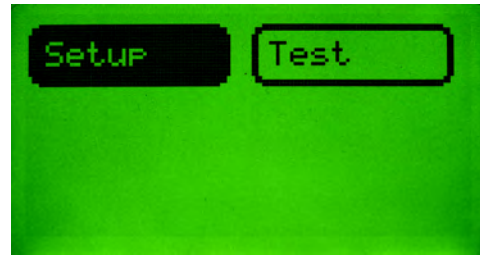

## AutoDisplay Setup

This screen is used to set up to four Class, Instance Attributes to be auto displayed. This screen allows a different node address to be entered for each CIA value configured, thus up to four different nodes can be monitored at the same time. Setting the node address to 64 for a CIA disables Auto Display for that value. Use the **Sel** key to select different fields to edit.

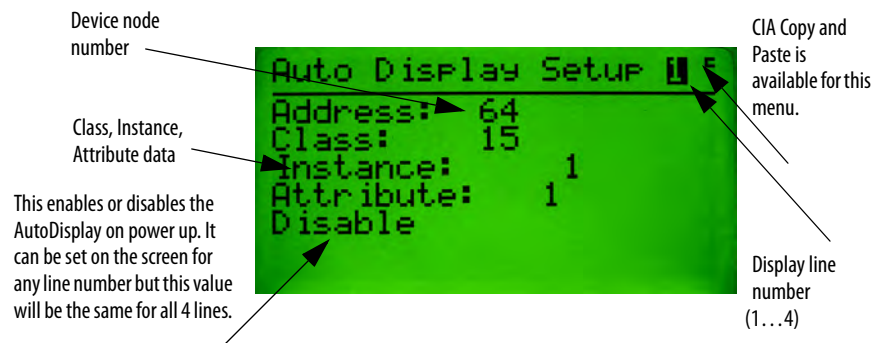

## AutoDisplay Test

This function gives the operator an easy way to view and test the AutoDisplay setup data without powering down the 193-DNCT after setting up each line. If the CIA data for a line points to the parameter class, the 193-DNCT will display the scaled value and units (if any) for that line.

**Note:** AutoDisplay can be configured to show 4 lines as shown here or 1, 2, or 3 lines.



## Programmable User Function Key Setup

The 5 user programmable function keys (**F1**, **F2**, **F3**, **F4** and **Reset**) can be configured to send DeviceNet™ explicit messages when they are pressed. The Function Key Setup screen is used to associate DeviceNet™ messages to the various function keys. This screen is accessed by selecting “UserKeys” in the “Terminal Setup Menu” and pressing the **Enter** key.

The default operation of these keys is identical to the OutA and OutB start keys, and the OutA and OutB stop keys on the old Bulletin 193-PCT hand-held terminal.

- **F1:** Default behavior is like that of the green OutA start key on the 193-PCT. It sets Discrete Output Point instance 1 to the ON state. (CIA: 0x09-0x01-0x03 = 1).
- **F2:** Default behavior is like that of the green OutB start key on the 193-PCT. It sets Discrete Output Point instance 2 to the ON state. (CIA: 0x09-0x02-0x03 = 1).
- **F3:** Default behavior is like that of the red OutA stop key on the 193-PCT. It sets Discrete Output Point instance 1 to the OFF state. (CIA: 0x09-0x01-0x03 = 0).
- **F4:** Default behavior is like that of the red OutB stop key on the 193-PCT. It sets Discrete Output Point instance 2 to the OFF state. (CIA: 0x09-0x02-0x03 = 0).
- **Reset:** Sets Fault Reset to the ON state. (CIA: 0x29-0x01-0x0C = 0).

Each key has the following configuration parameters that can be programmed: Class, Instance, Attribute, Pressed (Down) Value (ON or OFF) and Mode. The Mode can be programmed to either Momentary or Maintained operation. The Maintained Mode acts as follows: when key is pressed, the Press Down Value is sent; when the key is released there is no operation. The Momentary Mode acts as follows: when key is pressed, the Press Down Value is sent; when the key is released, the inverse of the Press Down Value is sent. Since not all screens have an active explicit message connection, the Function Keys will be active while viewing only some menu screens. The following is a list of screens on which the User Keys will be active:

1. Parameter Screen
2. CIA Editor Screen
3. I/O Message Monitoring Screen
4. Graph View Screen
5. Who Menu (Reset key only)

**Table 17.1 Function Key Default Behavior for E3 and ArmorStart**

Function Key	Default E3 Operation	Default ArmorStart Operation
F1	Turns on Output A	Turns on Run Forward
F2	Turns on Output B	Turns on Run Reverse
F3	Turns off Output A	Turns off Run Forward
F4	Turns off Output B	Turns off Run Reverse
Reset	Resets Protection Faults	Resets Protection Faults

## Function Key Setup Screen

Class, Instance, Attribute Information. Values

Current key (F1) being configured. Press **Inc/Dec** to change keys

CIA Copy and Paste is available for this menu

Value sent when the key is pressed, ON (1) or OFF (0)

Mode of key, Momentary or Maintained

Save will appear after changing the settings for any key, Pressing **Enter** will save the information for all the keys

```

User Key: F1
-----
Class: 0009
Instance: 0001
Attribute: 03
Value: ON
Mode: Maintain
Save
    
```

Press **Inc/Dec** from the **F4** setup screen to get to the **Reset** key setup

CIA Copy and Paste is available for this menu

The default for the Reset key is the Clear Fault attribute of the Control Supervisor Object

Class, Instance, Attribute Information. Values are entered in Hexadecimal.

```

Reset Key
-----
Class: 0029
Instance: 0001
Attribute: 0C
Value: ON
Mode: Maintain
    
```

## LCD Contrast

This screen is used to change the contrast of the 193-DNCT LCD. The **Inc/Dec** keys are used to increase or decrease the contrast of the LCD.

Sample text to view when adjusting the contrast

This bar graph indicates the LCD's contrast setting, 0...100%

```

LCD Contrast
-----
4X8 TEXT
6X8 TEXT
0% ----- 50% ----- 100%
    
```

**Notes:**



## Copy and Paste Feature

### Copy and Paste Feature

The 193-DNCT has a Copy and Paste feature that allows the operator to copy Class, Instance, Attribute, Node Number, Min, and Max values from one menu to another menu. Menus that support the Copy and Paste feature will display a small C (copy indication) and P (paste indication) in the upper right hand corner of the screen.

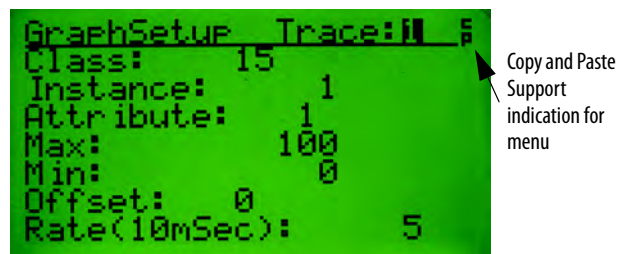

Some screens may only support the copy feature, so only the small **C** in the upper right hand corner will appear. The small **P** in the upper right hand corner will only appear after CIA data has been copied and will only appear on menus that support CIA data paste feature. When a copy or paste is actually performed, the text **Copy** or **Paste** will appear in the upper right hand corner for one second.

To perform a Copy or a Paste use the following key strokes:

To copy the CIA data on a screen:

- Press the **Shift** key, then
- Press the **Copy** key (Right Arrow key)

To paste the CIA data to a screen:

- Press the **Shift** key, then
- Press the **Paste** key (+/- sign key)

In the following example, we will copy the Class, Instance, and Attribute data from a parameter screen to the GraphSetup Screen. First go to the Parameter

Screen and select the parameter to copy. Press the **Shift** key and then the **Copy** key to copy all the parameter data to the clip board.

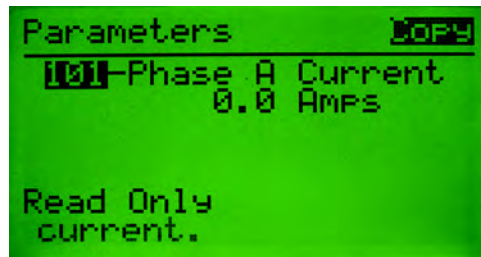

Displayed for one second at the time of the copying. This indicates the copy is complete.

To paste the data to the Graph Setup Menu, invoke the Graph Setup Screen. Next, press the **Shift** key and then press the **Paste** key to paste all the parameter data to the GraphSetup Screen. The screen should appear something like this, depending on the parameter copied:

Class, Instance, Attribute, Min and Max value should change to the settings of the copied parameter

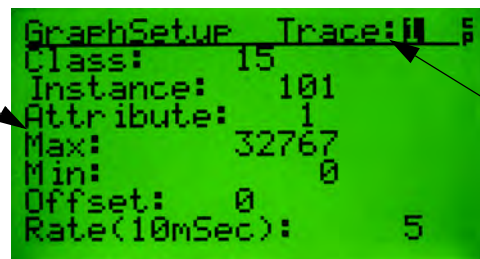

"Paste" is displayed here for 1 second at the time of the paste. The display disappears when the paste is complete.

The follow table documents which menus support the copy and/or paste feature:

SCREEN	COPY Support	PASTE Support
Parameter	YES	NO
CIA Editor	YES	YES
Graph Setup	YES	YES
Error Log	YES	NO
AutoDisplay Setup	YES	YES
Function Key Setup	YES	YES

## Menu Help Feature

### Menu Help Feature

All of the screens in the DeviceNet™ Configuration Terminal have help text associated with them. To view help text, press the **Shift** key followed by the **Help** key (Zero key). Press the **ESC** or **Enter** key to close the help screen. Some menus that are complicated, such as graph setup, have help available for each field on the screen. In those cases, select a field and press the **Shift** key followed by the **Help** (Zero) key. The following is an example of a help screen:

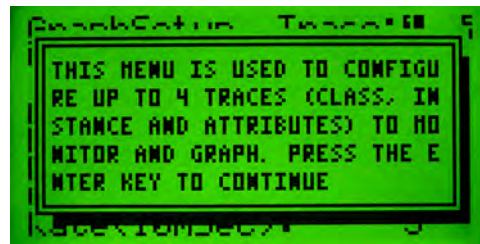

**Notes:**

## Specifications

<b>Display</b>	
Display Type	128 x 64 LCD with yellow-green backlighting
Viewing Area	57 x 30 mm (2.24 x 1.18 in.)

<b>Keypad</b>	
Keypad Type	Tactile embossed, domed keys, sealed membrane
Operation Force	453 g (16 oz)
Operational Life	1 million operations

<b>Communications</b>	
Communication Protocol	DeviceNet™ (125, 250, 500 Kbaud selectable)

<b>Electrical</b>	
Input Voltage Range	11...25.0V DC
Input Power, typical	1.7 W
Input current	70 mA @ 24V DC

<b>Environmental</b>	
Operating Temperature	0...50°C (32...122°F)
Storage Temperature	-40...85°C (-40...185°F)
Humidity	5...95% non condensing
Operating Shock	30 g
Non-Operating Shock	50 g
Operating Vibration	2.5 g @ 5Hz...2kHz
Non-Operating Vibration	5 g @ 5Hz...2kHz

<b>Dimensions</b>	
Height	116 mm (4.57 in)
Width	70 mm (2.76 in)
Depth	15.5 mm (.67 in)
Weight	85 g (3 oz)

<b>Agency Approvals</b>	
UL	508
cUL	
CSA	C22.2 No. 14
CE	EN61000-6-2:2005 EN61000-6-4:2001
RoHS	This product meets the material restrictions of the European Union RoHS Directive

## DeviceNet™ Objects

The following object classes are supported:

Class	Object
0x0001	Identity
0x0002	Message Router
0x0003	DeviceNet™
0x0005	Connection

### Identity Object

#### CLASS CODE 0x0001

The following class attributes are supported for the Identity Object:

Attribute ID	Access Rule	Name	Data Type	Value
1	Get	Revision	UINT	1

Each instance of the Identity Object contains the following attributes:

Attribute ID	Access Rule	Name	Data Type	Value
1	Get	Vendor	UINT	1 or 625
2	Get	Device Type	UINT	115 - Generic Type
3	Get	Product Code	UINT	208
4	Get	Revision Major Revision Minor Revision	Structure of: USINT USINT	
5	Get	Status	WORD	Bit 0 - 0=not owned; 1=owned by master Bit 2 - 0=Factory Defaulted; 1=Configured Bit 8 - Minor Recoverable fault Bit 9 - Minor Unrecoverable fault Bit 10 - Major Recoverable fault Bit 11 - Major Unrecoverable fault
6	Get	Serial Number	UDINT	unique number for each device
7	Get	Product Name String Length ASCII String	Structure of: USINT STRING	"DeviceNet™ HIM" or "Boot Code"

The following common services are implemented for the Identity Object:

Service Code	Implemented for:		Service Name
	Class	Instance	
0x0E	No	Yes	Get_Attribute_Single
0x05	No	Yes	Reset
0x10	No	No	Set_attribute_Single

## Message Router

### CLASS CODE 0x0002

No class or instance attributes are supported. The message router object exists only to rout explicit messages to other objects.

## DeviceNet™ Object

### CLASS CODE 0x0003

The following class attributes will be supported for the DeviceNet™ Object:

Attribute ID	Access Rule	Name	Data Type	Value
1	Get	Revision	UINT	2

A single instance of the DeviceNet™ Object (instance 1) will be supported. The following instance attributes will be supported.

Attribute ID	Access Rule	Name	Data Type	Value
1	Get	Node Address	USINT	0...63

The following services will be implemented for the DeviceNet™ Object.

Service Code	Implemented for:		Service Name
	Class	Instance	
0x0E	Yes	Yes	Get_Attribute_Single
0x10	No	No	Set_Attribute_Single



## Connection Object

### CLASS CODE 0x0005

No class attributes are supported for the Connection Object.

Multiple instances of the Connection Object are supported for explicit UCMM connections.

Attribute ID	Access Rule	Name	Data Type	Value
1	Get	State	USINT	0=nonexistent 1=configuring 3=established 4=timed out
2	Get	Instance Type	USINT	0=Explicit Message
3	Get	Transport Class Trigger	USINT	0x83 - Server, Transport Class 3
4	Get	Produced Connection ID	UINT	Depends on message group and Message ID
5	Get	Consumed Connection ID	UINT	Depends on message group and Message ID
6	Get	Initial Comm Characteristics	USINT	0x33 (Group 3)
7	Get	Produced Connection Size	UINT	0
8	Get	Consumed Connection Size	UINT	
9	Get/Set	Expected Packet Rate	UINT	in milliseconds
12	Get	Watchdog Action	USINT	01 = auto delete 03 = deferred delete
13	Get	Produced Connection Path Length	UINT	0
14	Get	Produced Connection Path		Empty
15	Get	Consumed Connection Path Length	UINT	0
16	Get	Consumed Connection Path		Empty

**Notes:**



## Rockwell Automation Support

Rockwell Automation provides technical information on the Web to assist you in using its products.

At <http://www.rockwellautomation.com/support>, you can find technical manuals, technical and application notes, sample code and links to software service packs, and a MySupport feature that you can customize to make the best use of these tools. You can also visit our Knowledgebase at <http://www.rockwellautomation.com/knowledgebase> for FAQs, technical information, support chat and forums, software updates, and to sign up for product notification updates.

For an additional level of technical phone support for installation, configuration, and troubleshooting, we offer TechConnect<sup>SM</sup> support programs. For more information, contact your local distributor or Rockwell Automation representative, or visit <http://www.rockwellautomation.com/support/>.

## Installation Assistance

If you experience a problem within the first 24 hours of installation, review the information that is contained in this manual. You can contact Customer Support for initial help in getting your product up and running.

United States or Canada	1.440.646.3434
Outside United States or Canada	Use the <a href="http://www.rockwellautomation.com/support/americas/phone_en.html">Worldwide Locator</a> at <a href="http://www.rockwellautomation.com/support/americas/phone_en.html">http://www.rockwellautomation.com/support/americas/phone_en.html</a> , or contact your local Rockwell Automation representative.

## New Product Satisfaction Return

Rockwell Automation tests all of its products to ensure that they are fully operational when shipped from the manufacturing facility. However, if your product is not functioning and needs to be returned, follow these procedures.

United States	Contact your distributor. You must provide a Customer Support case number (call the phone number above to obtain one) to your distributor to complete the return process.
Outside United States	Please contact your local Rockwell Automation representative for the return procedure.

## Documentation Feedback

Your comments will help us serve your documentation needs better. If you have any suggestions on how to improve this document, complete this form, publication [RA-DU002](#), available at <http://www.rockwellautomation.com/literature/>.

**[www.rockwellautomation.com](http://www.rockwellautomation.com)**

---

### Power, Control and Information Solutions Headquarters

Americas: Rockwell Automation, 1201 South Second Street, Milwaukee, WI 53204-2496 USA, Tel: (1) 414.382.2000, Fax: (1) 414.382.4444

Europe/Middle East/Africa: Rockwell Automation NV, Pegasus Park, De Kleetlaan 12a, 1831 Diegem, Belgium, Tel: (32) 2 663 0600, Fax: (32) 2 663 0640

Asia Pacific: Rockwell Automation, Level 14, Core F, Cyberport 3, 100 Cyberport Road, Hong Kong, Tel: (852) 2887 4788, Fax: (852) 2508 1846