



ALLEN-BRADLEY

1336 FORCE™ Field Oriented Control

5.5-370kW/7.5-500HP

User Manual (Series A)

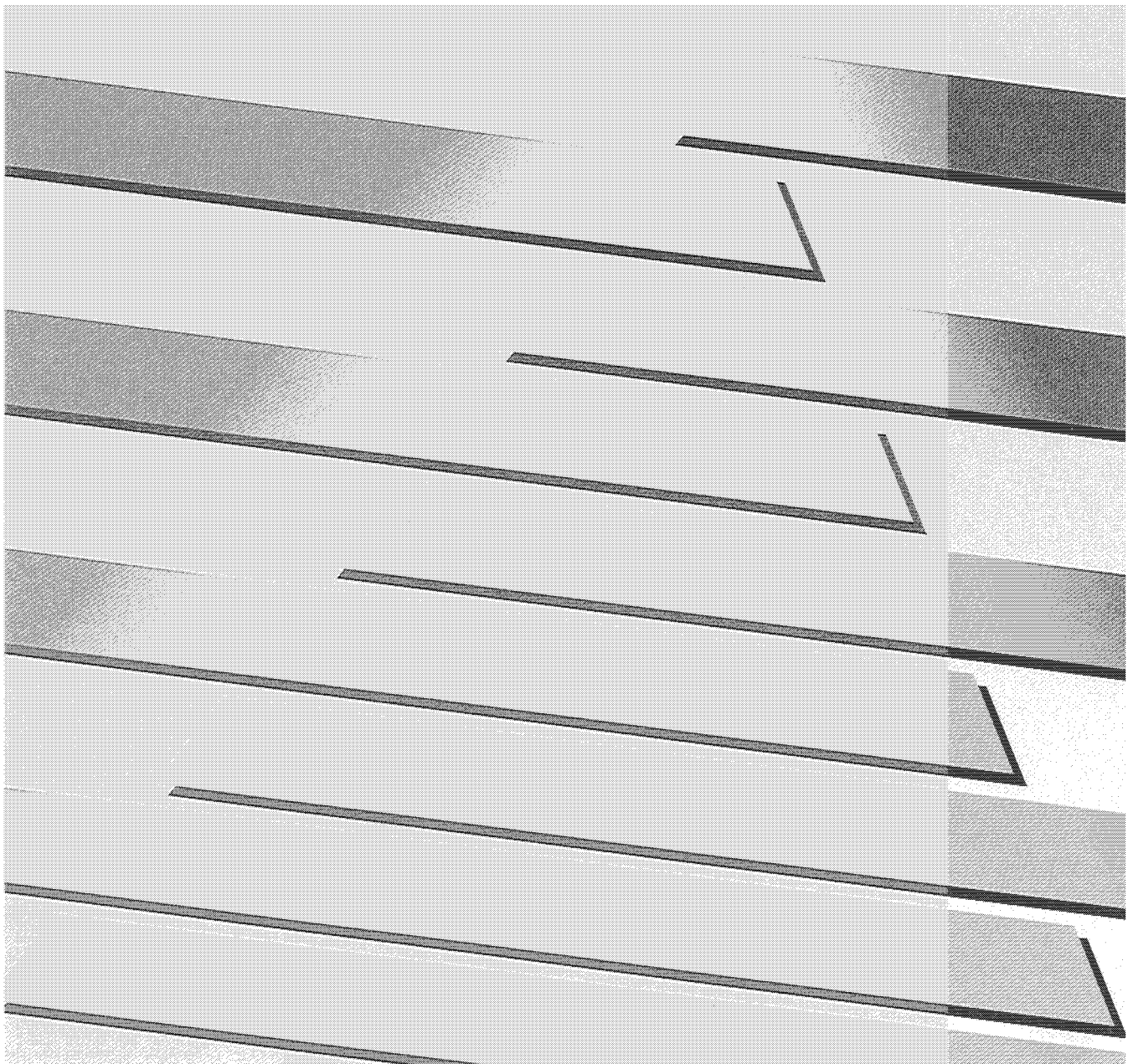

Important User Information

Because of the variety of uses for this equipment and because of the differences between this solid-state equipment and electromechanical equipment, the user of and those responsible for applying this equipment must satisfy themselves as to the acceptability of each application and use of the equipment. In no event will Allen-Bradley Company be responsible or liable for indirect or consequential damages resulting from the use or application of this equipment.

The illustrations shown in this manual are intended solely to illustrate the text of this manual. Because of the many variables and requirements associated with any particular installation, the Allen-Bradley Company cannot assume responsibility or liability for actual use based upon the illustrative uses and applications.

No patent liability is assumed by Allen-Bradley Company with respect to use of information, circuits or equipment described in this text.

Reproduction of the content of this manual, in whole or in part, without written permission of the Allen-Bradley Company is prohibited.

The information in this manual is organized in numbered chapters. Read each chapter in sequence and perform procedures when you are instructed to do so. Do not proceed to the next chapter until you have completed all procedures.

Throughout this manual we use notes to make you aware of safety considerations:



ATTENTION: Identifies information about practices or circumstances that can lead to personal injury or death, property damage or economic loss.

Attentions help you:

- Identify a hazard.
- Avoid the hazard.
- Recognize the consequences.

Important: Identifies information that is especially important for successful application and understanding of the product.



Shock Hazard labels may be located on or inside the drive to alert people that dangerous voltage may be present.

Introduction

Chapter 1

Manual Objectives 1-1
Who Should Use This Manual 1-1
Terminology 1-1
Standard Drive Features 1-2
Performance Specifications 1-2
Options 1-2
Protective Features 1-3
Environmental Specifications 1-3
Electrical Specifications 1-3
Feedback Devices 1-4

Installation/Wiring

Chapter 2

Chapter Objectives 2-1
Mounting 2-1
Dimensions 2-2
Input Power Conditioning 2-5
AC Supply Source 2-5
Power Wiring 2-5
Grounding Procedures 2-6
Wire Size and Type 2-8
Lug Kits 2-10
AC Input Line Fuses 2-11
Drive Output Disconnection 2-11
Control Wiring 2-12
Encoder Connections 2-13
Brake Control Connections 2-13
CAN Connections 2-13
Power Wiring 2-14
Control & Signal Wiring 2-22
Switch Settings 2-23
Starting & Stopping the Motor 2-24

Start-Up

Chapter 3

Introduction 3-1
Safety Precautions 3-1
Required Tools & Equipment 3-2
Drive Information 3-3
General 3-4
Pre-Power Checks 3-4
Communication Configuration 3-5
Power-On Checks 3-9
Startup Configuration Procedure 3-11

Troubleshooting

Chapter 4

General 4-1
Required Equipment 4-1
Fault Descriptions 4-2
Fault /Warning Handling 4-6
Motor Control Board Faults & Warnings 4-6
Current Processor Faults & Warnings 4-8
Velocity Processor Faults & Warnings 4-12
Auto-Commissioning Test Procedure 4-15
Velocity Loop Autotune 4-27
Power Device Troubleshooting 4-29

Programming Parameters

Chapter 5

Introduction 5-1
Terminology 5-2
Parameter Table Structure 5-3
Parameter Table (Numerical) 5-4
Parameter Descriptions 5-9
PLC Comm Parameters 5-51

Derating Information

Appendix A

General A-1
Derating Guidelines A-2
Carrier Frequency and Ambient Temperature Derating A-2
Altitude Derating A-5
High Input Voltage Derating A-5

Introduction

Manual Objectives

The purpose of this manual is to provide the user with the necessary information to install, program, start up and maintain the 1336 FORCE Digital AC Drive. This manual should be read in its entirety before operating, servicing or initializing the 1336 FORCE Drive.

Who Should Use This Manual

This manual is intended for qualified service personnel responsible for setting up and servicing the 1336 FORCE AC Drive. You must have previous experience with and a basic understanding of electrical terminology, programming procedures, required equipment and safety precautions before attempting any service on the 1336 FORCE Drive.



ATTENTION: Only personnel familiar with the 1336 FORCE Drive and the associated machinery should plan or implement the installation, start-up, and subsequent maintenance of the Drive. Failure to comply may result in personal injury and/or equipment damage.



ATTENTION: An incorrectly applied or installed Drive can result in component damage or a reduction in product life. Wiring or application errors such as undersizing the motor, incorrect or inadequate AC supply or excessive ambient temperatures may result in damage to the Drive or motor.



ATTENTION: This Drive contains ESD (Electrostatic Discharge sensitive parts and assemblies. Static control precautions are required when installing, testing, servicing or repairing this assembly. Component damage may result if ESD control procedures are not followed. If you are not familiar with static control procedures, reference Allen-Bradley Publication 8000-4.5.2, *Guarding against Electrostatic Damage* or any other applicable ESD protection handbook.

Terminology

Detailed definitions of industrial automation and technical terms used throughout this manual may be found in the **INDUSTRIAL AUTOMATION GLOSSARY – a guide to Allen-Bradley technical terms**, Publication AG-7.1.

Standard Drive Features

The Bulletin1336 FORCE Field Oriented AC Drive is a microprocessor controlled Digital AC Drive with the following features:

- 7.5 to 500 HP four quadrant operation at 0 – 250 HZ constant torque
- High Performance Digital Velocity Loop
- Microprocessor controlled, field oriented current loop
- Simplified programming through the use of a Parameter Table that features data entries in engineering units with English descriptions
- Nonvolatile Parameter Storage
- Extensive diagnostics, including both logic board and power structure tests
- Time stamped nonvolatile Fault/Warning Queue
- Real Time Clock
- Reference Time Stamp
- Run Time Accumulator
- Enclosed construction
- Multiple Communication Interfaces
- Complete Encoder Interface
- Drive to Drive Interface

Performance Specifications

- Speed Regulation to 0.001% of top speed.
- Torque Regulation to $\pm 5\%$ of rated motor torque.
- Power Loss Ride-Thru capability of two seconds.
- Flying Start: Capability of starting into a spinning motor.
- Torque Linearity 1%

Options

- PLC Communication Adapter Board which provides:
 - 4 Analog Inputs +/-10V
 - 4 Analog Outputs +/- 10V
 - +/- 10V Reference voltages
 - RIO/DHTM+ Communications (2 channels selectable)
 - Function Blocks
 - Trending
- DriveToolsTM; PC WindowsTM based programming software compatible with the 1336 FORCE Drive and also other Allen-Bradley 1336 and 1395 products.
- Dynamic Braking
- AC Motor Contactor

Protective Features

The 1336 FORCE Drive incorporates the following protective measures:

- Programmable Motor Overload Protection (I^2T) investigated by UL to comply with NEC Article 430.
- Programmable Inverter Overload Protection (IT)
- Overspeed Detection, even when operating as a torque follower.
- Programmable Stall Detection
- Peak output current monitoring to protect against excessive current at the output due to a phase to ground or phase to phase short.
- Ground fault monitoring
- DC Bus Voltage monitoring to protect against under/over voltage conditions.
- Motor Temperature Estimator
- Power Structure Heatsink Temperature Monitoring

Environmental Specifications

The following environmental guidelines apply to both the 1336 FORCE Drive and all devices and accessories connected to the Drive.

- Ambient Operating Temperature:
 - IP00, Open: 0 to 50 degrees C (32 to 122 degrees F).
 - IP20, NEMA Type 1 Enclosed: 0 to 40 degrees C (32 to 104 degrees F).
 - IP65, NEMA Type 4 Enclosed: 0 to 40 degrees C (32 to 104 degrees F).
- Storage Temperature (all constructions):
 - 40 to 70 degrees C (-40 to 158 degrees F).
- Relative Humidity: 5 – 95% non-condensing
- Altitude: 1000m (3300 ft) without derating.
- Shock: 15g peak for 11ms duration (± 1.0 ms).
- Vibration: 0.0006 inches (0.152 mm) displacement. 1G peak.

Electrical Specifications

- Input Voltage Rating:
 - 200 – 240VAC, Standalone, 3 Phase, +10%, -15% nominal
 - 380 – 480VAC, Standalone, 3 Phase, +10%, -15% nominal
 - 500 – 600VAC Standalone, 3 Phase, +10%, -15% nominal
 - 513 – 621 VDC, Common Bus, +10%, -15% nominal
 - 776 VDC, Common Bus, +10%, -15% nominal
- Input Power Rating:
 - 10 – 134 KVA (230V)
 - 9 – 437 KVA (380V)
 - 12 – 552 KVA (460V)
 - 9/11 – 575/690 KVA (500/600V)

- Input Frequency: 50/60HZ (± 3 HZ)
- Standard Output Voltage*: Three frame sizes are available. Each frame size is line dependent and can power a motor between the following voltages:
 - 200 – 240 Vac (line dependent)
 - 380 – 480 Vac (line dependent)
 - 500 – 600 Vac (line dependent)*If voltage required for your application is not shown, contact Allen-Bradley for specific application.
- Output Current: 17 – 625A
- Output Power: 6.8 – 115 KVA (230V)
 - 11 – 190 KVA (380V)
 - 12 – 208 KVA (415V)
 - 13.5 – 231 KVA (460V)
 - 17 – 289 KVA (575V)
- Output Horsepower (Continuous): 7.5 – 500HP
- Overload Capability:
 - Continuous – 100% Fundamental current
 - 1 minute – 150%
- Output Frequency Range: 0 – 250 HZ
- Output Waveform: Sinusoidal (PWM)
- Max. Short Circuit Current Rating : 200,000A rms symmetrical, 600 volts (when used with specified AC input line fuses as detailed in Table 2-C).
- Ride Through: 2 seconds minimum
- Efficiency: 90% typical

Feedback Devices

- Encoder: Incremental, dual channel; 12 volts, 500mA, isolated with differential transmitter, 102.5 KHz max. Quadrature: $90^\circ \pm 27^\circ$ @ 25°C, Duty Cycle: 50% + 10%, A-B 845H or equal.

Installation/Wiring

Chapter Objectives

Chapter 2 provides the information needed to properly mount and wire the 1336 FORCE Drive. Since most start-up difficulties are the result of incorrect wiring, every precaution must be taken to assure that the wiring is completed as instructed. All items must be read and understood before the actual installation begins.

IMPORTANT: The end user is responsible for completing the installation, wiring and grounding of the 1336 FORCE drive and for complying with all National and Local Electrical Codes.



ATTENTION: The following information is merely a guide for proper installation. The National Electrical Code and any other governing regional or local code will overrule this information. The Allen-Bradley Company **cannot** assume responsibility for the compliance or the noncompliance to any code, national, local or otherwise for the proper installation of this drive or associated equipment. A hazard of personal injury and/or equipment damage exists if codes are ignored during installation.

Mounting

The 1336 FORCE drive is delivered in a NEMA Type 1 enclosure that must be mounted so that there is sufficient space at the top, sides and front of the cabinet to allow for heat dissipation as shown in Figure 2.1.

Figure 2.1.
Mounting Requirements

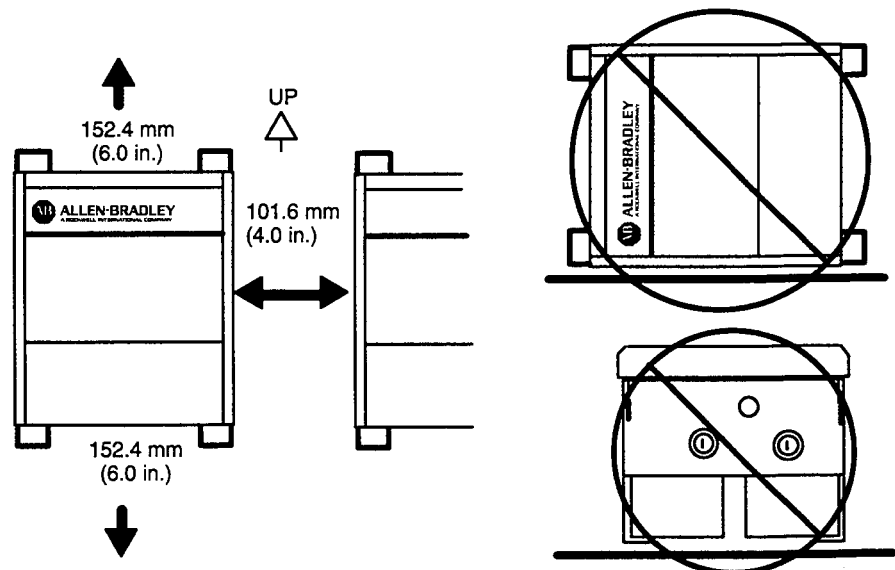
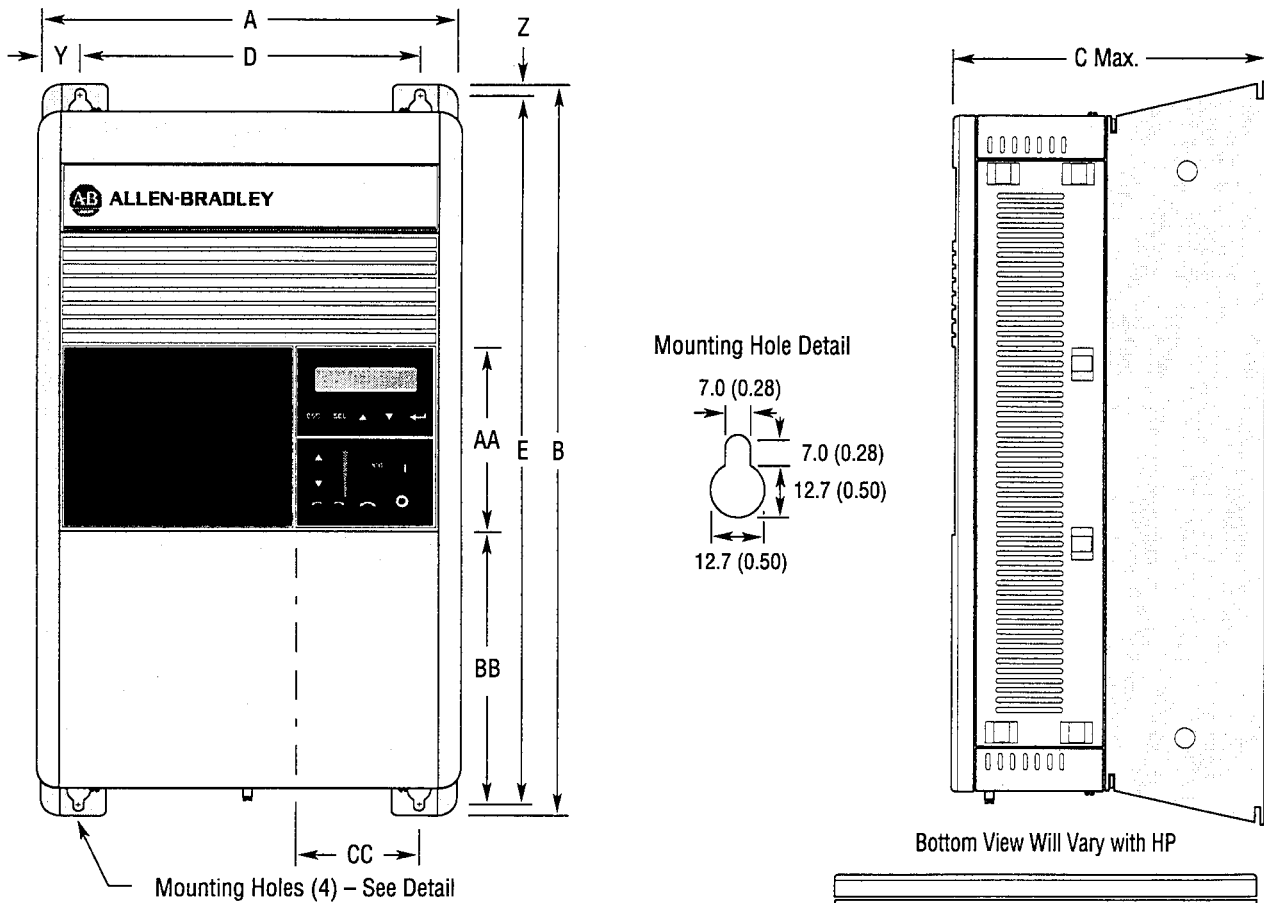
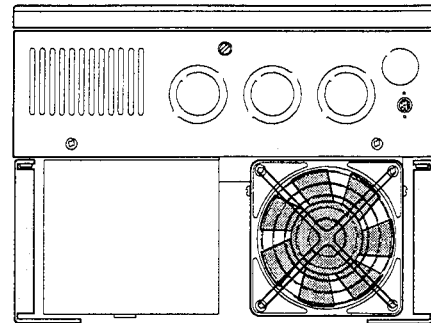

Figure 2.2.
IP20 (NEMA Type 1) Dimensions – Frames B,C,D



Drive Output Rating			Frame Ref.
200 Thru 240	380 Thru 480	500 Thru 600	
7.5 - 15HP 11 - 19kW	7.5 - 30HP 11 - 38kW	7.5 - 20HP 10 - 24kW	B
20 - 30HP 26 - 32kW	40 - 60HP 47 - 61kW	25 - 60HP 30 - 62kW	C
40 - 60HP 48 - 72kW	60 - 150HP 76 - 143kW	75 - 125HP 85 - 137kW	D
75 - 100HP 96 - 129kW	150 - 250HP 191 - 259kW	150 - 250HP 157 - 283kW	E
	300 - 500HP 349 - 534kW	300 - 600HP 344 - 667kW	F



All Dimensions in Millimeters and (Inches)
All Weights in Kilograms and (Pounds)

Frame ^{1,2} Reference	A	B	C Max.	D	E	Y	Z	AA	BB	CC	Knockouts 3-Dual Size, 1-Fixed	Shipping Weight
B	276.4 (10.88)	476.3 (18.75)	225.0 (8.86)	212.6 (8.37)	461.0 (18.15)	32.00 (1.26)	7.6 (0.30)	131.1 (5.16)	180.8 (7.12)	71.9 (2.83)	28.6/34.9, 22.2 (1.125/1.375, 0.875)	22.7 kg (50 lbs.)
C	301.8 (11.88)	701.0 (27.60)	225.0 (8.86)	238.0 (9.37)	685.8 (27.00)	32.00 (1.26)	7.6 (0.30)	131.1 (5.16)	374.7 (14.75)	71.9 (2.83)	28.6/34.9, 22.2 (1.125/1.375, 0.875)	38.6 kg (85 lbs.)
D	381.5 (15.02)	1240.0 (48.82)	270.8 (10.66)	325.9 (12.83)	1216.2 (47.88)	27.94 (1.10)	11.94 (0.47)	131.1 (5.16)	³	71.9 (2.83)	³	108.9 kg (240 lbs.)

² kW/HP are constant torque (CT) ratings. ³ Not available at time of publication

NOTE: Frame sizes A1,A2 and A3 are Not available in the FORCE product

Figure 2.3.
IP 20 (NEMA Type 1) Dimensions – Frame E

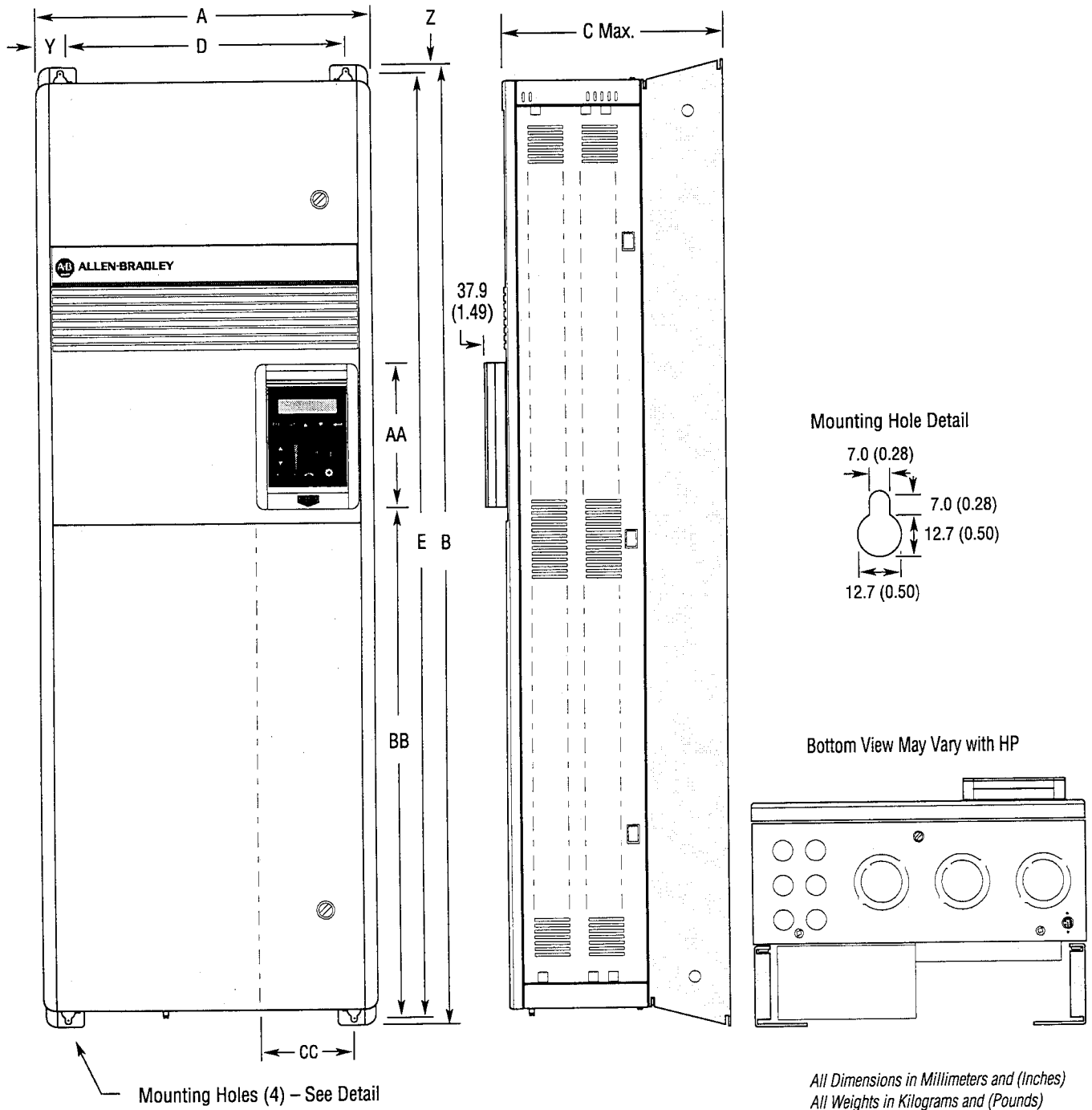

Frame ^{1,2}	A	B	C Max.	D	E	Y	Z	AA	BB	CC	Knockouts 3-Dual Size, 1-Fixed	Shipping Weight
Reference												
E	511.0 (20.12)	1498.6 (59.00)	424.4 (16.71)	477.5 (18.80)	1447.8 (57.00)	16.8 (0.66)	40.1 (1.61)	3	860.6 (33.88)	3	3	186 kg (410 lbs.)

² kW/HP are constant torque (CT ratings)

³ Not available at time of publication

Figure 2.4.
IP 20 (NEMA Type 1) Dimensions – Frame F

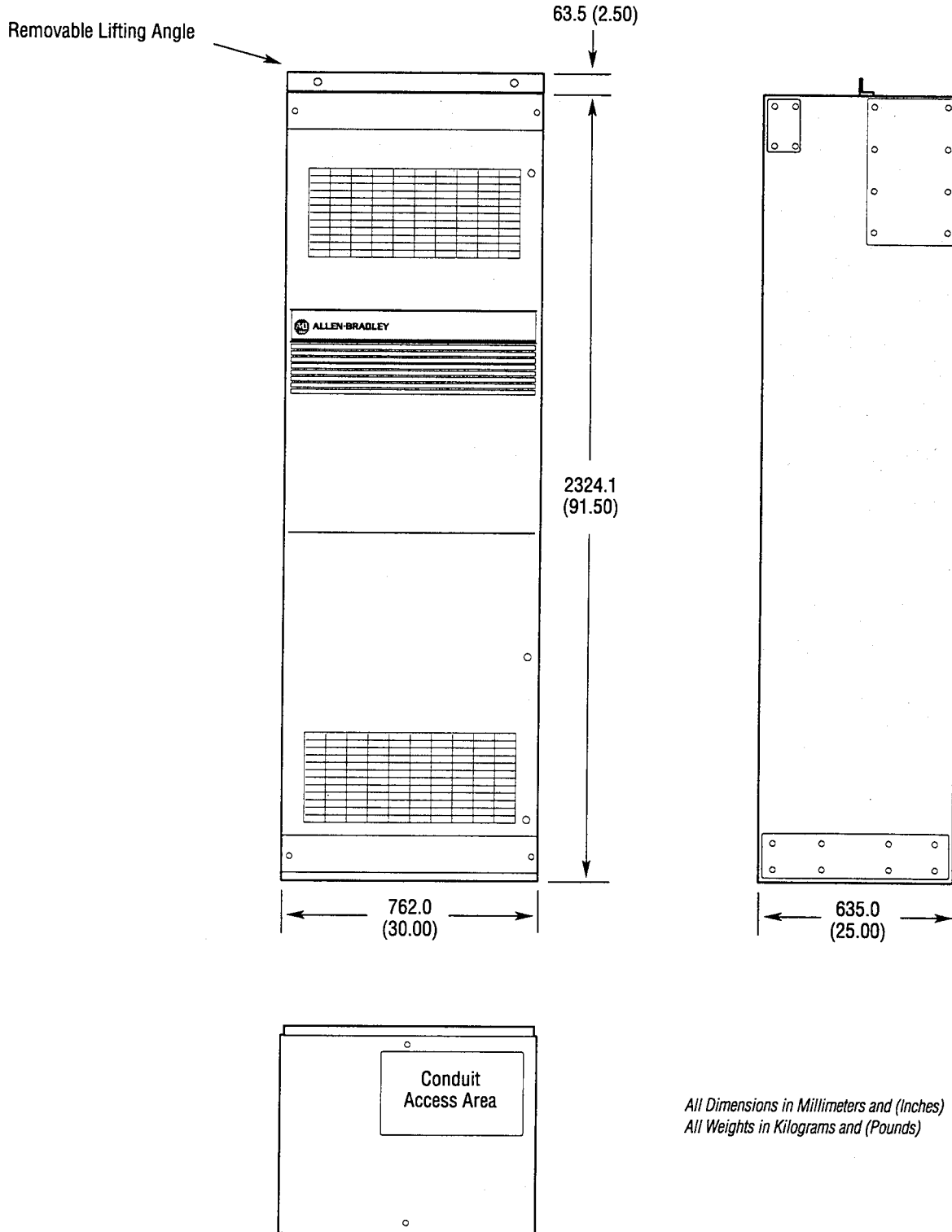

All Dimensions in Millimeters and (Inches)
All Weights in Kilograms and (Pounds)

Input Power Conditioning

Typically the 1336 FORCE is suitable for direct connection to a correct voltage, three-phase, AC power line. There are however certain power line conditions which may introduce the possibility of drive input power component malfunction. To reduce the possibility of these malfunctions, a line reactor or isolation type transformer may be required.

The basic rules for determining if a line reactor or isolation type transformer is required are as follows:

1. If the AC line supplying the drive has power factor correction capacitors connected, an AC line reactor or isolation transformer must be connected between the capacitor bank and the input to the drive.
2. If the AC line experiences transient power interruptions or significant voltage spikes, an AC line reactor or isolation type transformer should be used.
3. If the AC input power system does not have the neutral or one phase referenced to ground (i.e. it is an ungrounded system), an isolation transformer with the neutral of the secondary grounded is highly recommended. If the line to ground voltage on any phase can exceed 125% of the normal line to line voltage, an isolation transformer with the neutral of the secondary grounded is **always** required.
4. A line reactor or Isolation transformer may be required if the AC Drive shares the same line as a line commutated SCR converter or a line commutated DC Drive.

AC Supply Source

11–667 kW (7.5–500HP) drives are suitable for use on a circuit capable of delivering up to a maximum of 200,000 rms symmetrical amperes, 600 volts maximum when used with the AC input line fuses specified in Table 2.C. The 1336 FORCE does not contain input power short circuit fusing. Specifications for the recommended size and type to provide drive input power protection against short circuits are on the following pages.



ATTENTION: To guard against personal injury and/or equipment damage caused by improper fusing, use only the recommended line fuses specified in Table 2.A. Branch circuit breakers or disconnect switches cannot provide this level of protection for drive components.

Power Wiring

Input and output power connections are performed through terminal block TB1 on the Base Driver Board for Frame Size B drives. For frame sizes C,D,E and F, there are terminal blocks located on the bottom of the drive where both the input and output power connections are to be made.

Grounding Procedures

The purpose of grounding is to:

- Limit dangerous voltages on exposed parts to ground potential in the event of an electrical fault.
- To facilitate proper overcurrent device operation when ground fault conditions are incurred.
- To provide for electrical interference suppression. Improper grounding could lead to electrical noise problems, which could result in unstable drive operation.

The general grounding concept for the 1336 FORCE is shown in Figure 2.5 and explained below.

Safety Ground (PE) – Is the safety ground required by most codes. The ground bus can be connected to adjacent building steel (girder, joist) or a floor ground grid, provided grounding points comply with NEC regulations and Local Codes.

IMPORTANT: Multiple connections are permitted, but Do Not ground (PE) and signal (TE) grounds together at the drive.

The minimum distance between Signal (TE) and Safety Ground (PE) is 10 feet (3 meters). The safety ground bus requires a maximum of 1 ohm resistance to ground.

Power Feeder – Each power feeder from the substation transformer to the drive must be provided with properly sized ground cables. Simply utilizing the conduit or cable armor as a ground is not adequate. The conduit or cable armor and ground wires should be bonded to substation ground at both ends. Each transformer enclosure and/or frame must be bonded to ground at a minimum of two locations.

Motor Connection – Each AC motor frame must be bonded to grounded building steel within 20 feet (6 meters) of its location and tied to the Drive PE via ground wires within the power cables and/or conduit. Bond the conduit or cable armor to ground at both ends. The PE ground wire size on the 1336 FORCE must be the same size as the motor conductors.

Signal Ground (TE) – Must be connected to an earth ground by a insulated continuous separate lead .

The PLC®I/O Communication Link must be run in separate grounded steel conduit. The conduit should be bonded to ground at both ends. Ground the cable shield at the drive end only.

Encoder Connections – Must be routed in grounded steel conduit. The conduit must be grounded at both ends. Ground the cable shield at the Drive end only.

IMPORTANT: The Encoder Cable Shield must NOT be grounded at the Encoder end.

Figure 2.5.
1336 FORCE Grounding Practices

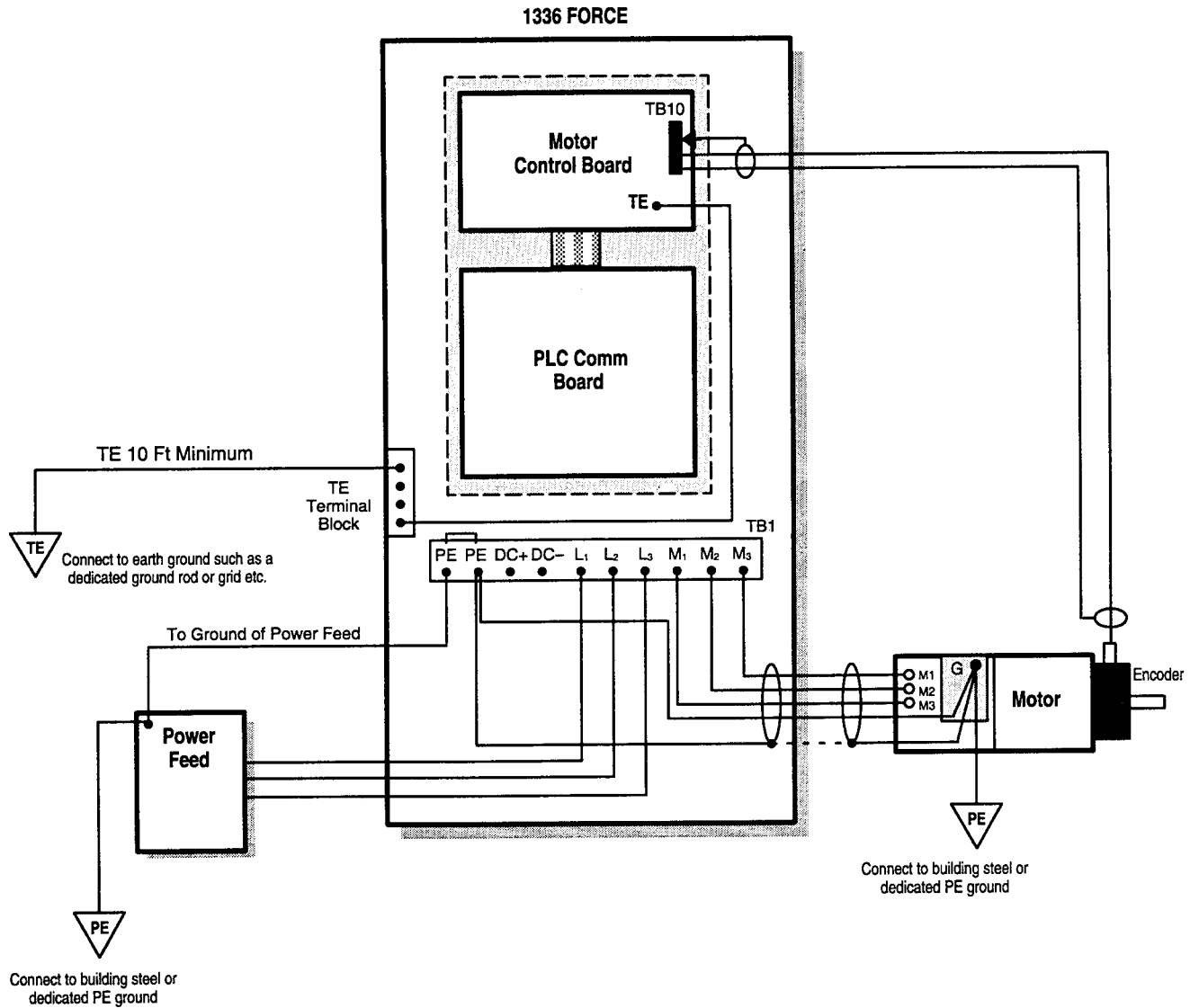

IMPORTANT:

1. Connect encoder shield at Drive, NOT at encoder.
2. Ground cable from Inverter P.E. must be connected at Drive and Motor.
3. Ground wire from drive to motor must run inside a shield.
4. Shielded motor leads are preferred.
5. The motor cable shield must be grounded at the Drive and the motor.



Signal Ground



Power Safety Ground

Wire Size and Type

Wire sizes must be selected individually, observing all applicable safety and NEC and local regulations. Due to the drive overload capacity, the conductors for the transformer primary and secondary must be sized (at a minimum) for 125% of the maximum motor current. The motor conductors must also be rated for 125% of the full load motor current. The distance between the drive and motor may affect the size of the conductors used.

Shielded type wire is recommended in control circuits for protection against interference. A shielded wire is required for all signal wires. The recommended conductor size must be a minimum of 16 AWG. The best interference suppression is obtained with a wire having an individual shield for every twisted pair. Table 2–A provides a listing and description of cable types and wiring recommendations. Figure 2.6 shows recommended cable shielding.

Figure 2.6.
Cable Shielding Recommendations

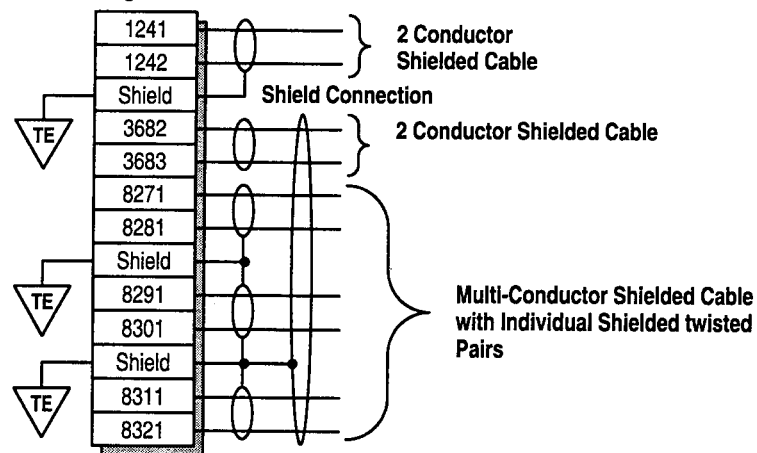

ATTENTION: The National Electrical Code (NEC) and local codes outline provisions for safely installing electrical equipment. Installation must comply with specifications regarding wire types, conductor sizes, branch circuit protection and disconnect devices. Failure to do so may result in personal injury and/or equipment damage.

Table 2-A.
Cable and Wiring Recommendations

Category	Wiring Class	Signal Definition	Signal Examples	Cable Type	Minimum Spacing in Inches between Classes – Steel Conduit/Tray					Spacing Notes
					1	2/3/4	5/6	7/8	9/10/11	
Power	1	AC Power (600V or greater)	2.3kV 3/Ph AC Lines	per NEC & Local Codes	0	3/9	3/9	3/18	Note 6	1/2/5
	2	AC Power (less than 600V)	460V 3/Ph AC Lines	per NEC & Local Codes	3/9	0	3/6	3/12	Note 6	1/2/5
	3	DC Power	Reg. DC Motor Field	per NEC & Local Codes						
	4	DC Power	DC Motor Armature	per NEC & Local Codes						
Control	5	115V AC/DC Logic	Relay Logic/PLC I/O Motor Thermostat	per NEC & Local Codes	3/9	3/6	0	3/9	Note 6	1/2/5
		115V AC Power	Power Supplies, Instruments							
	6	24V AC/DC Logic	PLC I/O	per NEC & Local Codes						
Signal (Process)	7	Analog Signals, DC Supplies	Reference/Feedback Signal, 5 to 24V DC	Shielded Cable – Belden 8735, 8737, 8404	3/18	3/12	3/9	0	1/3	2/3/4/5
		Digital (low speed)	TTL							
8	Digital (high speed)	I/O, Encoder, Counter Pulse Tach	Shielded Cable – Belden 9728, 9730							
Signal (Comm)	9	Serial Communication	RS-232, 422 to Terminals/Printers	Shielded Cable – Belden RS-232 – 8735, 8737 RS-422 – 9729, 9730	Note 6			1/3	0	
	11	Serial Communication (greater than 20k baud)	PLC Remote I/O, PLC Data Highway							

Example: Spacing relationship between 480V AC incoming power leads and 24V DC logic leads.

- 480V AC leads are Class 2 ; 24V DC leads are Class 6
- For separate steel conduits, the conduits must be 3 inches (76 mm) apart
- In a cable tray, the two groups of leads are to be 6 inches (152 mm) apart

Spacing Notes:

1. Both outgoing and return current carrying conductors are to be pulled in same conduit or laid adjacent in tray.
2. Cables of the following classes can be grouped together.
 - A. Class 1; Equal to or above 601 volts
 - B. Classes 2,3, and 4 may have their respective circuits pulled in the same conduit or layered in the same tray.
 - C. Classes 5 and 6 may have their respective circuits pulled in the same conduit or layered in the same tray.
Note: Bundle may not exceed conditions of NEC 310
 - D. Classes 7 and 8 may have their respective circuits pulled in the same conduit or layered in the same tray.
Note: Encoder cables run in a bundle may experience some amount of EMI coupling. The circuit application may dictate separate spacing.
 - E. Classes 9, 10 and 11 may have their respective circuits pulled in the same conduit or layered in the same tray.
Communication cables run in a bundle may experience some amount of EMI coupling and corresponding communication faults. The application may dictate separate spacing.
3. All wires of class 7 thru 11 MUST be shielded per the recommendations
4. In cable trays, steel separators are advisable between the class groupings.
5. If conduit is used, it must be continuous and composed of magnetic steel

6. Spacing of communication cables classes 2 thru 6 is:

CONDUIT SPACING	THRU AIR
115 Volts – 1 inch	115 Volts – 2 inches
230 Volts – 1.5 inches	230 Volts – 4 inches
460/575 Volts – 3 inches	460/575 Volts – 8 inches
575 volts – proportional to 6" per 1000 volts.	575 volts proportional to 12" per 1000 volts

General Notes

1. Steel conduit is recommended for all wiring classes. (Classes 7-11).
2. Spacing shown between classes is the minimum required for parallel runs less than 400 feet. Greater spacing should be used where possible.
3. Shields for shielded cables must be connected at one end only. The other end should be cut back and insulated. Shields for cables from a cabinet to an external device must be connected at cabinet end. Shields for cables from one cabinet to another must be connected at the source end cabinet. Splicing of shielded cables, if absolutely necessary, should be done so that shields remain continuous and insulated from ground.
4. Power wire is selected by load. 16AWG is the minimum recommended size for control wiring.

Lug Kits

The Lug Kits that must be used with the 1336 FORCE drive are detailed in Table 2-B. For proper installation of Lug Kits refer to the respective Lug Kit instruction sheet.

Table 2-B.
Recommended Lug Kits

Nominal HP	Input Voltage AC Line VAC	Used With Standalone Drive Catalog No.	Used With Common Bus Drive Catalog No.	Lug Kit Catalog No.
75	200 – 240	1336S/T – A75A	1336S/T – Q75A	1336-LUG-AQ75
100	200 – 240	1336S/T – A100A	1336S/T – Q100A	1336-LUG-AQ100
125	380 – 480	1336S/T – BX150A	1336S/T – RX150A	1336-LUG-BRX150
150	380 – 480	1336S/T – B150A	1336S/T – R150A	1336-LUG-BR150
200	380 – 480	1336S/T – B200A	1336S/T – R200A	1336-LUG-BR200
250	380 – 480	1336S/T – B250A	1336S/T – R250A	1336-LUG-BR250
300	380 – 480	1336S/T – B300A	1336S/T – R300A	1336-LUG-BR300
350	380 – 480	1336S/T – B350A	1336S/T – R350A	1336-LUG-BR350
400	380 – 480	1336S/T – B400A	1336S/T – R400A	1336-LUG-BR400
450	380 – 480	1336S/T – B450A	1336S/T – R450A	1336-LUG-BR450
500	380 – 480	1336S/T – B500A	1336S/T – R500A	1336-LUG-BR500
150	500 – 600	1336S/T – C150A	1336S/T – C150A	1336-LUG-CW150
200	500 – 600	1336S/T – C200A	1336S/T – C200A	1336-LUG-CW200
250	500 – 600	1336S/T – C250A	1336S/T – C250A	1336-LUG-CW250
300	500 – 600	1336S/T – C300A	1336S/T – C300A	1336-LUG-CW300
350	500 – 600	1336S/T – C350A	1336S/T – C350A	1336-LUG-CW350
400	500 – 600	1336S/T – C400A	1336S/T – C400A	1336-LUG-CW400
500	500 – 600	1336S/T – C500A	1336S/T – C500A	1336-LUG-CW500



ATTENTION: Hazard of fire or equipment damage exist from overheated connections. Lug kits are specifically designed for use with ratings listed. Use lug kits to avoid hazards and maintain UL certification.

AC Input Line Fuses

The input fuses are supplied by the user and must be UL Class CC, T, J (7.5–250 HP), Type SPP, FWP or A70Q (300–500HP) or equivalent. The recommended fuse types are detailed in Table 2–C.

Table 2–C.
Maximum Recommended AC Line Fuse Ratings
(User supplied, fast acting or slow blow)

Drive Catalog No.	HP Rating	230V Rating	460V Rating	575V Rating
1336T–xx007	7.5	40A	20A	15A
1336T–xx010	10	60A	30A	20A
1336T–xx015	15	70A	35A	25A
1336T–xx020	20	90A	45A	35A
1336T–xx025	25	120A	60A	40A
1336T–xx030	30	140A	70A	50A
1336T–xx040	40	150A	90A	60A
1336T–xx050	50	200A	100A	80A
1336T–xx060	60	250A	125A	90A
1336T–xx075	75	300A	150A	110A
1336T–xx100	100	400A	200A	150A
1336T–xx125	125	500A	250A	175A
1336T–xx150	150	600A	300A	225A
1336T–xx200	200		400A	350A
1336T–xx250	250		450A	400A
1336T–xx300	300		450A	400A
1336T–xx350	350		500A	450A
1336T–xx400	400		600A	500A
1336T–xx450	450		800A	600A
1336T–xx500	500		800A	800A

Drive Output Disconnection

IMPORTANT: Any disconnecting means wired to Drive output terminals M1, M2 and M3 must be capable of disabling the Drive if opened during Drive operation. If opened during Drive operation, the Drive will fault. It is recommended that the Drive Enable be removed before the contactor is opened. When the Drive Enable is removed, the Drive will stop modulating.

Control Wiring



ATTENTION: When user installed control and signal wiring with an insulation rating of less than 600V is used, this wiring must be routed inside the drive enclosure so that it is separated from any other wiring and uninsulated live parts. Failure to do so could result in equipment damage or unsatisfactory Drive performance.

Encoder, Brake and Control Area Network connections are performed on the Motor Control Board (Fig. 2.7). The maximum and minimum wire size accepted by TB10 and TB11 on the Motor Control Board is 3.3 and 0.06 mm² (12 and 30 AWG). Maximum torque for both terminal blocks is 0.79 N-m (7 lb-in.). Use copper wire only.

Figure 2.7.
Terminal Block Locations Motor Control Board

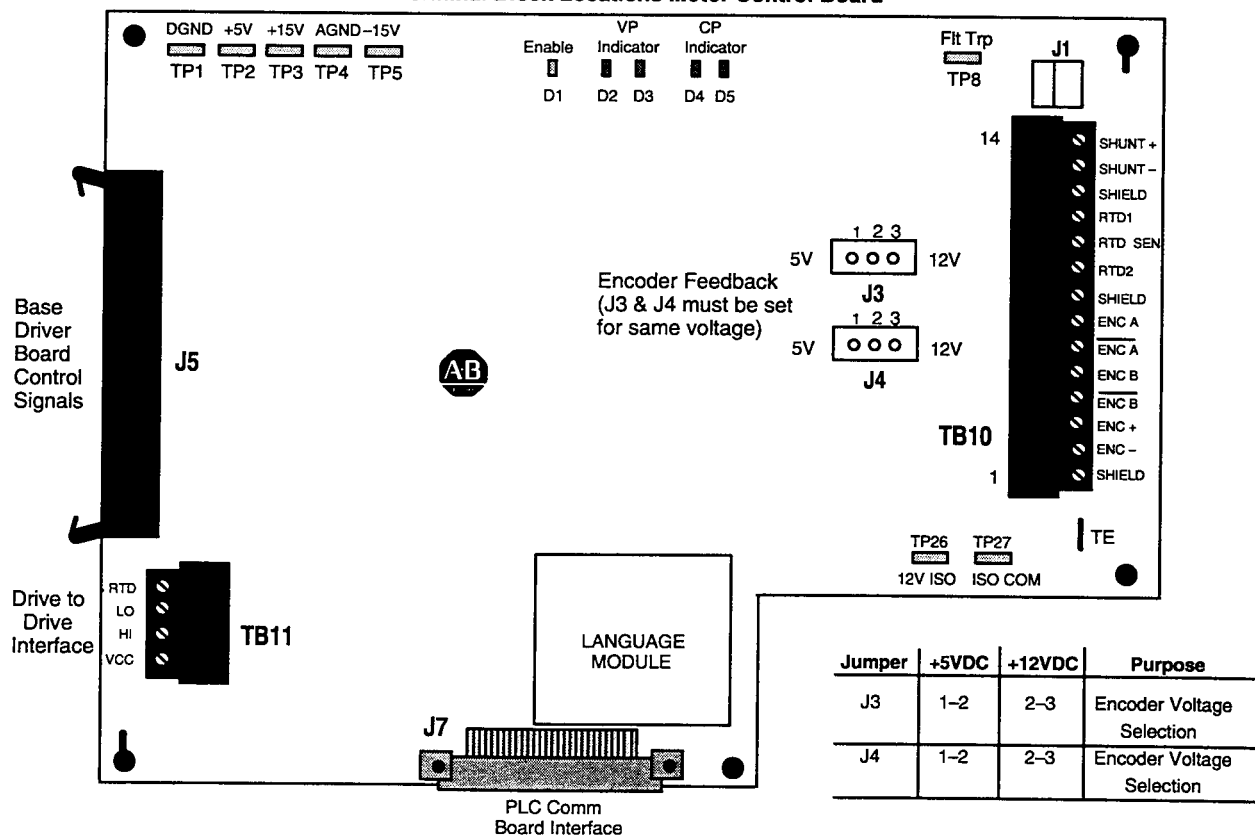

D1	Green	Drive Enable	ON – Drive Running, OFF – Drive Not Running
D2	Green	VP Indicator	ON – No Faults, OFF – See D3
D3	Red	VP Indicator	Refer to Fault Codes in Table 4.A
D4	Green	CP Indicator	ON – No Faults, OFF – See D5
D5	Red	CP Indicator	Refer to Fault Codes in Table 4.A

Encoder Connections

The Encoder connections are made at terminal block TB10 on the Motor Control Board as detailed in Figure 2.8.

Figure 2.8.
Encoder Connections

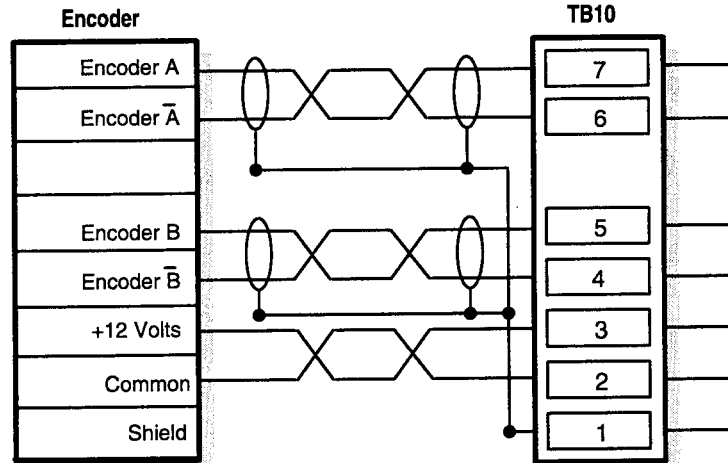

Brake Control Connections

The TB10 connector on the Motor Control Board (Figure 2.9) can be used to connect an optional Dynamic brake circuit.

Figure 2.9.
Dynamic Brake Control Circuit Connections
(Currently for Allen-Bradley Development use only).

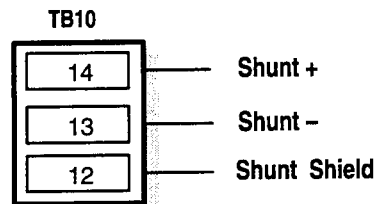

IMPORTANT: If you are using an Allen-Bradley brand brake this connection would not be used, as Allen-Bradley brakes are self monitoring.

Drive to Drive Communication
(CAN Connections)

The TB11 connector on the Motor Control Board (Figure 2.10) is used to connect the Control Area Network.

Figure 2.10.
CAN Connections

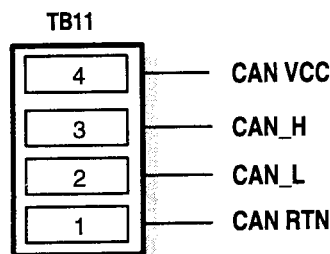

Power Wiring

On 7.5 to 30 HP drives, input and output power connections are performed through a 10 position terminal block, TB1 located on the Gate Driver Board (see Figure 2.12 for location). On drives larger than 30 HP, input and output power connections are made at separate terminal strips located at the bottom of the drive. The 40 to 200 HP drive connections are illustrated in Figure 2.11. These configurations of TB1 are stud terminations and require the use of lug type connectors to terminate the field installed conductors. Cat. No. 1336-LUG-XXXX Lug Kits are available for use with these configurations of TB1. The wire size used is determined by selecting the proper lug kit based on the Cat. No. of the drive. Refer to Table 2.B to determine the correct lug kit for your application.

Figure 2.11.
Terminal Block TB1

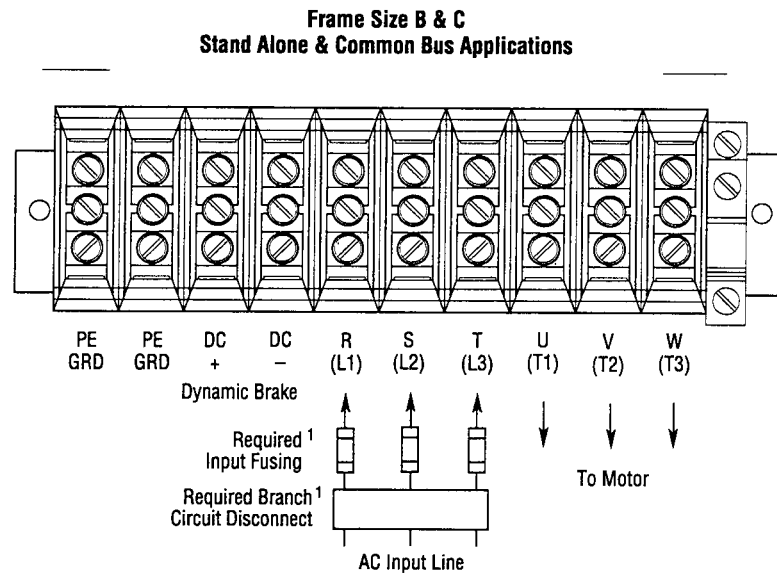
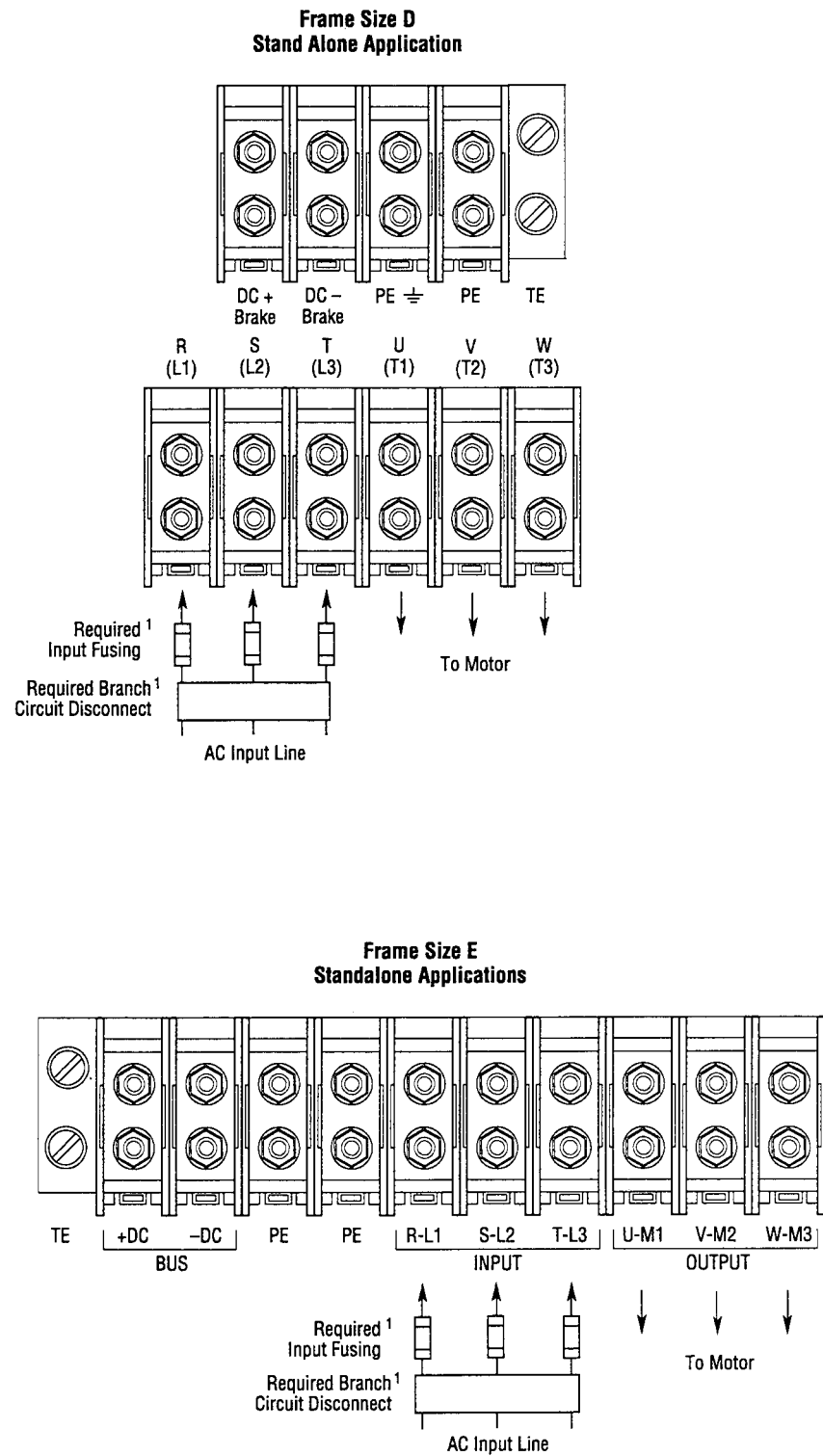
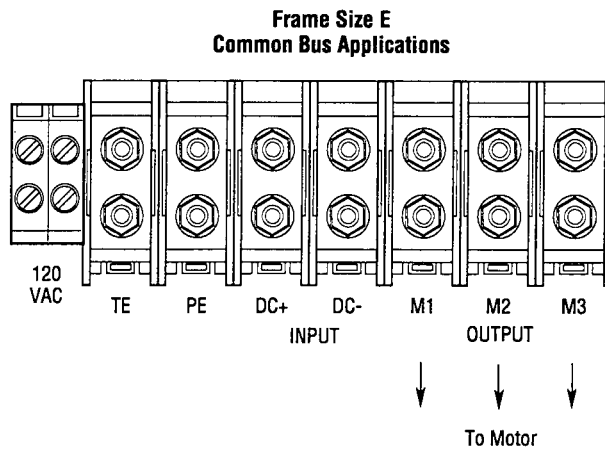
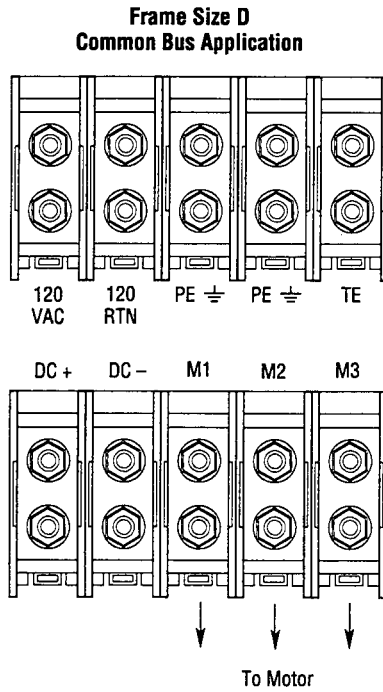

Figure 2.11. cont.
Terminal Block TB1



¹ User supplied.

Figure 2.11. cont.
Terminal Block TB1



¹ User supplied.

Figure 2.11. cont.
Terminal Block TB1

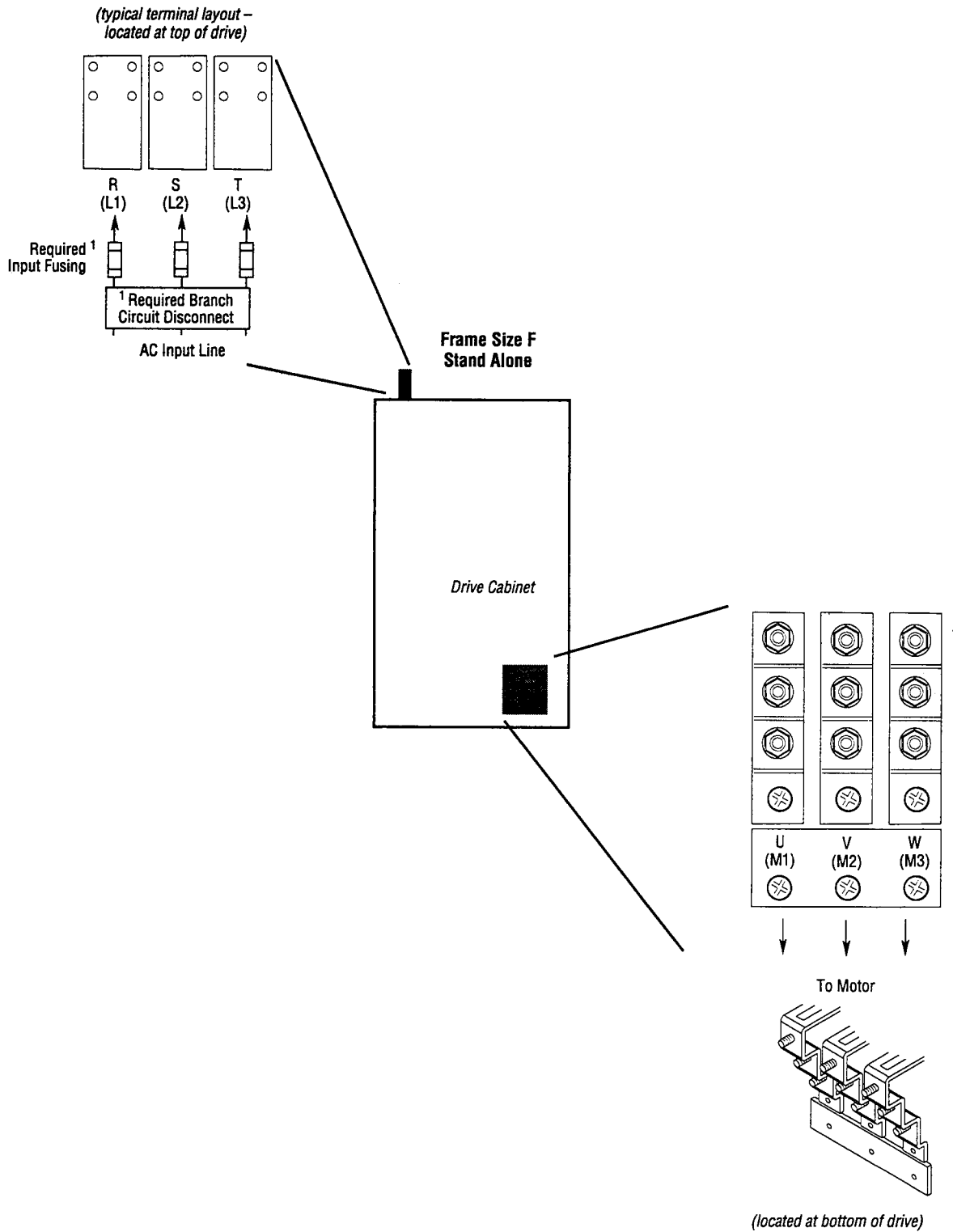
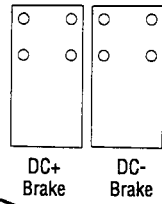
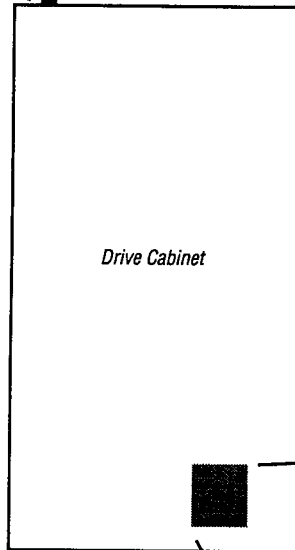

Figure 2.11. cont.
Terminal Block TB1

*(typical terminal layout –
located at top of drive)*



Frame Size F
Common Bus



Drive Cabinet

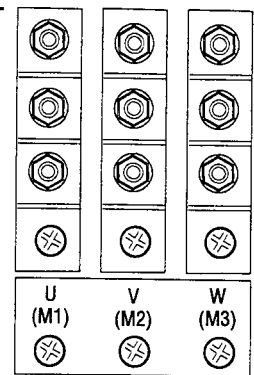

To Motor

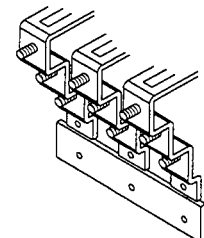

(located at bottom of drive)

Figure 2.12.
Frame Size B Gate Driver Board Connections

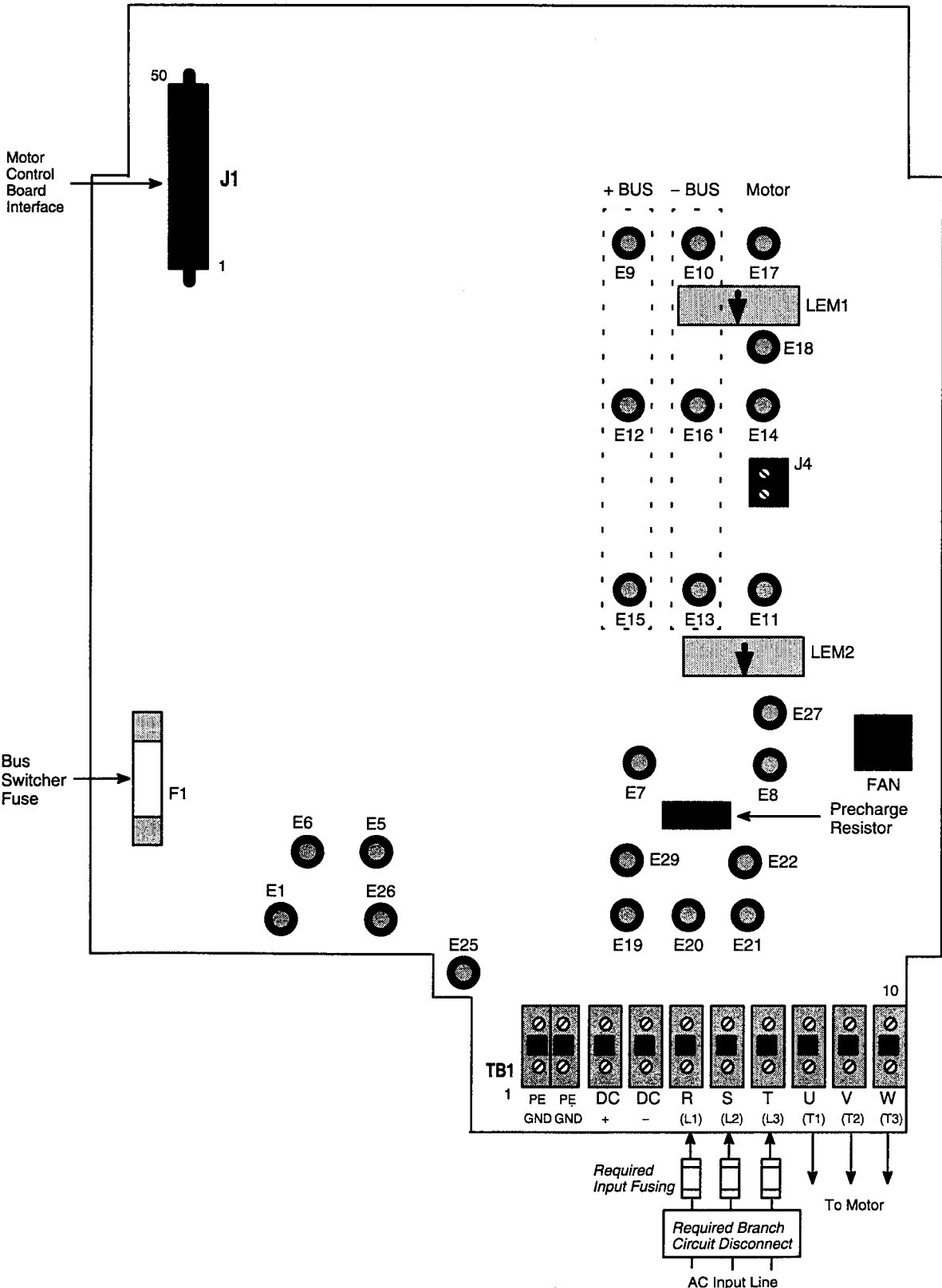

Figure 2.13.
Frame Size C Gate Driver Board Connections

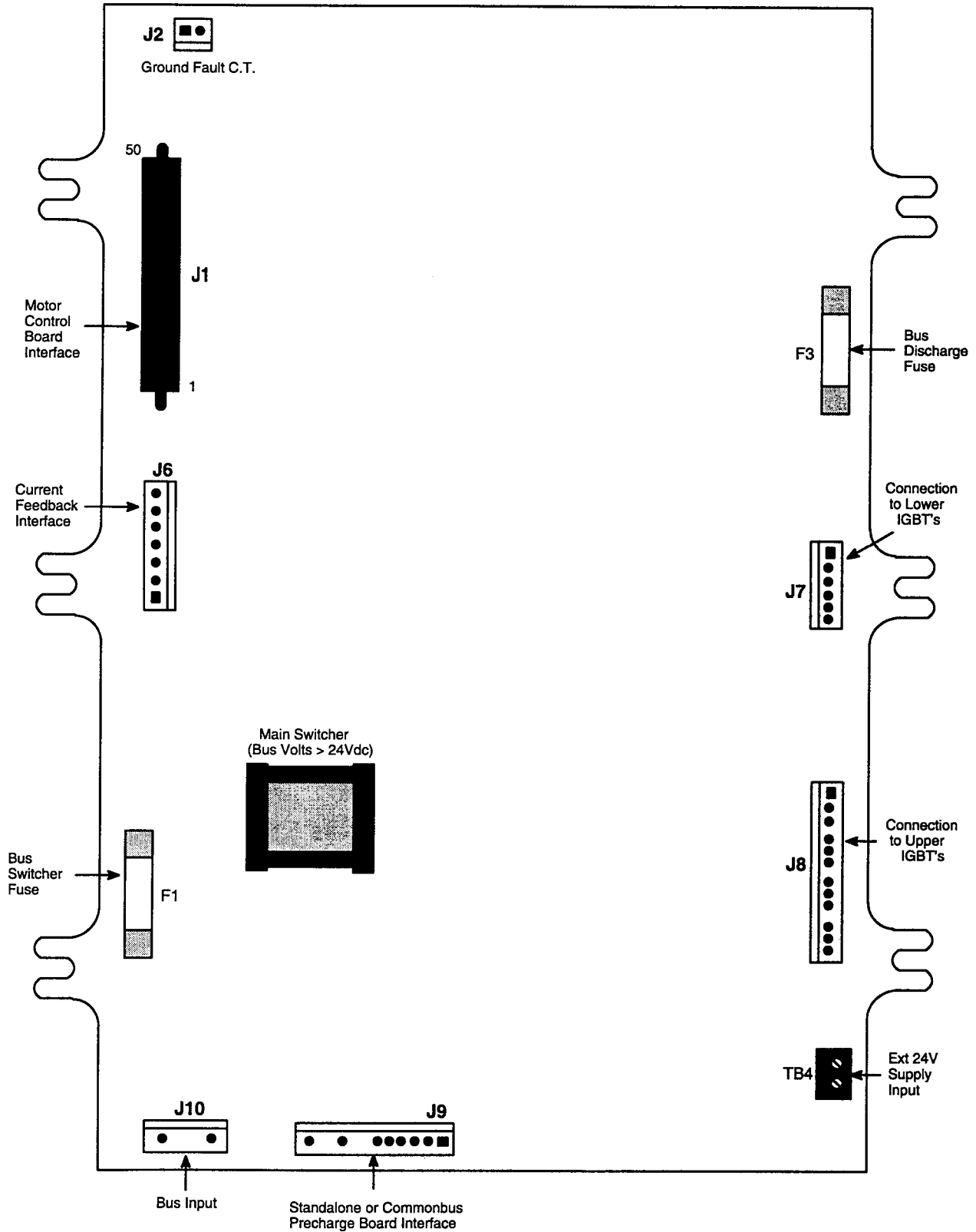
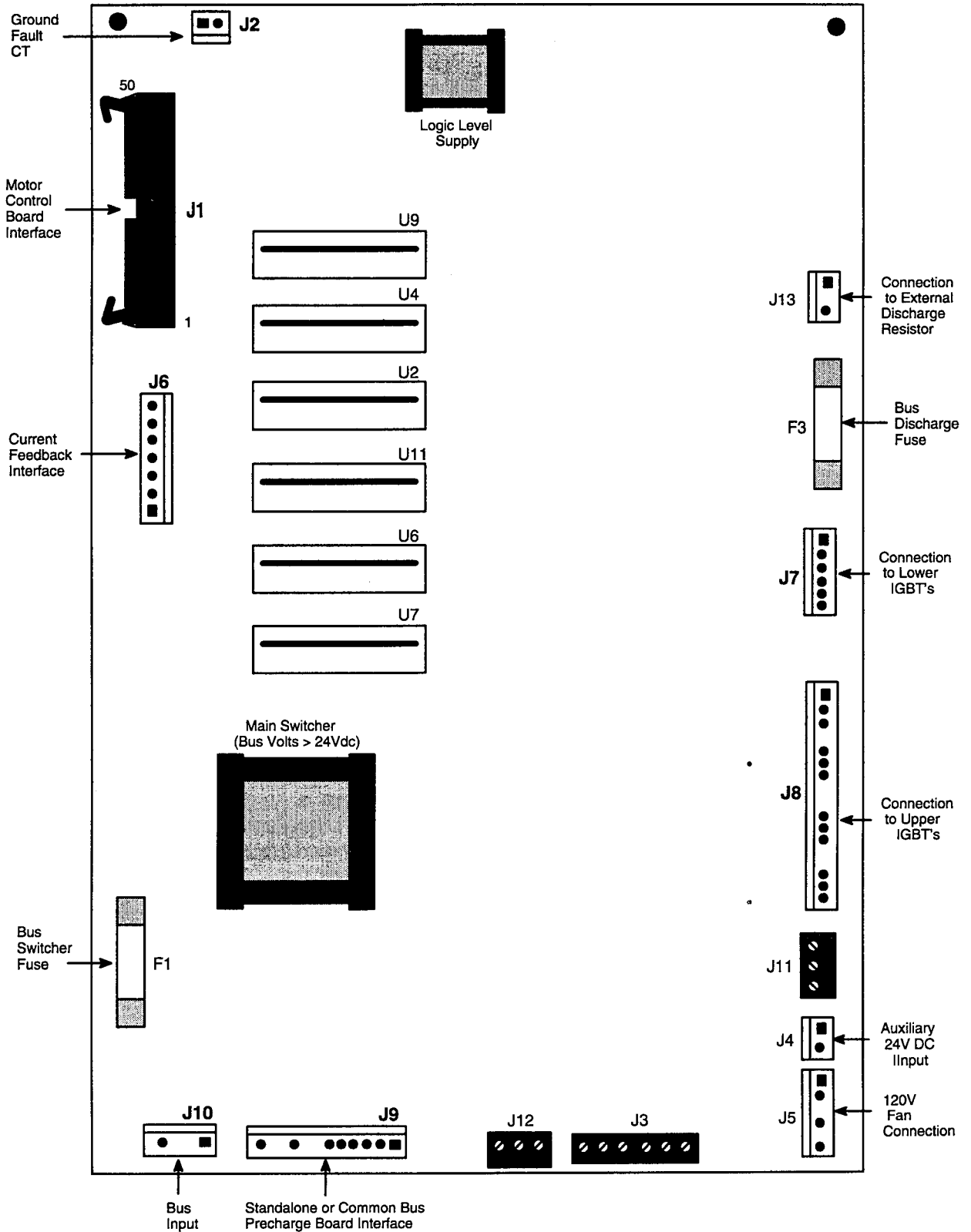

Figure 2.14.
Frame Size D, E&F Gate Driver Board Connections



Control & Signal Wiring

If your 1336 FORCE Drive is equipped with a PLC Comm Adapter Board, terminal blocks TB20 & TB21 located at the bottom center of the PLC Comm Board (Figure 2.16) are used for control and signal wiring (Drive Permissives). Connector TB21 provides the interface for Analog Input and Output reference signals as detailed in Figure 2.15. The maximum and minimum wire size accepted by TB20, TB21, Channel A and Channel B is 3.3 and 0.06 mm² (12 and 30 AWG). Maximum torque for these terminal blocks is 0.79 N-m (7 lb. – in.). Only copper wire may be used.

Figure 2.15.
Reference Signal Connections

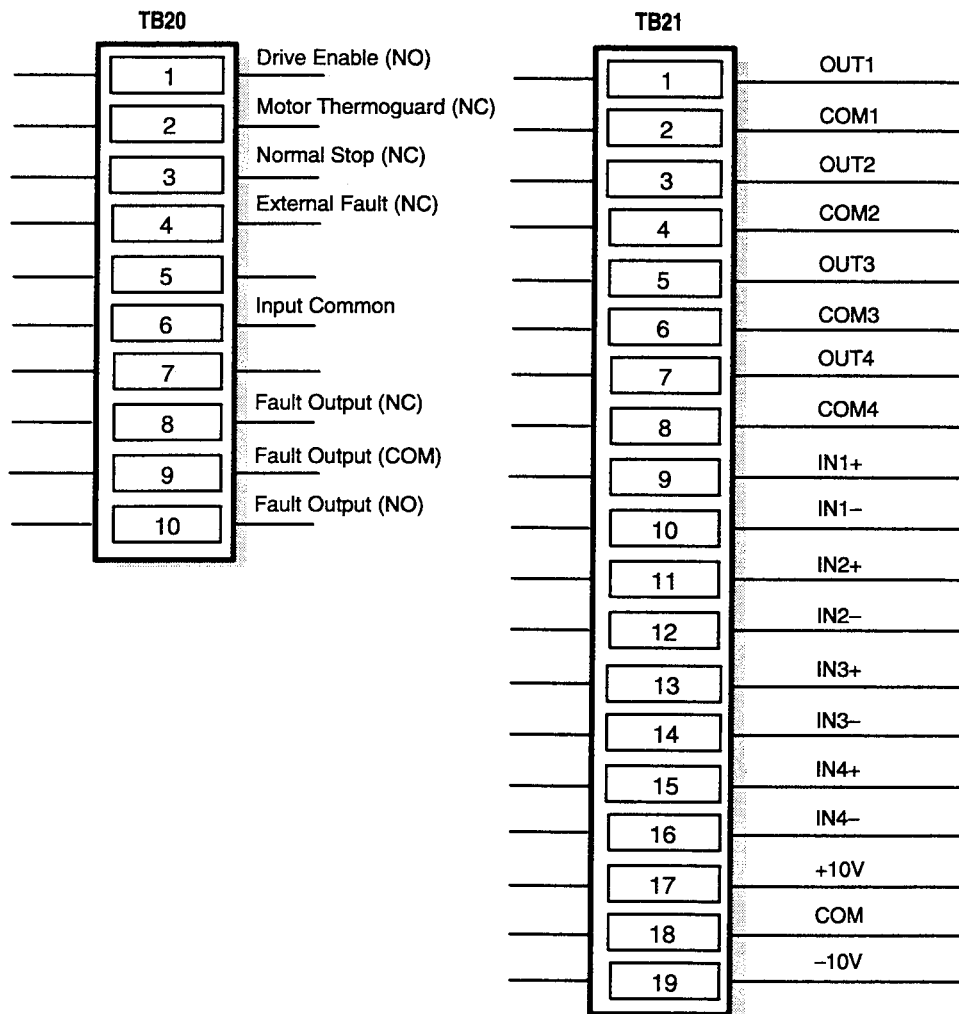

Pin jumper J3 on the PLC Comm Board Enables or Disables the BRAM Write function as follows:

- Jumpered 1 – 2 = Enabled
- Jumpered 2 – 3 = Disabled

The PLC Comm Board 120V/24V jumper settings for I/O circuits (J8 – J11) are detailed in the 1336 FORCE PLC Communications Adapter User Manual 1336 FORCE – 5.7.

Figure 2.16.
PLC Comm Board Connections

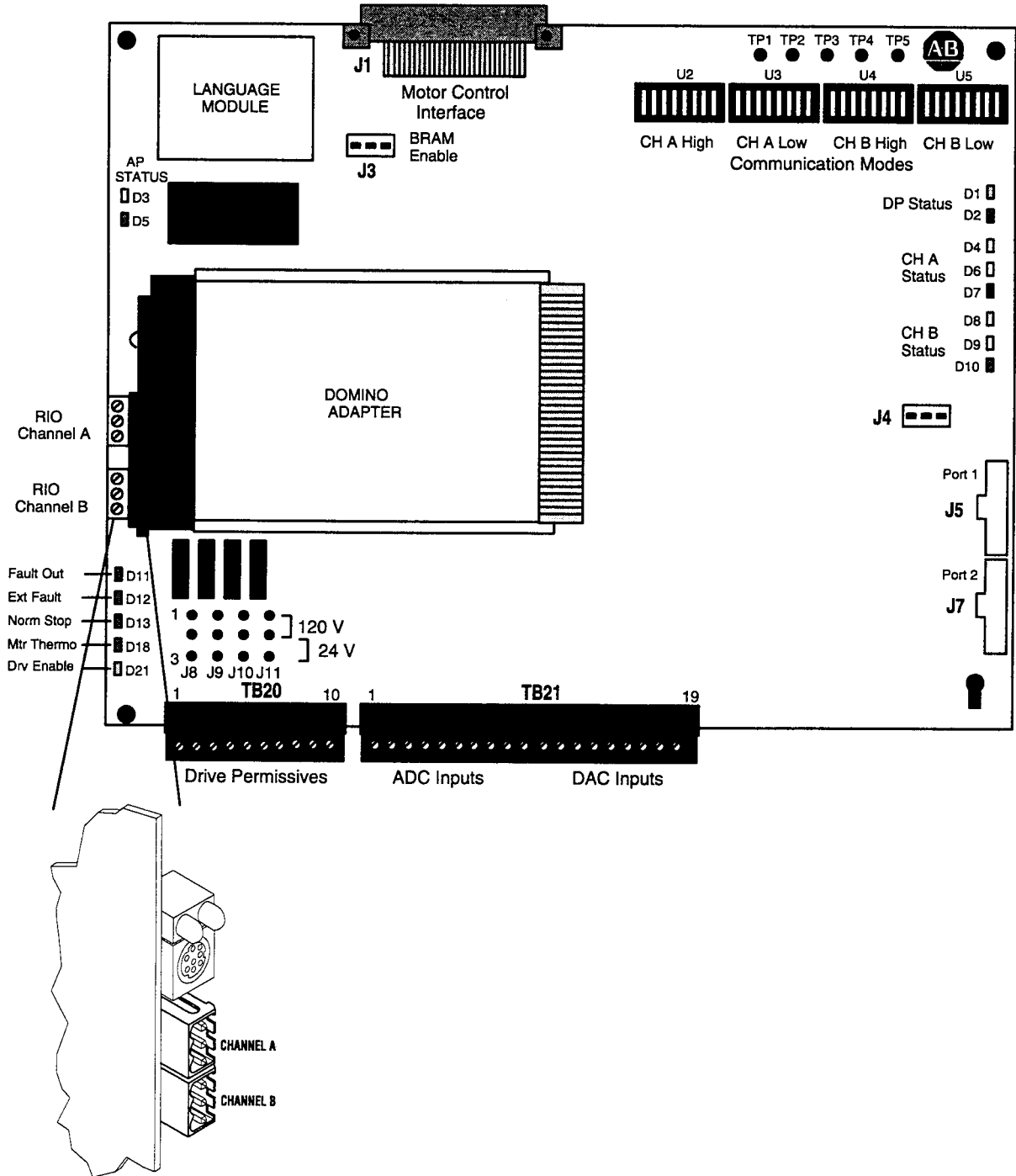

Switch Settings

There are DIP switches & jumpers located on the PLC Communications Board that have been preset at the factory. If there becomes a need to reconfigure the switches or jumpers the 1336 FORCE PLC Communications Adapter User Manual should be consulted.

Starting & Stopping the Motor



ATTENTION: The 1336 FORCE Drive control circuitry includes solid-state components. If hazards due to accidental contact with moving machinery or unintentional flow of liquid, gas or solids exist, an additional hardwired stop circuit is required to remove AC line power to the drive. When AC input power is removed, there will be a loss of inherent regenerative braking effect and the motor will coast to a stop. An auxiliary braking method may be required.

Figure 2-17.
Control Scheme

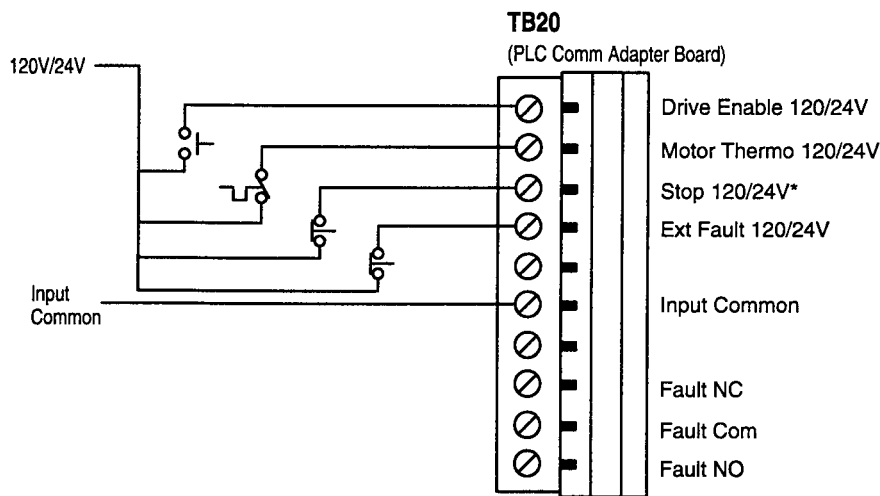

Note: Terminal Blocks TB20 & TB21 are pull apart terminal blocks to aid in making cable connections. Both terminal blocks will accept wire sizes from 30-12 AWG (0.06 – 3.3 mm²).

*This is a configurable stop, see parameter 59 under the Drive Logic group for Start and Stop options.

Start-Up

Introduction

This chapter describes the procedure for the proper start up and tuning of the 1336 FORCE AC drive. Among the procedures you must perform in this chapter are the following:

- Pre-power checks
- Power-on checks
- Communication Configuration
- Parameter Programming
- Motor and Feedback Polarity Checks
- Drive Tuning and Calibration

Safety Precautions



ATTENTION: Only qualified personnel familiar with the 1336 FORCE AC Drive and its associated machinery should plan and implement the installation, startup and subsequent maintenance of the Drive. Failure to comply may result in personal injury and/or equipment damage.



ATTENTION: Working with energized industrial control equipment can be hazardous. Severe injury or death can result from electrical shock, burn, or unintended actuation of controlled equipment. Hazardous voltages may exist in the cabinet even with the circuit breaker in the off position. Multiple sources of power may be connected to this drive. Recommended practice is to disconnect and lock out control equipment from power sources, and discharge stored energy in capacitors, if present before coming in contact with any equipment in this cabinet. During startup it will be necessary to work in the vicinity of energized equipment. The Safety Related Practices of NFPA 70E, "ELECTRICAL SAFETY FOR EMPLOYEE WORKPLACES" must be followed at all times. **DO NOT** work alone on energized equipment!



ATTENTION: Potentially fatal voltages may result from improper useage of an oscilloscope and other test equipment. The oscilloscope chassis may be at potentially fatal voltage if not properly grounded. Avoid using the oscilloscope to measure high voltage signals. In most cases the waveform can be obtained from a low level test point. If an oscilloscope is used to measure high voltage waveforms, use only a dual channel oscilloscope in the differential mode with X-100 probes. It is recommended that the oscilloscope be used in the A minus B Quasi-differential mode with the oscilloscope chassis grounded to an earth ground. Refer to equipment safety instructions for all test equipment before using with the 1336 FORCE Drive.



ATTENTION: This Drive contains ESD (Electro-Static Discharge) sensitive devices. Static control precautions are required when installing, testing, servicing or repairing this assembly. These precautions should be applied when working with logic boards AND any components in the power section. A properly grounded wrist strap should be worn when contacting any component in the drive. If you are not familiar with static control procedures, before servicing, reference Allen-Bradley Publication 8000-4.5.2, Guarding against Electrostatic Damage or any other applicable ESD protection handbook.

Required Tools and Equipment

The following equipment is required for start-up and tuning.

- Digital Multimeter (DMM) capable of 1000V DC/750V AC, with input resistance of at least 1 megohm.
- Hand Tachometer used to monitor motor velocities.
- User Manuals for optional equipment.
- DriveTools Software (optional)

This start-up sequence specifies using hand instruments such as multimeters, tachometers, ammeters and an oscilloscope to carry out this start-up test procedure. If you have the optional DriveTools software for the 1336 FORCE Drive, it can be used to simplify the startup procedure. This option can be used to set input commands, manipulate parameters and verify frequencies and voltage levels.

IMPORTANT: With a Series A 1336 FORCE drive it is necessary to use either a PLC or DriveTools to carry out the Startup. Performing a Startup sequence with any programming terminal such as a GPT or HIM **SHOULD NOT** be attempted with a Series A drive.

Drive Information

During Startup the following information should be recorded for reference. It is important that an accurate list of drive components be maintained and referred to when contacting service personnel.

Table 3-A. Data Checks –

DRIVE NAMEPLATE DATA

Catalog Number: _____
 Serial Number: _____
 Series: _____
 AC Input _____ Volts _____ Amps
 AC Output _____ Volts _____ Amps
 Horsepower Rating: _____ kw _____

MOTOR NAMEPLATE DATA:

Catalog Number: _____
 Serial Number: _____
 Series: _____
 AC Input _____ Volts _____ Amps
 Horsepower Rating: _____ kw _____
 Poles: _____
 RPM: _____
 Hz: _____

ENCODER NAMEPLATE DATA:

Catalog Number: _____
 Serial Number: _____
 Series: _____
 Input Power Supply: _____ Volts
 Input Signal Level: _____ Volts
 Output Type: _____
 Pulses Per Rev: _____ PPR
 Maximum Speed: _____
 Maximum Frequency: _____

MOTOR CONTROL BOARD:

Board Revision Level: _____

PLC COMM BOARD:

Board Revision Level: _____

GATE DRIVER BOARD:

Board Revision Level: _____

STANDARD ADAPTER BOARD:

Board Revision Level: _____

PLC Comm Adapter Board Jumper Settings:

U2: 1__ 2__ 3__ 4__ 5__ 6__ 7__ 8__
 U3: 1__ 2__ 3__ 4__ 5__ 6__ 7__ 8__
 U4: 1__ 2__ 3__ 4__ 5__ 6__ 7__ 8__
 U5: 1__ 2__ 3__ 4__ 5__ 6__ 7__ 8__

General

Only qualified electrical technicians and/or electrical engineers familiar with solid state controls and circuitry should attempt a 1336 FORCE start-up. Figure 3.1 outlines the sequence that is required to start-up the 1336 FORCE Drive.

Figure 3.1.
Bulletin 1336 FORCE Start-Up Sequence

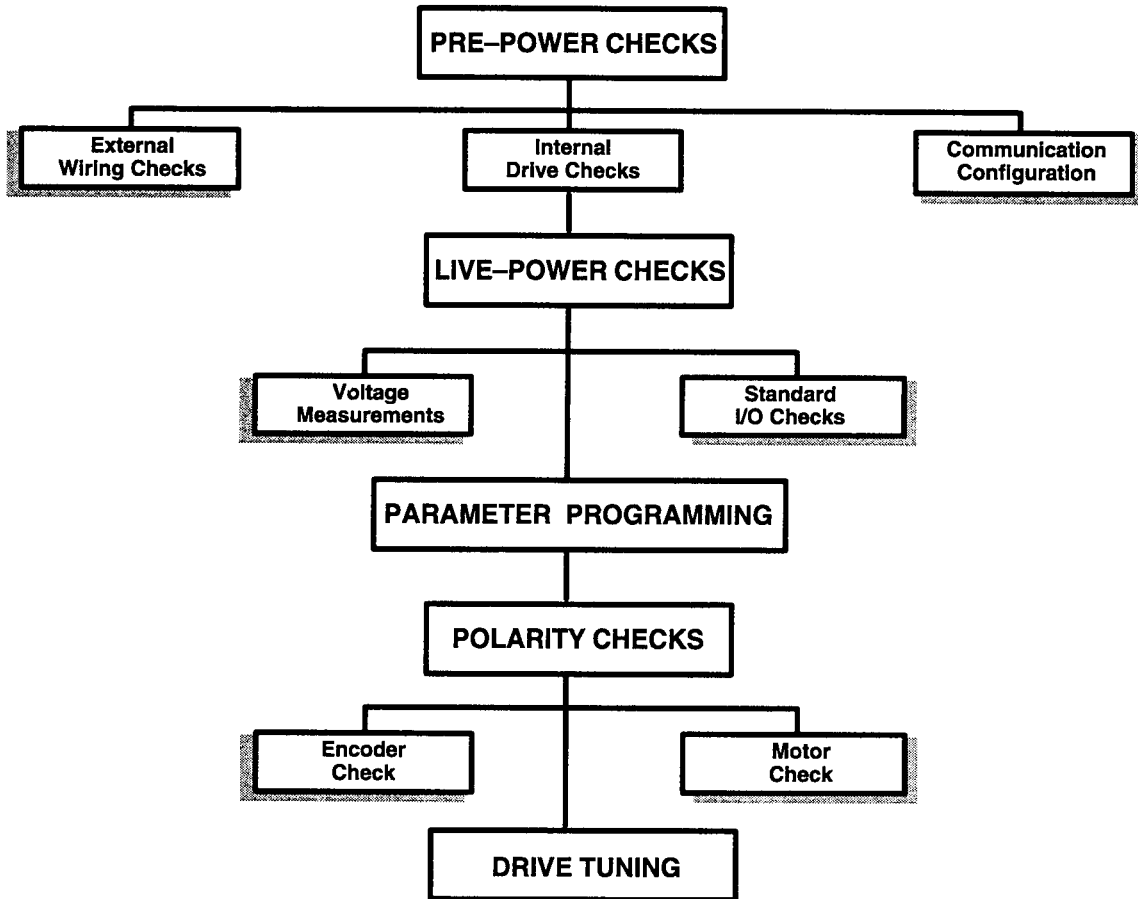

Pre-Power Checks

Pre-Power checks are meant to identify any problems prior to applying voltage to the system. The drive should be checked for any damage that may have occurred during shipment and installation. You should also verify that all jumpers and configuration controls are properly applied for the application at hand. Finally, you must check all wiring external to the drive for accuracy and reliability.

External Wiring Checks:

1. Verify that all external I/O wires are properly terminated in the terminal blocks. A full point – to – point continuity check should be performed on all I/O wiring connected to the drive.
2. Verify that the incoming power connections are properly connected and tight. Also verify that the power source is properly sized and protected for your particular drive.

3. Verify that the motor power connections are properly connected and tight. Motor Phasing should be checked, Motor Phase A should be connected to Drive output phase A, likewise Phase B and C should be properly terminated to their respective terminals. This phasing will be double checked later in this procedure.
4. Verify that the encoder feedback device is properly connected. The encoder should be a quadrature device with a 12V input power requirement and either 12V or 5V differential outputs. Jumpers J3 and J4 on the Main Control Board (Figure 2.7) must be set for the desired output. Phasing of the encoder should be checked in that A and /A, B and /B are properly terminated. This phasing will be double checked later in this procedure.
5. Verify that the standard I/O inputs on the PLC Comm Board are configured for the proper input voltage level. The Standard I/O can be configured for operation at 24V DC or 120V AC. To select the proper voltage set the jumpers on J5, J6, J7 and J8 across pin 1 and 2 if the input voltage level is 120V AC, and across pins 2 and 3 if the input voltage level is 24V DC.

Communication Configuration

Drive to Drive Communication – Drive to Drive Communication (D2D) provides high speed communications between drives based on a Control Area Network (CAN) chip. D2D is capable of connecting up to 64 Drives together using three different transfer rates, 125K (64 nodes), 250K (64 nodes), and 500K (32 nodes) baud.

Hardware Setup – The hardware setup for D2D consists of a shielded cable going from CN+ and CN– between the drives. The shields are to be tied together and grounded at one point. Place a 120Ω terminating resistor on both ends of the cable. The 8 –18 VDC that powers the D2D is to be supplied by the customer. Figure 3.2 shows a typical D2D connection. Recommended cable is Device–Net cable (Belden YR 29832).

Figure 3.2.
Drive to Drive Hardware Connection

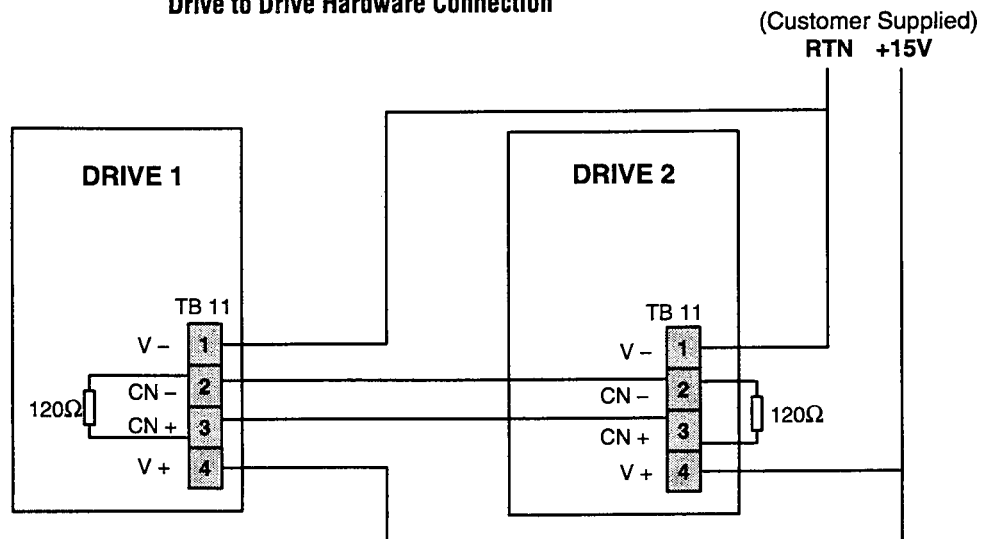

Communication – The D2D allows each drive to transfer two words and receive two words from two different drives for a total words received of four (Figure 3.3).

Figure 3.3.
D2D Communication

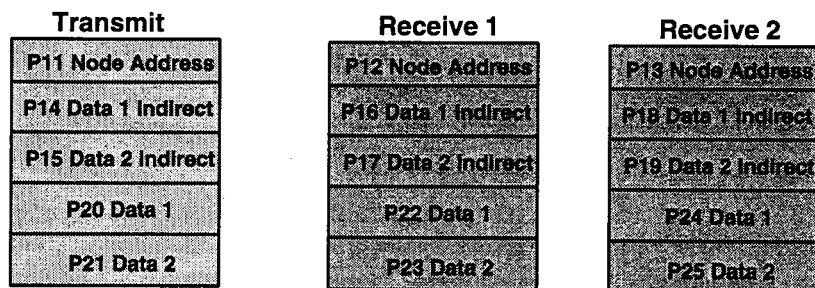

Node Address – The node address for the transmit is the address at which the drive will transmit its two words of data. The node address for each of the receives is the address of the drive which you wish to receive two words of data from. If the node address is set to zero then the transmit or receive is disabled. It is up to you to make sure there are no duplicate transmit node addresses. If duplicate addresses exist, you must change one address. Refer to the example in Figure 3.4.

Figure 3.4.
Node Address Transmittal

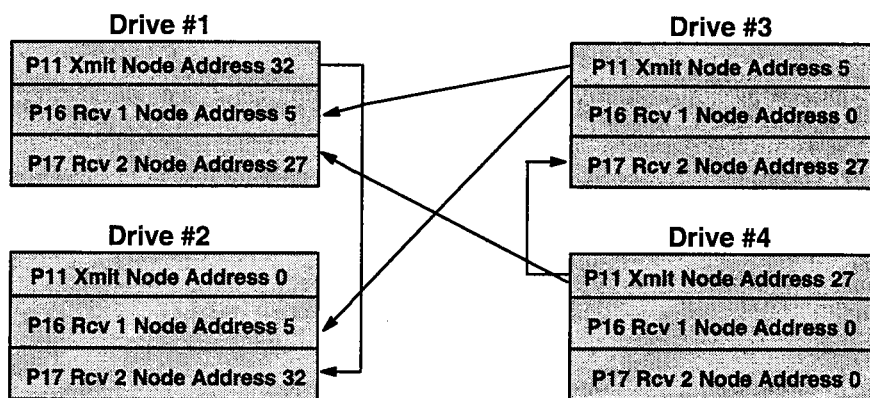

Note that a drive cannot receive its own address and both receives cannot be set to the same address unless it is zero.

Data Indirect – The indirect function for the transmit indicates to the D2D transmit (TX) where it should take data from. The receive it indicates to the D2D receive (RX) where it should put its data. Indirect parameters can have either VP parameters entered into them, or they can have indirect data parameters entered into them as shown in the following examples.

Transmitter Example:

P14 Drive Transmit indirect 1 – Any VP Parameter
 or – P20 (Drive Xmit Data 1)
 P20 would then have a value or be linked to a non VP parm.

Receiver Example:

P16 Drive Receive Indirect 1 – Any VP Parameter
or – P22 (Receive 1, Data 1)

P22 would then have a value or a non VP parm linked to it.

Data – The D2D TX and RX data exists as non VP parameters in the parameter table. This allows data outside the Motor Control Board to get access to the D2D. Data parameter examples were shown in the previous transmitter and receiver examples.

Master/ Slave Drive to Drive Communication – Figure 3.5 illustrates an example of D2D applied to a master/slave drive set up. The master drive receives its speed reference from a speed pot wired to analog input 1 on a PLC Comm board. P339 (Analog In1) is linked to P101 (Ext Vel Ref) on the master drive. P392 (Analog In 1 Offset) and P393 (analog In1 Scale) are set accordingly. Analog Input 1 must be passed from the master drive to the slave drive and connected to the P101 (Ext Vel Ref) using the D2D protocol.

Setting up the Master drive requires that a transmit address be chosen. An address 1 is chosen in this example. P14 (Drive Xmit Indirect 1) will have a value of 20 entered into it (which means look to P20 (Drive Xmit Data 1)). P20 (Drive Xmit Data 1) must be **linked** to P339 (Analog In1). This is where the data comes from that will be transmitted.

**Figure 3.5.
Master/Slave Communication Example**

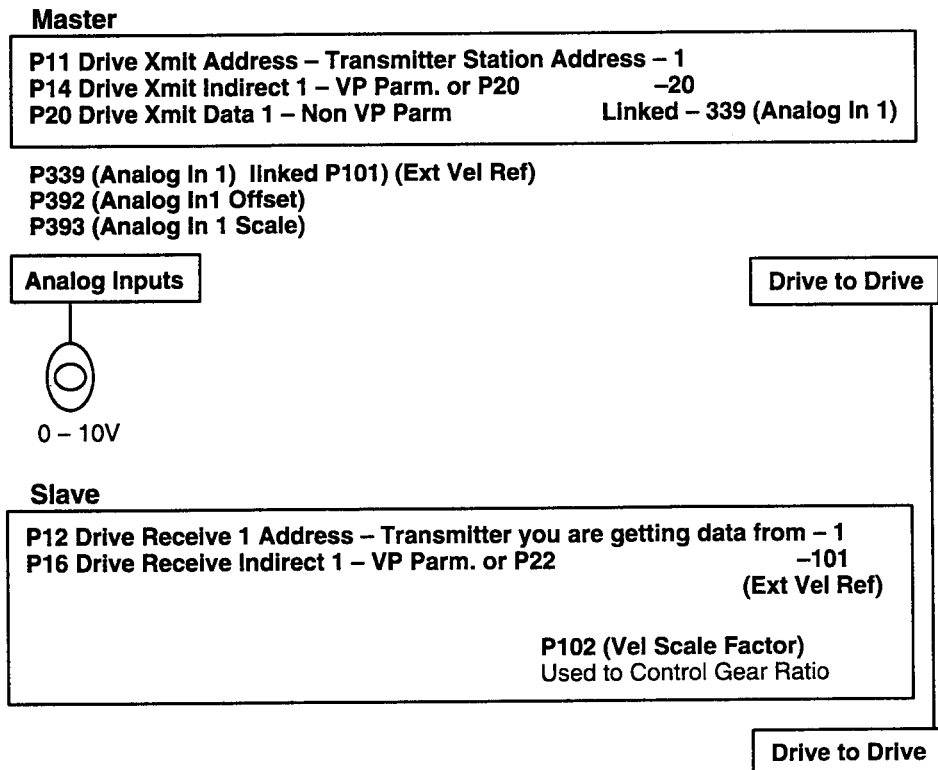

The slave drive is set up by first setting P12 (Drive Receive 1 Address). P12 contains the address of the transmitter that you wish to receive data from. In this example, a value of 1 is entered, indicating that data should be read from transmitter 1. P16 (Drive Receive Indirect 1) should be set to P101 (Ext Vel Ref). It should be noted that the typical transmission **time** from the master to the slave is between **4ms to 6ms** using links, otherwise using indirects it is only 2ms to 4ms.

PLC Comm Plug Configuration – The PLC Comm Adapter incorporates an Allen–Bradley Communication Plug which is preset. Verify that the Plug (Figure 3.6) is configured correctly for your application by checking the PLC Comm Adapter User Manual.

Figure 3.6.
PLC Comm Adapter Plug Configuration

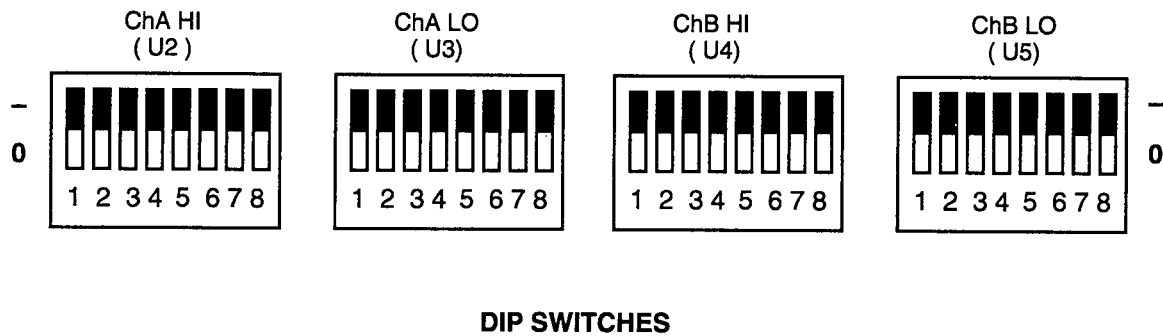

Power On

After all pre-power checks have been completed, the incoming power may be applied. The application of power for each system can be different. Make sure you know the safety controls associated with the system. Power should only be applied if you have a thorough understanding of the 1336 FORCE Drive and the associated system design.

1. Measure the incoming line voltage between L1 and L2, L2 and L3, and L1 and L3. Use the DMM on AC Volts, highest range (1000 VAC). The input voltage should equal the drive rated input voltage present on the drive's nameplate within +/-10%. If the voltage is out of tolerance, verify the drive rating is correct for the application, if it is, adjust the incoming line voltage to within +/-10%. Record these measurements in the Voltage Measurement Table.
2. Measure the Motor Control Board Power Supply voltages. Record the measurements in the Voltage Measurement Table 3B.
3. Measure the PLC Comm Board Power Supply voltages. Record the measurements in the Voltage Measurement Table 3B.
4. If a Standard Adapter Board is supplied, measure the Standard Adapter Board Supply Voltages. Record the measurements in the Voltage Measurement Table 3B.
5. Measure the Standard I/O input voltage. This voltage is user selectable and should be either 120VAC or 24VDC nominally. Record the voltage level in Table 3-B.

Table 3-B. Voltage Measurement Table

Test Points	Expected Voltage	Measured Voltage
L1 to L2	Rated AC Line	
L2 to L3	Rated AC Line	
L1 to L3	Rated AC Line	
Motor Control Board:		
TP1 to TP2	4.85 to 5.10V	
TP3 to TP4	13 to 17V	
TP5 to TP4	-13 to -17V	
TP26 to TP27	10.4 to 13.6V	
PLC Comm Board:		
TP1 to TP2	4.85 to 5.10V	
TP4 to TP3	13 to 17V	
TP4 to TP5	-13 to -17V	
TP19 to TP14	10.4 to 13.6V	
Base Driver Board:		
J2 to J2	4.85 to 5.10V	
J2 to J2	11 to 17V	
J4 to J4	10.5 to 13V	
Standard I/O Voltage	120VAC +/-10%	
J3, 8, 9 or 10 to J3	or 24VDC +/-10%	

Communication Configuration:

The Standard I/O of the 1336 FORCE Drive should be checked to verify proper operation. The Standard I/O is used to interface control circuits into the drive. It is very important that this interface is functioning properly.

1. The DRIVE ENABLE (TB20 terminal 1) on the PLC Comm Board input allows the drive to honor a START command and allows the transistor firing commands to be enabled. D21 on the PLC Comm board, a green LED, reflects the present state of the DRIVE ENABLE. If D21 is illuminated, then the drive is enabled and the transistors will be allowed to fire. Parameter 54 bit 1 also reflects the status of the DRIVE ENABLE input.
2. The EXTERNAL FAULT (TB20 terminal 4) PLC Comm input allows you to tie a signal into the 1336 FORCE that will be monitored by the Velocity Processor (VP). If the input voltage is removed, the VP will issue a fault or warning based on the configuration of that fault and the red LED D16 on the PLC Comm board will be illuminated. When Input voltage is applied, D12 will not be illuminated.
3. The MOTOR THERMOGUARD (TB20 terminal 2) input allows you to tie a signal from the thermo-switch in the motor into the 1336 FORCE that will be monitored by the Velocity Processor (VP). The red LED D18 will illuminate if an overtemp condition occurs.
4. The NORMAL STOP (TB20 terminal 3) input is stop command that will stop the drive according to the specified Stop Mode. The drive responds the same way it would if the STOP bit were set in any Logic Command. The red LED D13 reflects the present state of the STOP input. When a Stop is in effect the LED is illuminated and the Drive is not allowed to run.
5. The FAULT OUT (TB20 terminals 8,9,10) input is a Form C relay contact. Red LED D11 reflects the status of relay contact. If the LED is illuminated the contact is not energized.

Startup Configuration Procedures

After you have completed all wiring and power up the drive, the parameter configuration procedure must be completed in a two step sequence.



ATTENTION: Failure to complete the parameter configuration in Steps 1 and 2 could result in injury to personnel, or damage to the drive and the motor, when attempting to perform the remaining steps in the Configuration Procedure.

You must perform parameter configuration in the following order:

1. Set P310 to a value of 1. This will allow access to the Advanced Programming Parameters.
2. Enter the values for all Inverter Parameters (220 – 227).

IMPORTANT: The carrier frequency (Parm 222) for 125 HP and larger drives must remain at 4 KHz or lower. If the carrier frequency is increased, the output current must be derated due to heating effects caused by the increase in carrier frequency.

3. Enter the values for all Motor Parameters (228 – 235).
4. Perform the Phase Rotation test only after entering all Inverter and Motor parameter values.



ATTENTION: During Startup the motor will rotate. Hazard of personal injury exists due to unexpected starts, rotation in the wrong direction or contact with the motor shaft. If possible, uncouple the motor from the load and place a guard around the motor shaft.

Phase Rotation Test:

Typically the default values are adequate to perform the phase rotation test. Toggle the start bit in the logic command in order to start the test. When using default values, the motor shaft will rotate at approximately 85 RPM for a 4 pole, 60 Hz motor.

Interpreting Phase Rotation Results:

1. In phase rotation, the motor should turn in the direction you define. If the motor turns in the wrong direction, reverse any two motor leads.
2. In phase rotation with the motor now turning in the correct direction, the sign of the velocity feedback (P146) should be positive. If it is negative, reverse the A and /A (NOT A) encoder leads or the B and /B (NOT B) leads.
3. If no motor rotation occurs, refer to the troubleshooting section of the manual.

Torque Block Tuning:

The Torque Block can be tuned by setting bits 2 thru 5 in parameter 256 to a value of one, and executing a Start command.

During this test the Drive enable light will come on for approximately 1 minute with no motor rotation. After this one minute time period, shaft rotation will occur. Once the shaft stops rotating, the Drive enable light will go out, and bits 2 thru 5 in Parameter 256 will be set to a value of zero. This indicates a successful Torque Block tune. If the Drive faults during the Torque Block tuning, verify the Motor and Inverter data and re-execute the test. If continued problems occur, refer to the Troubleshooting section; Sequential Torque Block tuning.

Velocity Loop Tuning: You must use the following sequence when tuning the Velocity Loop:

1. Set **Parameter 53** to a value of 1 (Bit 0 = 1). This sets the drive in velocity mode.
2. Set **Parameter 40** (Autotune Torque Limit) to a value of 75%.
3. Set **Parameter 41** (Autotune Speed Limit) to a value of 75%.
4. Set **Parameter 256** (Bit 6 = 1) to a value of 64. This will enable the Motor Inertia Test.
5. Toggle the Start bit in the logic command.
IMPORTANT: this must be done within 30 seconds of entering a value in **Parameter 256**.
While the Velocity Loop test is being performed, the motor will accelerate up to 20% of base speed, and then accelerate to the speed set in **Parameter 40** before decelerating to zero speed. The Enable light will go off when the test is finished.
6. To update the velocity loop gains, set Bit 8 to a value of 1 in **Parameter 256**. The maximum bandwidth will appear in Parameter 44.
7. Enter the desired bandwidth in **Parameter 43**. Note: Both the Ki & Kp gains in Parameters 139 and 140 will change depending on the value entered in **Parameter 43**.
NOTE: **Parameter 141** KF will also affect the values that are calculated for both Parameter 139 and Parameter 140. Leave Kf = 1 for initial tune.
8. After you have entered the desired bandwidth in **Parameter 43**, and the gains have been updated in Parameters 139 and 140, set **Parameter 256** back to a value of zero.

9. Now you will be able to start the drive in Velocity Mode. Begin by giving the Drive a small speed reference. Slowly increase the drive speed reference, observing both Parameter 146 (Velocity Feedback) and Parameter 167 (Internal Torq Ref). Both of these parameters should be stable during steady state conditions. If they are not, adjust Kp and Ki accordingly, if the steady state condition cannot be obtained, perform another Velocity Loop Tuning sequence. After you are able to successfully run the motor in velocity mode by itself, it should be connected to the process and the system inertia test should be performed,

System Inertia Test: With the motor connected to process, the following test sequence must be followed:

1. Set Bit 7 to a value of 1 in parameter 256.
2. After the appropriate value is set in Parm 256, a Start command should be given to the drive. When started, the motor will accelerate up to 20% of base speed, and then accelerate to the speed set in parameter 40 before decelerating to zero speed. The enable light will go off when the test is finished, and the value in P256 will be set to a value of 0.
3. After successful completion of the inertia measurement, whether motor inertia or system inertia, Bit 8 of parameter 256 should be set. This allows bandwidth calculations to be made automatically. The bandwidth calculations are based on the value that is displayed in Parm 44 (maximum Bandwidth). Parm 43 (Desired Bandwidth) is where the user will enter the desired Bandwidth display in X.XX rad/ sec. Both Parm 139 (Velocity KI Gain) and 140 (Velocity KP Gain) gains will change according to the bandwidth entered in Parm 43. Parm 43 must be less than or equal to the value displayed in Parm 44.

NOTE: Parameter 141 (Velocity Feedforward) will also affect the values that are calculated for both Parm 139 & 140. Leave Kf = 1 for Initial tune.

4. After you have entered the desired bandwidth in Parmeter 43, and the gains have been updated in Parameters 139 and 140, set Parameter 256 back to a value of zero. This will prevent Parm 139 and Parm 140 from changing if Parm 43 were to be accidentally changed.
5. Now you are ready to start the drive in Velocity Mode.

The drive can be started using Preset Speed 1 (P119) for a reference by turning on Bits 13 & 1 in Parm 367. To stop the Drive enter a value of 1 in Parm 367.

6. Begin by putting a small reference in Parm 119 (approximately 10% of Base Speed).

Observe the motor shaft, making sure it has stable rotation. Slowly increase the drive speed reference observing both Parameter 146 (Velocity Feedback) and Parameter 167 (Torq Ref). Both of these parameters should be fairly stable during steady state conditions. If they are not, adjust Kp and Ki accordingly, if the steady state condition cannot be obtained, perform another Velocity Loop Tuning sequence.

***** IF YOU ARE USING A PLC COMM BOARD**

The analog outputs on a PLC Comm Board can be used to link the Velocity Feedback (parm 146) and Torq Reference (Parm 167). When these outputs are linked, a chart recorder can be connected to the Analog Output channels. This will allow the user to record the drives response to given changes in the reference.

Troubleshooting

General

Chapter 4 provides information to guide you in troubleshooting the 1336 FORCE. The 1336T (FORCE) Drive employs extensive diagnostics to aid in correcting many malfunctions that may occur in the system. This guide is designed to help you interpret the diagnostic response of the Drive when a malfunction occurs. Possible corrective measures will be explained to help you get the Drive repaired or functional as quickly as possible for most types of malfunctions.



ATTENTION: Only qualified personnel familiar with the 1336 FORCE drive system and the associated machinery should perform troubleshooting or maintenance functions on the Drive. Failure to comply may result in personal injury and/or equipment damage.

During Start-up the following information should have been recorded for reference during troubleshooting. If it was not, record the following at this time:

- Software Version numbers should be recorded for each board. These are necessary to assist on-site personnel or when calling for assistance.
- Drive and motor nameplate data should have been recorded at start-up and maintained for ready reference during troubleshooting. Many systems do not allow for easy access to the motor after start-up. If the motor nameplate data was not recorded previously, do so at this time.

Required Equipment

For initial troubleshooting, a programming device is required to read fault codes. In addition to a programming device, the following should be available before initiating any troubleshooting procedures:

- Digital Multimeter (DMM) capable of 1000V DC/750VAC, with one megohm minimum input impedance.
- Clamp on Ammeter (AC/DC) with current ratings to 2X rated current output of 1336 FORCE AC Drive.
- Dual trace oscilloscope with differential capability, digital storage, two X10 and one X100 calibrated probes (optional but recommended).
- Hand tachometer used to monitor motor velocities.
- Programming Device Instruction Manual and Adapter Board Reference Manuals.

Fault Descriptions

Fault Display – Faults are indicated by showing a decimal number of up to 5 characters relating to the fault (Figure 4.1) or by flashing LED sequences on the Motor Control Board. The fault will be displayed until a Drive reset is initiated. Refer to Tables 4.A & 4.B for a listing and description of the various faults. When applicable, a possible solution will also be provided.

Figure 4.1
Typical Fault Description Display

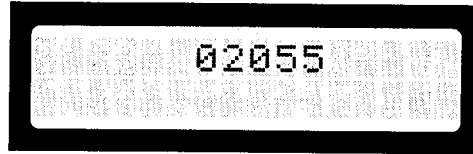

Fault Code Definition – The fault code is a 5 character decimal number that is defined as follows:

SAXXX S = Source Designator
A = Area Designator
XXX = Internal Fault Code (0 thru 999)

The Source Designator (S) is the 1st digit of the number:

- 0 = Main Board Velocity Processor (VP)
- 1 = Main Board Current Processor (CP)
- 2 = Reserved
- 3 = Adapter Processor (PLC Comm etc.)
- 4 = Domino Processor (DP)
- 5 = Reserved

Area Designator (A) is the 2nd digit of a number:

- 0 = General
- 1 = Motor
- 2 = Inverter
- 3 = Mtr Control
- 4 = Adapter
- 5 = External Device
- 6 = Communications
- 7 = Reserved
- 8 = Reserved
- 9 = Converter/Brake

Internal Fault Code (XXX)

The internal fault codes (last three digits of number) are identified in Table 4.A thru 4.C.

Table 4.A
1336 FORCE Motor Control Fault Descriptions

Fault #	LED	Description	Parameter #	Bit #
13000	CP, Red 1 blink	CP EPROM Fault	80	00
13001	CP, Red 2 blink	CP Internal RAM Fault	80	01
13002	CP, Red 3 blink	CP External RAM Fault	80	02
13003	CP, Red 4 blink	CP Stack RAM Fault	80	03
13004	CP, Red 5 blink	VP MBI Failure (Dual Port)	80	04
03008	VP, Red 1 blink	VP EPROM Fault	80	08
03009	VP, Red 2 blink	VP Internal RAM Fault	80	09
03010	VP, Red 3 blink	VP External RAM Fault	80	10
03011	VP, Red 4 blink	VP Stack RAM Fault	80	11
03012	VP, Red 5 blink	CP MBI Failure (DualPort)	80	12
03013	VP, Red 6 blink	AP MBI Failure (MECO DualPort)	80	13
03014	VP, Red steady	Power Driver Board EEPROM Fault	80	14
12016	CP, Solid Red	Bus Overvoltage	81	00
12017	CP, Solid Red	Transistor Desat	81	01
12018	CP, Solid Red	Ground Fault	81	02
12019	CP, Solid Red	IOC	81	03
14020	CP, Solid Red	SW Malfuction (AP Hndshk)	81	04
16021	CP, Solid Red	Master/Slave Cable Loss	81	05
16022	CP, Solid Red	Master/Slave Enable Timeout	81	06
04024	VP, Solid Red	AP Handshake Error	81	08
03025	VP, Flashing Red	Absolute Overspeed	81	09
03026	VP, Flashing Red	Analog Supply Tolerance	81	10
12027	CP, VP, Flash Red	Diagnostics Failure	81	11
12028	VP, Solid Red	Inverter Overtemperature Trip	81	12
13029	VP, Solid Red	Software Malfuction – VP	81	13
12032	CP, Flashing Red	Ridethrough Timeout	82	00
12033	CP, Flashing Red	Precharge Timeout	82	01
12034	CP, Flashing Red	Bus Drop	82	02
12035	CP, Flashing Red	Bus Undervoltage	82	03
12036	CP, Flashing Red	Bus Drop Cycles >5	82	04
05048	VP, Flashing Red	Velocity Feedback Loss	83	00
02049	VP, Flashing Red	Inverter Overtemp Pending	83	01
01050	VP, Flashing Red	Motor Overtemp	83	02
01051	VP, Flashing Red	Motor Overload Pending	83	03
01052	VP, Flashing Red	Motor Overload Tripped	83	04
01053	VP, Flashing Red	Motor Stalled	83	05
05054	VP, Flashing Red	External Fault Input	83	06
03057	VP, Flashing Red	Parameter Limit	83	09
03058	VP, Flashing Red	Math Limit	83	10
09059	VP, Flashing Red	Dynamic Brake Overtemperature	83	11
02060	VP, Solid Red	AC Contactor Failure	83	12
02061	VP, Flashing Red	Inverter Overload pending (IT)	83	13
06062	VP, Flashing Red	Drive to Drive Error	83	14

Note: The first digit in the 5 character fault number for PLC Comm Board faults indicates the source as follows:

- 0 = Velocity Processor (VP)
- 1 = Current Processor (CP)
- 2 = Adapter Processor (PLC Comm etc.)
- 3 = Domino Processor (DP)

The Area Designator (2nd digit) and internal fault codes (last three digits) remain the same as described under the Fault Code Definition on page 4-2.

Table 4.B
1336 FORCE PLC Comm Adapter Fault Descriptions

Fault #	Description	Fault Text
24000	Faults Cleared/No Fault exists	Clear Faults
24009	Soft Fault – Adapter BRAM checksum fault	Adpt BRAM Cksm
24012	Soft Fault – Main Board Bram checksum fault	Main BRAM Cksm
34001	DP-PSD RAM code	SW Malfunction
34002	DP-RAM	SW Malfunction
34003	DP-Checksum (code)	SW Malfunction
34004	Domino interface	SW Malfunction
34005	DP/AP dual port RAM	SW Malfunction
24013	Hard Fault – Integrity Check on Board Failed	SW Malfunction
24014	Hard Fault – Integrity Check on Board Failed	SW Malfunction
24015	Hard Fault – Integrity Check on Board Failed	SW Malfunction
24016	Hard Fault – Integrity Check on Board Failed	SW Malfunction
24017	Hard Fault – Integrity Check on Board Failed	SW Malfunction
24018	Hard Fault – Integrity Check on Board Failed	SW Malfunction
25023	No Adapter Language Module Present	No AP LM exists
25024	No Main Board Language Module present	No MC LM exists
24025	PLC Comm Bd SW/LM version mismatch	AP SW/LM Rev Err
24026	Soft Fault – Dip switch settings on Adapter incorrect	Adptr Config Err
34001	Hard Fault – Integrity Check on Board Failed	HW Malfunction
34002	Hard Fault – Integrity Check on Board Failed	HW Malfunction
34003	Hard Fault – Integrity Check on Board Failed	HW Malfunction
34004	Hard Fault – Integrity Check on Board Failed	HW Malfunction
34005	Hard Fault – Integrity Check on Board Failed	HW Malfunction
34006	ChA Protocol Fault	ChA Protocol
34007	ChB Protocol Fault	ChB Protocol
34008	ChA Baud Rate	ChA Baud Rate
34009	ChB Baud Rate	ChB Baud Rate
34010	ChA Rack Size	ChA Rack Size
34011	ChB Rack Size	ChB Rack Size
34012	ChA Module Group	ChA Module Group
34013	ChB Module Group	ChB Module Group
34014	RIO redundant–diff rack size	Redund Rack Size
34015	RIO redundant–diff protocols	Redund Diff Prot
34016	Hard Fault – Integrity Check on Board Software Failed	HW Malfunction

Table 4.B
1336 FORCE PLC Comm Adapter Fault Descriptions cont.

Fault #	Description	Fault Text
36019 36020	ChA Duplicate DH+ Node Addr's ChB Duplicate DH+ Node Addr's	ChA Dup Nodeaddr ChB Dup NodeAddr
24027	FB INTERNAL ERROR	FB Internal Err
24028	FB INVALID LINK ERROR	Invalid FB Link
24029	FB I/O LIMIT ERROR	FB I/O Lim Err
24030	FB MEM ALLOCATION ERROR	FB Mem Alloc Err
24031	FB Event Value ERROR	FB Event Value Err
24032	FB BLOCK NUMBER LIMIT ERROR	At FB Block Lim
24034	FB BRAM CHECKSUM ERROR	FB BRAM CHECKSUM ERROR
24035	FB INTERNAL ERROR	FB Internal Err
24036	FB EXECUTION TIME LIMIT	FB Exe Time Lim
24037	FB BRAM is Not Initialized	Init FB BRAM Fit
26038	Device connected to Scanbus Port 1 disconnected	SB PT 1 Timeout
26039	SB Port 2 timeout	SB PT 2 Timeout
26040	SB Port 3 timeout	SB PT 3 Timeout
26041	SB Port 4 timeout	SB PT 4 Timeout
26042	SB Port 5 timeout	SB PT 5 Timeout
26043	SB Major Fault	SB Comm Fault
36021	ChA Comm loss	ChA Comm Loss
36022	ChB Comm loss	ChB Comm Loss
36023	ChA Reset program test	ChA Prg/Res/Test
36024	ChB Reset program test	ChB Prg/Res/Test
36025	Ch A Rack Fault	Ch A Rack Fault
36026	Ch B Rack Fault	Ch B Rack Fault
24044	FB Near Memory limit WARN 0	FB Near Mem Lim
24045	FB Illegal event downloaded WARN 1	FB DNLD Bad Evnt
24036	FB WARN 2	
24037	FB WARN 3	
24038	FB WARN 4	
24040	FB WARN 5	
24039	FB EVENT LIST CHECKSUM WARN 6	
24041	FB WARN 7	
24042	FB WARN 8	
24046	FB Bad Packet Number	FB BAD PKT NUM
24048	FB Illegal Event Download WARN	FB DNLD Bad Event
24049	FB Block Number Warning	FB DNLD BLK # Warn
24050	FB Event List checksum warning	FB Dnld Cksm Wrn
24052	FB Near execution limit warn	FB NEAR EXEC LIM

Fault/Warning Handling

The lights on the motor control board indicate the status of the Current and Velocity processors. Both the Current and Velocity processors have both Green and Red LED's associated with their status. Table 4.D displays the meaning of the CP and VP status lights.

Table 4.C
CP and VP Status

VP LED	CP LED	Status	Meaning
D2	D4	Solid Green	Drive Hard Fault
D2	D4	Flashing Green	Drive Soft Fault
D3	D5	Flashing Red	Drive Warning
D3	D5	Solid Red	No Fault

Hard Fault – A Drive hard fault is a fault that trips the Drive causing it to coast to a stop. This type of fault requires the user to perform a Drive Reset to remove the fault.

Soft Fault – A Drive soft fault will also cause the drive to trip and coast to a stop. This type of fault can be removed by doing a Clear Faults command after the condition that caused the Drive to trip has been removed.

Drive Warning – A Drive Warning is simply an undesirable condition that exists within the Drive. It will not cause the Drive to trip. A Clear Faults command after the warning condition has been alleviated, will remove the warning.

Everytime the Drive has any of the faults or warnings described above, a fault/warning message is logged in either the fault or warning queue. This is designed to aid in troubleshooting.

Motor Control Board Faults & Warnings – There are two types of fault and warning queues for the Motor Control Board, configurable and nonconfigurable.

Configurable Faults & Warnings – The configurable fault queue contains faults that can be set up to either trip the drive or provide only a visual warning while the drive continues to operate.

Nonconfigurable Faults & Warnings – The nonconfigurable fault queue contains faults that the user can't shut off. These faults are the result of a condition that could damage the Drive if allowed to persist. The non-configurable fault queue faults can be viewed in parameter 81 (Fig. 4.2).

In addition to configurable & non-configurable faults, there are the "powerup faults".

Powerup Faults – The powerup faults appear in parameter 80 (Fig. 4.3). These faults primarily consist of problems that could occur with powerup of both the current and velocity processors.

Adapter Board Faults – Adapter board faults are setup and displayed in separate parameters from the Motor Control Board. For a list of adapter board faults, refer to your adapter board manual.

Figure 4.2
Parameter 81 (Non-configurable Fault Status)

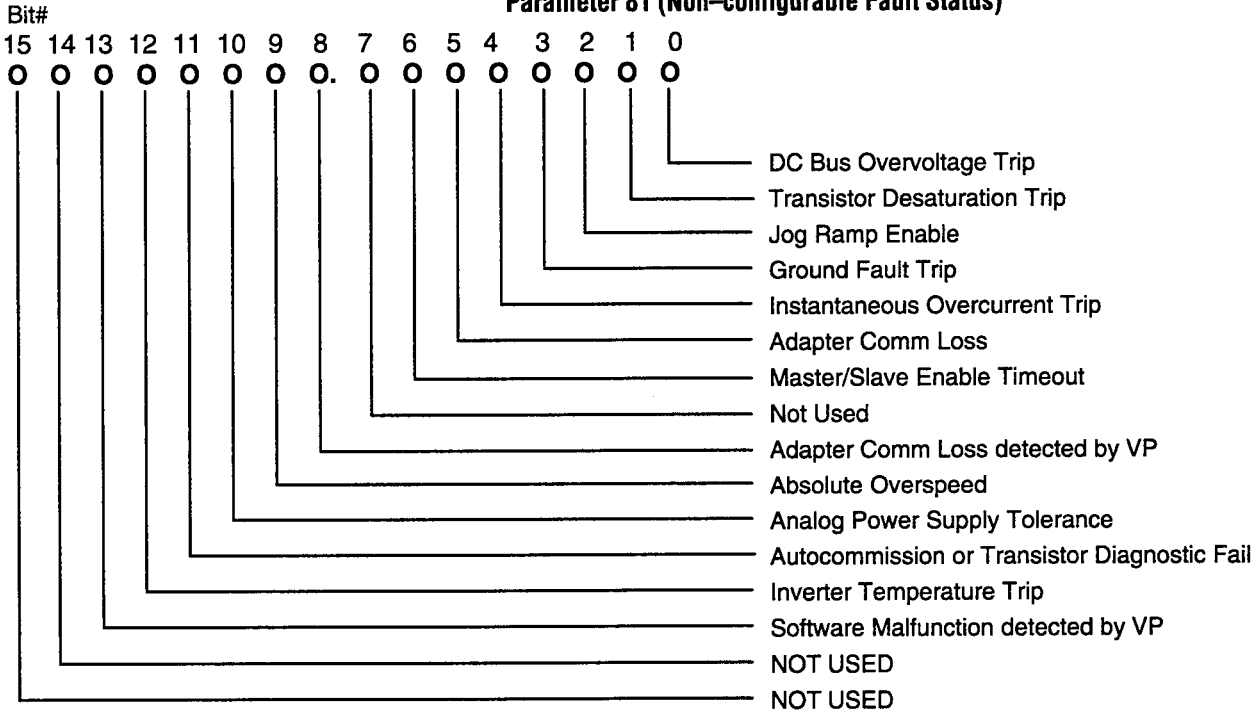

This word parameter indicates fault conditions in the Drive that CANNOT be configured as warnings. When a bit is set to "1", the corresponding condition in the Drive is true, otherwise the condition is false. Bit 0-3 are detected by hardware and 4-15 are detected by software.

Figure 4.3
Parameter 80 (Powerup/Diagnostic Fault Status)

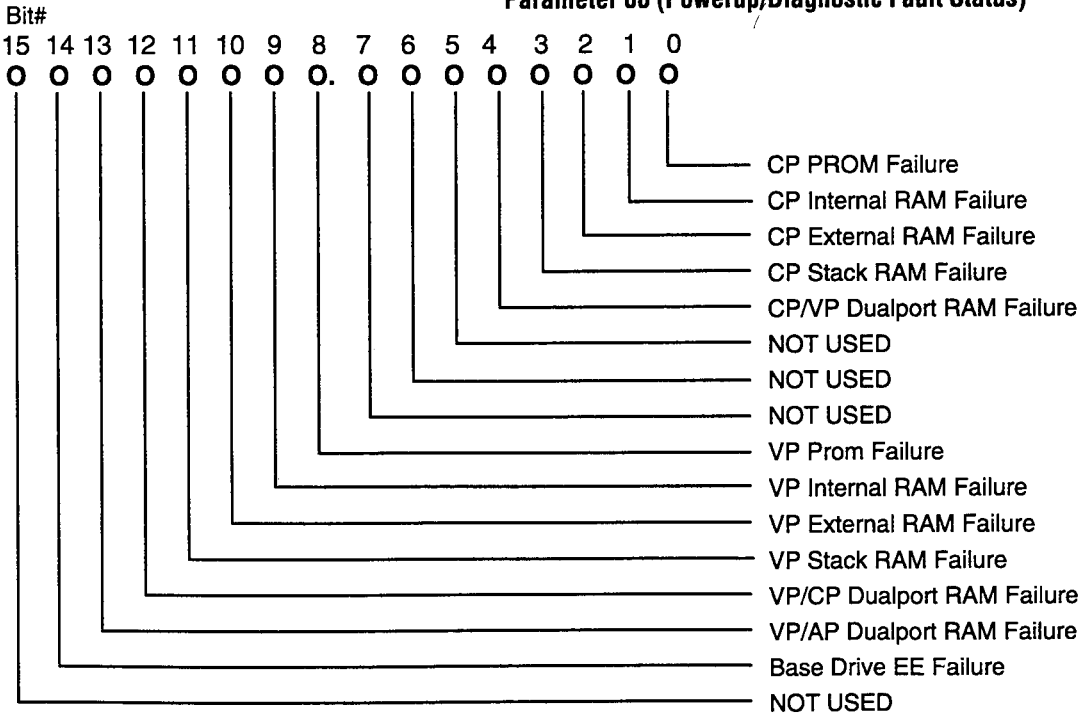

This word parameter indicates a fault condition which has been detected during power up or reset of the the drive. Where the bit is set to "1", the corresponding condition in the Drive is true, otherwise the condition is false.

Current Processor Faults & Warnings – Both the fault and warning queues are configurable for either the Current or the Velocity processor. You can configure which Current processor faults you want to trip the Drive by setting Parameter 86 (Figure 4.4). When the Drive trips on one of the faults set in parameter 86, the CP light on the Motor Control board will turn red. When the drive trips, it will coast the motor to a stop. Parameter 87 (Figure 4.5) has the same bit weights as parameter 86, but instead of tripping, the Drive will display a warning fault, which in turn causes the CP light to flash green, indicating a warning. The Drive will continue to run when there is a CP warning. Parameter 82 (Figure 4.6) displays which CP fault caused the Drive to trip, while parameter 84 displays any CP warnings that have occurred.

Most of the setup for the current processor Fault/Warning configuration deals with DC Bus conditions. These Bus conditions deal with the Bus precharge and any type of ride through conditions.

The Precharge and Ride Through functions are configured through parameter 223 (Precharge/Ridethrough Selection). This parameter is bit encoded as follows:

PRECHARGE/RIDETHRU SELECTION PARAMETER 223

Bit 12	Set	Enables	Precharge as a Common Bus Inverter
Bit 13	Set	Disables	Bus precharge timeout and undervoltage faults while the drive is DISABLED (in HOME state)
Bit 14	Set	Disables	Disables
Bit 15	Set	Disables	Disables

PRECHARGE/RIDETHRU FAULT/WARNING SETPOINTS:

Undervoltage Setpoint	Parameter 224	Scaled in volts
Bus Precharge Timeout	Parameter 225	Scaled for seconds x 10
Bus Ridethru Timeout	Parameter 226	Scaled for seconds x 1000

PRECHARGE and RIDETHRU FAULTS:

The precharge and Ride Through faults are configured through parameters 86 & 87 CP Fault/Warning Configuration Select) as shown in Figures 4.4 and 4.5. To assist in determining the precharge and ride through operating modes software test point #27 (dRam_bus_status) gives the present operating conditions. The test point is bit encoded as follows:

dRam Bus Status SOFTWARE TESTPOINT #27

Bit 0	Set	Indicates	Precharge has been completed
Bit 1	Set	Indicates	Drive is in ride through
Bit 2	Set	Indicates	Precharge initiated by ride through
Bit 3	Set	Indicates	Not Used
Bit 4	Set	Indicates	AC Line Status (valid only while in precharge)
Bit 5	Set	Indicates	Bus rising or falling (valid only while in precharge)
Bit 6	Set	Indicates	Low Bus Cap voltage: small drives only (valid only while in precharge)
Bit 7	Set	Indicates	Precharge cannot be completed because bus is too low compared to the initial bus voltage at power up.

The software test point can be monitored by first entering the dRam_bus_status number (#27) into the Test point selection parameter (e.g. #273). Then the data can be viewed in the corresponding Test point data parameter (e.g. #274).

Figure 4.4
Parameter 86 (CP Fault/Warning Configuration Select (bits))

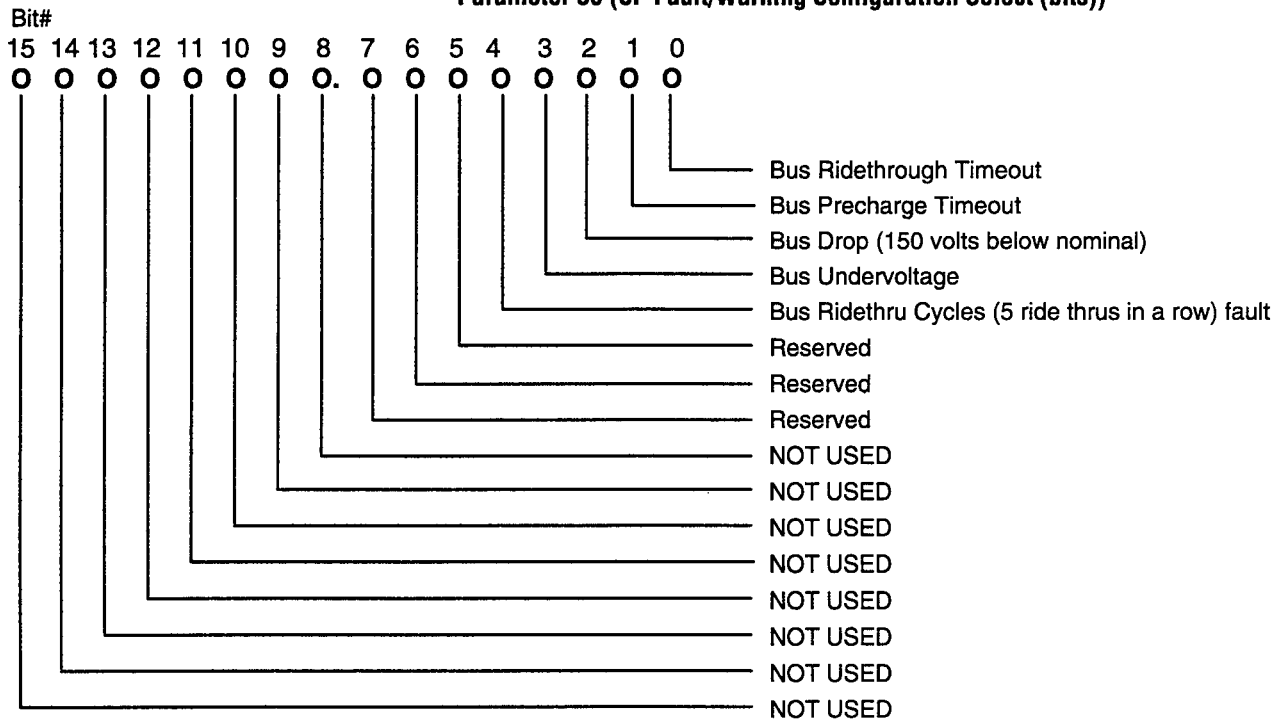

This word parameter determines conditions detected by the Current Processor (CP) that will be reported as either a drive fault or drive warning condition. Each configuration bit matches the bit definitions of Parameters 82, 84 and 87. When a bit is set to "1", the corresponding condition in the Drive will be reported as a FAULT, otherwise the condition is reported as a WARNING.

Figure 4.5
Parameter 87 (CP Warning/None Configuration Select (bits))

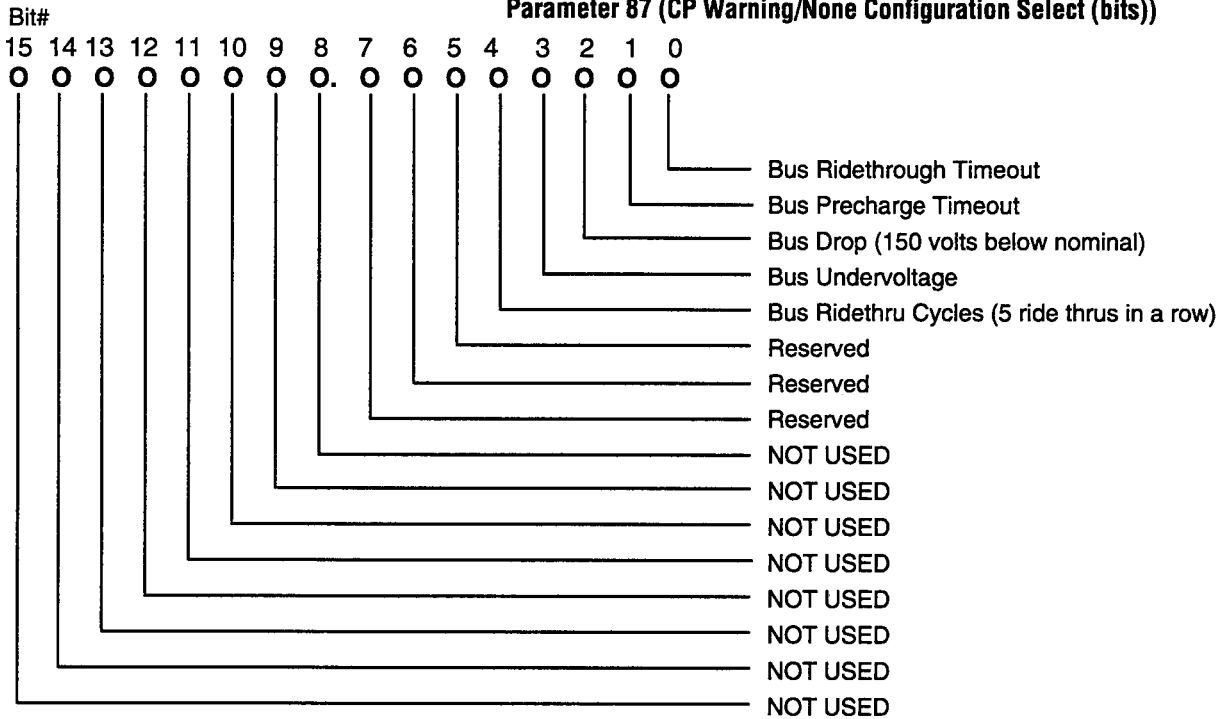

This word parameter determines conditions detected by the Current Processor (CP) that will be reported as either a drive fault or drive warning or not reported at all (ignored). Each configuration bit matches the bit definitions of Parameters 82, 84 and 86. When a bit is set to "1", the corresponding condition in the Drive will be reported as configured by parameter 86. If the bit is set to "0", the condition is not reported.

Figure 4.6
Parameter 82 (CP Configurable Fault Status)

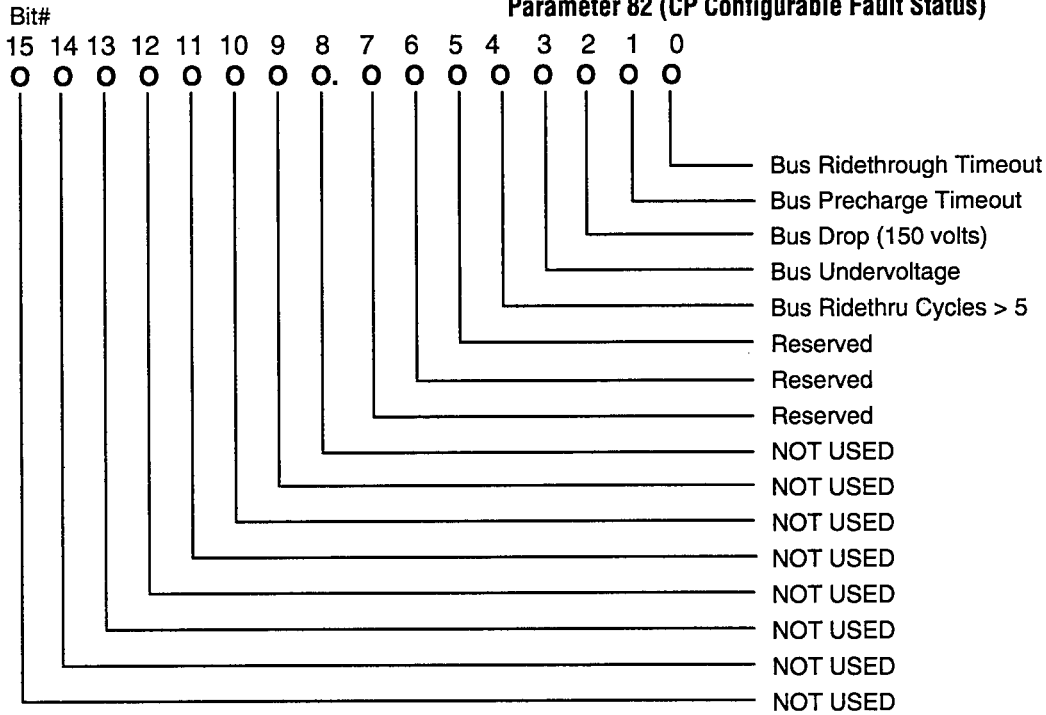

This word parameter indicates conditions detected by the Current Processor (CP) that have been configured to report as a Drive fault condition. Each configuration bit matches the bit definitions of parameters 84, 86 and 87. When a bit is set to "1", the corresponding condition in the Drive is true, otherwise the condition is false.

Figure 4.7
Parameter 84 (CP Configurable Warning Status (bits))

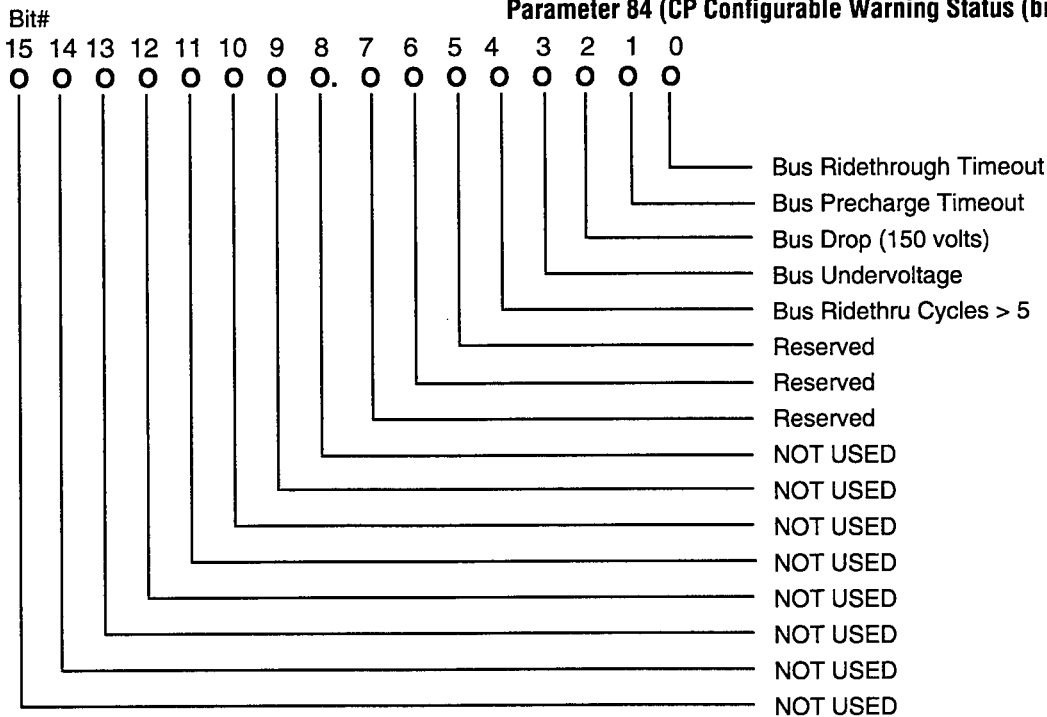

This word parameter indicates conditions detected by the Current Processor (CP) that have been configured to report as a Drive warning condition. Each configuration bit matches the bit definitions of parameters 82, 86 and 87. When a bit is set to "1", the corresponding condition in the Drive is true, otherwise the condition is false.

Velocity Processor Faults & Warnings – You can configure which velocity processor faults you want to trip the drive by setting Parameter 88 (Figure 4.8). When there is a velocity processor fault, the VP light on the motor control board will blink red (soft fault) for configurable VP faults. When this happens, the drive will shut off and coast the motor to a stop. VP faults can be viewed in parameter 83 (Figure 4.9). Configurable VP warnings can be setup in Parameter 89 (Figure 4.10) and viewed in parameter 85. When a configurable VP warning exists, the VP light will be flashing green, but the drive will continue to run. Velocity processor warning faults can be viewed in parameter 85 (Figure 4.11).

Figure 4.8
Parameter 88 (VP Fault/Warning Configuration Select (bits))

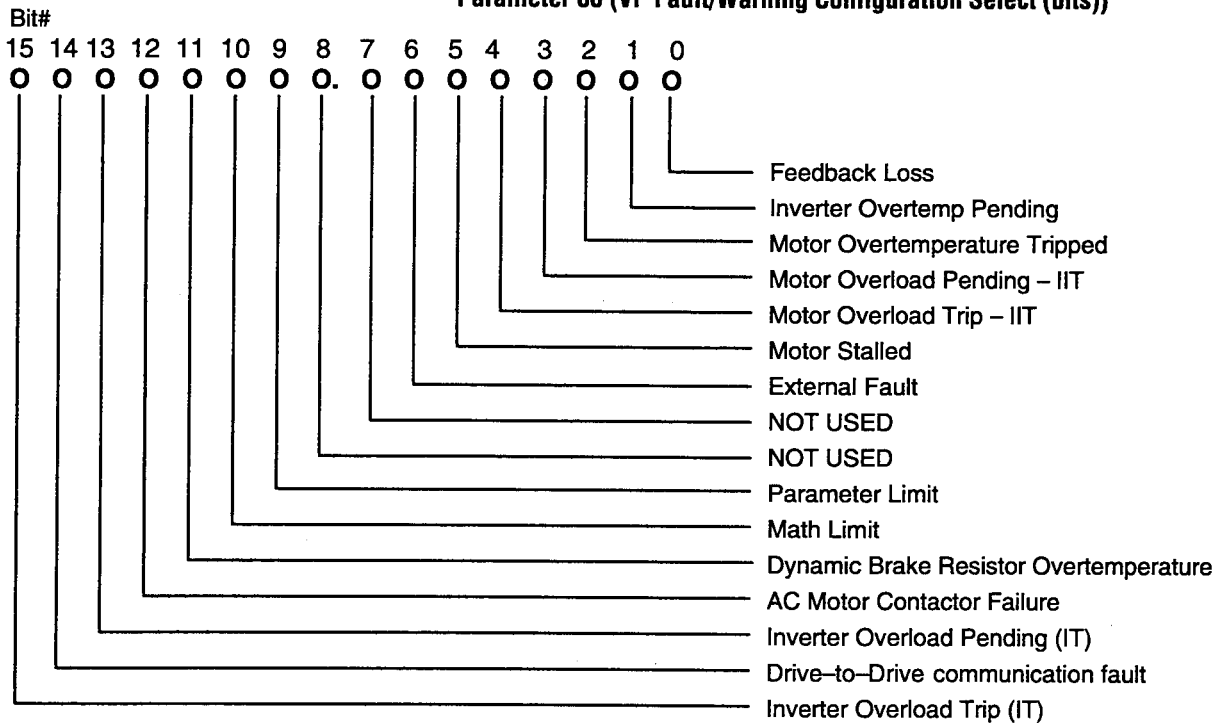

This word parameter indicates conditions detected by the Velocity Processor (VP) that have been configured to report as a Drive warning condition. Each configuration bit matches the bit definitions of Parameters 83, 85 and 89. When a bit is set to "1", the corresponding condition in the Drive will be reported as a FAULT, otherwise the condition is reported as a WARNING.

Figure 4.9
Parameter 83 (CP Configurable Fault Status)

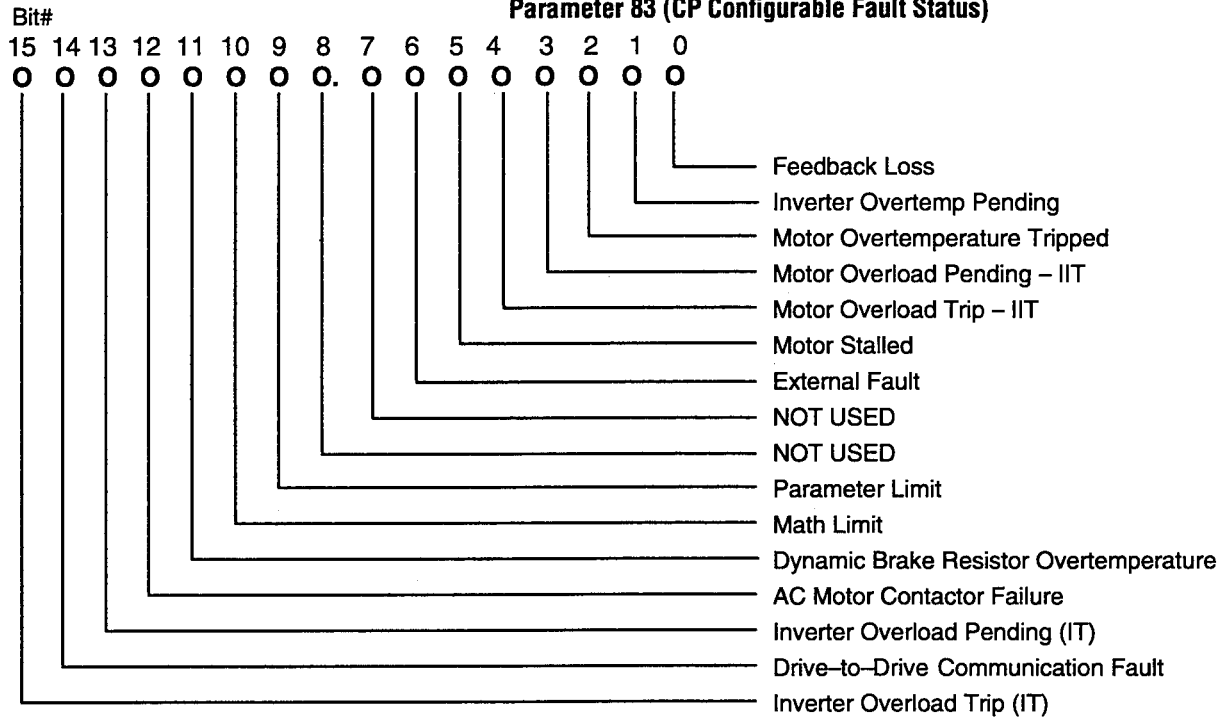

This word parameter indicates conditions detected by the Velocity Processor (VP) that have been configured to report as a Drive fault condition. Each configuration bit matches the bit definitions of Parameters 85, 88 and 89. When a bit is set to "1", the corresponding condition in the Drive is true, otherwise the condition is false.

Figure 4.10
Parameter 89 (VP Warning/None Configuration Select (bits))

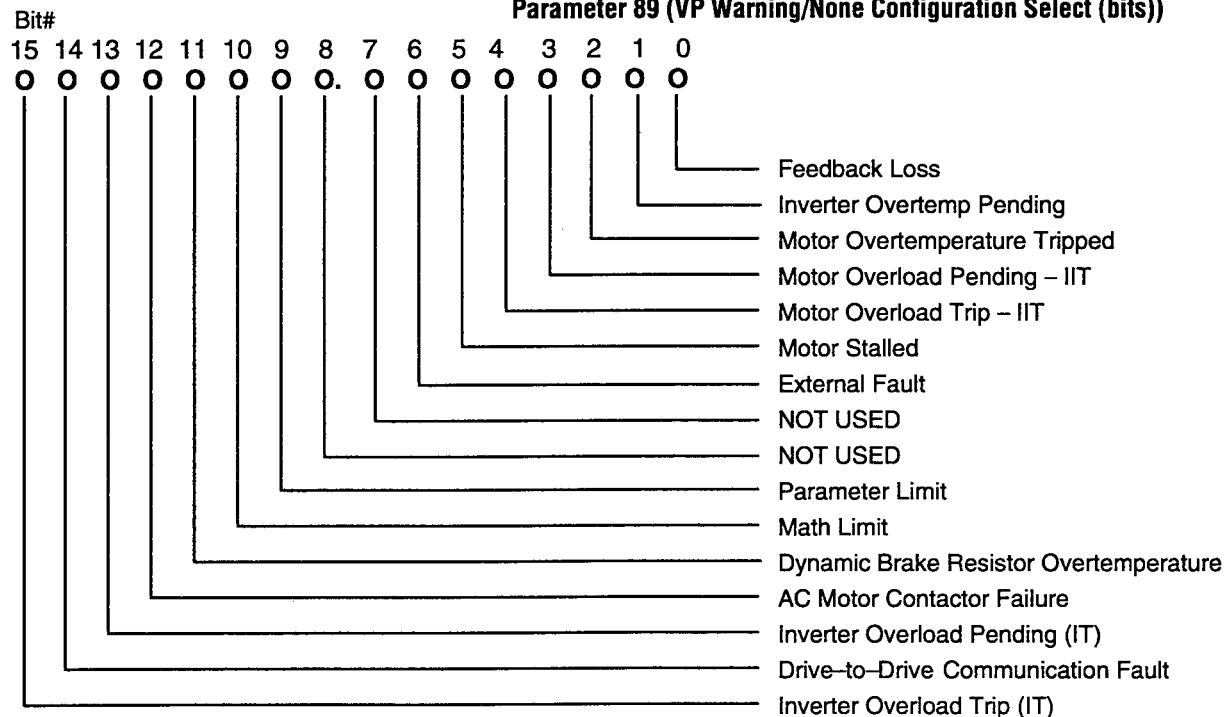

This word parameter indicates conditions detected by the Velocity Processor (VP) that will be reported as either a drive fault or warning or not reported at all (ignored). Each configuration bit matches the bit definitions of Parameters 83, 85 and 88. When a bit is set to "1", the corresponding condition in the Drive will be reported as configured by parameter 88. When the bit is set to "0", the condition is not reported.

Figure 4.11
Parameter 85 (VP Configurable Warning Status (bits))

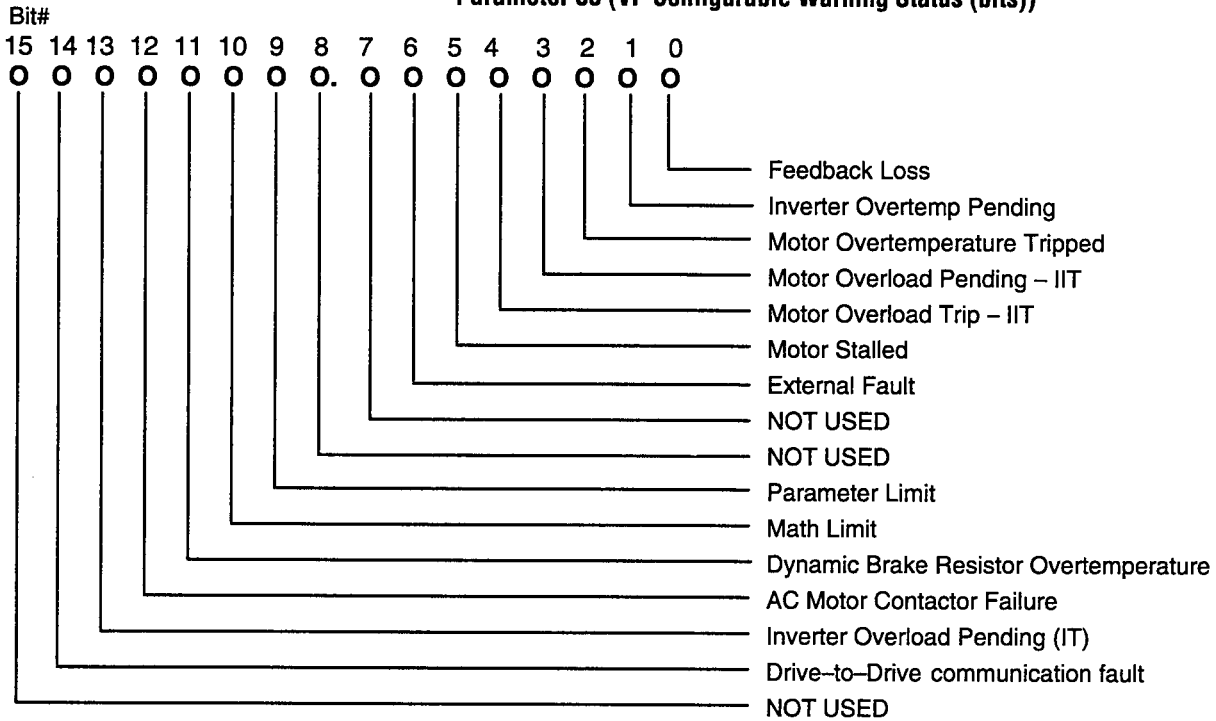

This word parameter indicates conditions detected by the Velocity Processor (VP) that have been configured to report as a Drive warning condition. Each configuration bit matches the bit definitions of Parameters 83, 88 and 89. When a bit is set to “1”, the corresponding condition in the Drive is true, otherwise the condition is false.

Auto-Commissioning Test Procedure Auto-Commissioning is a procedure which involves the running of a group of tests on the motor/drive combination. Some of these tests check the Drive hardware and others configure Drive parameters for torque control with the attached motor.



ATTENTION: Power must be applied to the Drive and the motor must be connected for some of the following tests. Some of the voltages present are at incoming line potential. To avoid electrical shock hazard or damage to equipment, only qualified service personnel should perform the following procedures.

Test Overview: Auto-Commissioning includes 6 tests, all of which can be performed on a motor which is either coupled or decoupled from load. These tests include:

1. ***Power Structure and Transistor Diagnostics:*** These routines allow you to determine if any problems exist in the power structure of the drive and to determine the probable cause of these problems.

The diagnostic software determines hardware problems through a series of system tests. These tests are parameter dependent with the test results dependent on Drive size, motor size, system wiring and other factors that affect system voltage and load impedance.

In most cases, the software can properly determine if faults exist, however there may be some installations where some faults cannot be properly checked. In general, test results are listed as failed if a questionable case is found. You must review test results with respect to the whole drive system for proper interpretation of whether a real problem does exist.

The transistor diagnostics can be enabled to run before a start, or the diagnostics can be run independently by configuring the commissioning routines. Bits 6, 7 and 8 of parameter 59 (Logic Options) enables Transistor Diagnostics. Transistor Diagnostics requires current running thru the motor, so a user enable transistion is required to run the tests in all cases. Transistor diagnostics options are listed in Figure 4.2.

Figure 4.12
Parameter 59 (Logic Options)

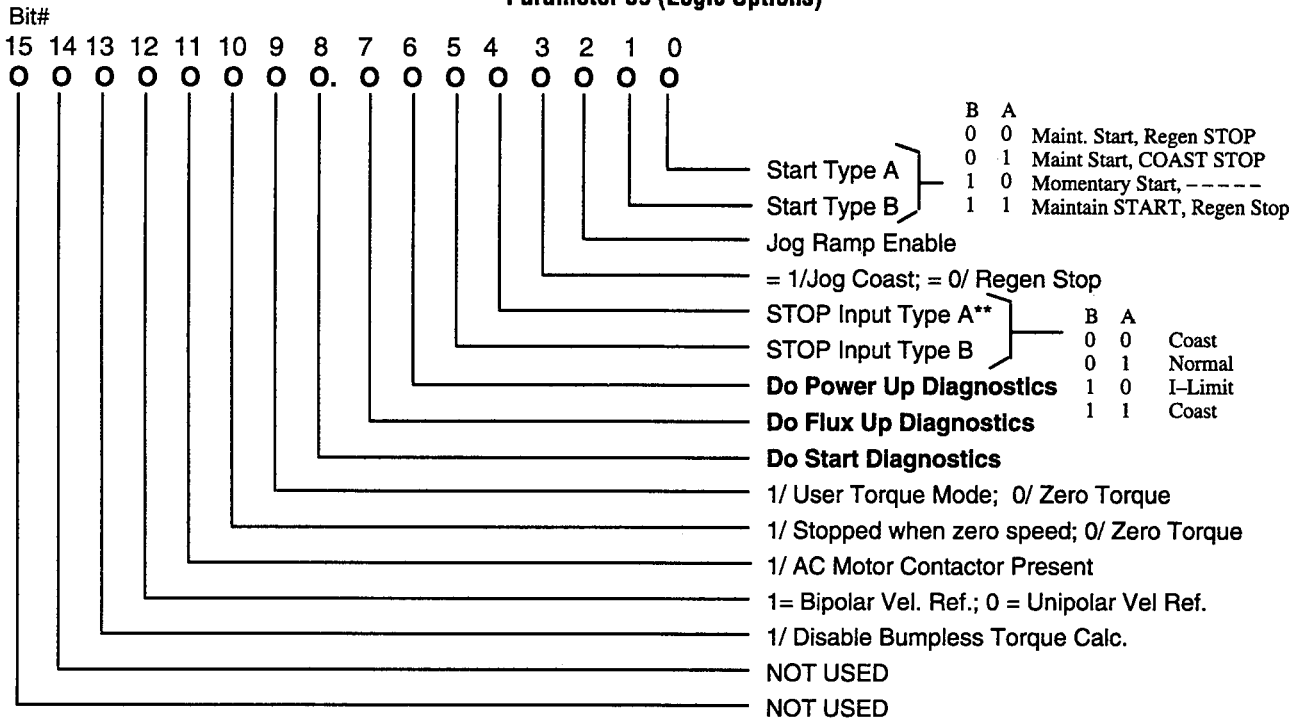

Setting bit 6 of Parameter 59 will run Diagnostics *once* after the first power up and enable.

Setting bit 7 of Parameter 59 will run Diagnostics before each flux up of the motor.

Setting bit 8 of Parameter 59 will run Diagnostics before each start of the drive.

To run the Transistor Diagnostics independently use the Autotune/Diagnostics Selection parameter 256, and set bit 0 to a value of 1. Toggle the Start bit in the logic command. The green Enable light (D21 on PLC Comm Board) will turn on briefly and then turn off. This will run only the transistor diagnostics and leave the drive disabled after the diagnostics have completed. Parameter 256 will be automatically set to zero after the diagnostics have run.

Since these test results are system dependent, you have the option of disabling tests that may give questionable or nuisance faults. The tests are disabled through parameter 257 (Transistor Diagnostics Configuration) as shown in Figure 4.13.

Figure 4.13
Parameter 257 (Transistor Diagnostics Configuration)

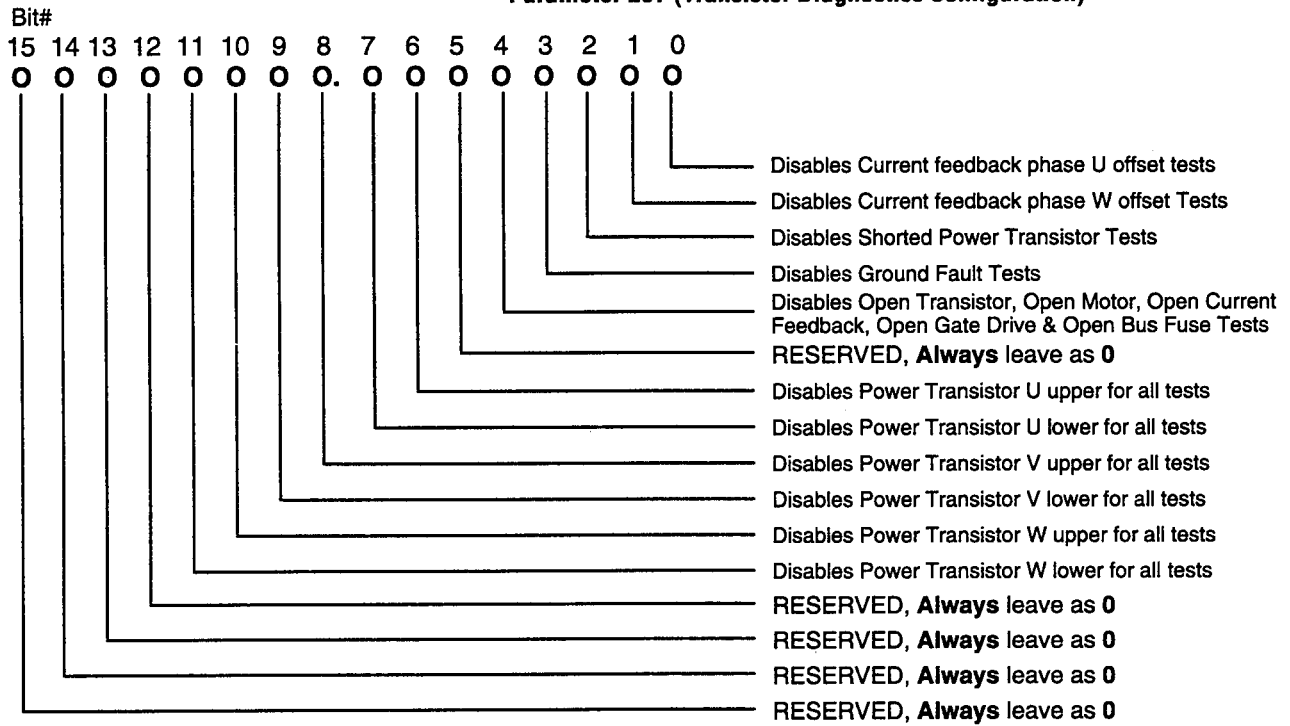

The disabling of individual transistors or any combination of transistors is available for specific module testing in the power structure. You must leave all transistors enabled under most conditions.

The results of the transistor diagnostic tests are given in parameters 258, 259 and in software test point #27. Each of the results is bit encoded as shown in Figure 4.14 and 4.15.

Figure 4.14
Parameter 258 (Inverter Diagnostics Result #1)

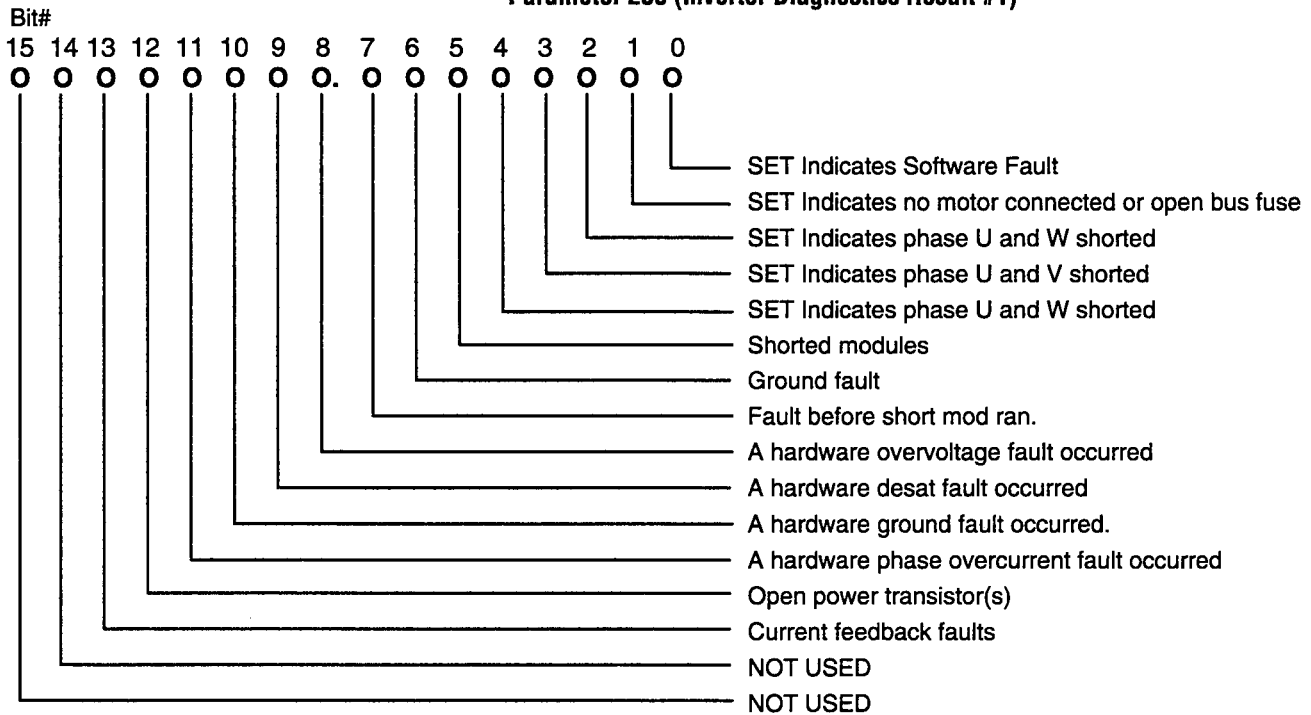
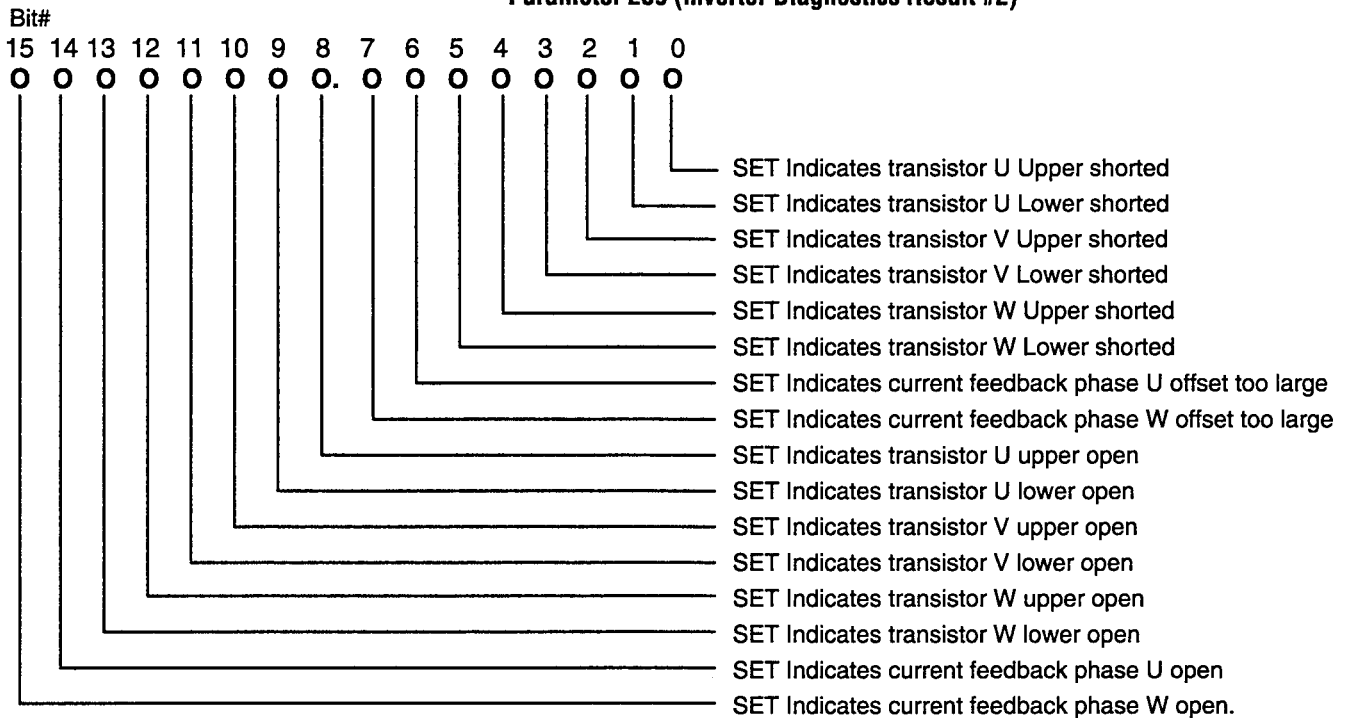

Figure 4.15
Parameter 259 (Inverter Diagnostics Result #2)



If any hardware fault occurs during the open transistor testing, the hardware fault is saved and a Phase to Phase fault is set. All subsequent testing is stopped and some untested devices may be set as open. Typically the hardware fault should be fixed and then open tests rerun to determine if any opens exist.

Open Transistor Faults – Open transistor faults could indicate an open anywhere in the control or power section that turns on a given transistor. The power transistor gate drive signal should be checked from the control board through the cabling to the opto-isolators continuing through the gate drives and finally through the cabling to the power transistor. This includes the power wiring to the motor terminals and the motor. You should also note that if the Bus voltage is too low, opens could occur (Bus voltage should be greater than 85% of nominal line).

Multiple Opens – If there are multiple opens, it is possible that several additional faults may be indicated. For example; If transistor U upper AND U lower are open the test will also indicate that current feedback U phase is open. Since there is no way of running current through phase U, the current feedback device cannot be checked and therefore is listed as failed. Contact A–B Support Services if problems with the U phase are suspected. The type of installation often determines which parts of the transistor diagnostics may or may not work. As a result, the software should be treated only as an aid for testing the power structure.

Nuisance Faults – If a software fault occurs, it usually indicates that an improper sequence of events has occurred. Either the software is unable to distinguish what is occurring, or there is noise in the system. Normally a software error would be an indication that the test should be rerun. In cases of repeated faults, it may indicate a fault that cannot be directly identified (for example, a voltage breakdown in a snubber.) At this point you will have to determine through external measurements if the problem is real or if there is a noise problem. In cases where a specific test continually results in nuisance faults, that test can be disabled.

Test Points – Software testpoint #28 (Fig.4.16) can give an indication of which software routine was running when a fault occurred and which hardware fault occurred during the test. The software testpoint can be examined by entering the test point number (#28) into a test point selection parameter (e.g. parameter 273). The test point data can then be viewed in the associated parameter (e.g. 274).

Figure 4.16
Software test point #28 sw_fault

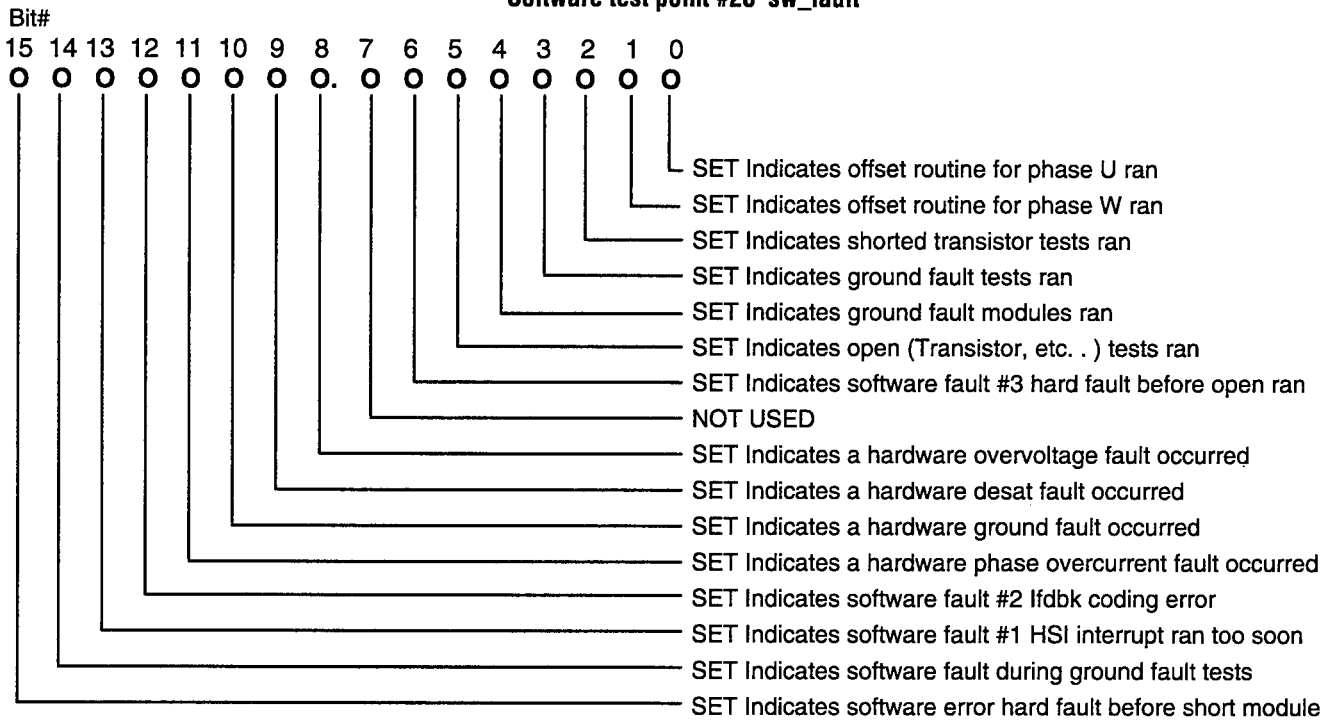

Software Testpoint #29 (td_sm_counter) lists the last test run before transistor diagnostics stopped as follow:

- 0 => initialization
- 1 => LEM U
- 2 => LEM W
- 3 – 8 => shorted transistor tests Utop, bot then Vtop, bot then Wtop, bot
- 9 => tests stopped on fault
- 10 – 15 => Shorted transistor tests Utop, bot then Vtop, bot then Wtop, bot
- 16 => tests stopped on fault
- 17 => Conduction U > W LEM U
- 18 => Conduction U > W LEM W
- 19 => Conduction W > U LEM U
- 20 => Conduction W > U LEM W
- 21 => Conduction U > V LEM U
- 22 => Conduction V > U LEM U
- 23 => Conduction W > V LEM W
- 24 => Conduction V > W LEM W
- 25 => Done

Software Testpoint #30 lists the average on time measured in the last test.

NOTE: The transistor diagnostics **CANNOT** be run through parameter 59 (logic options) in any master–slave drive operation.

Since the routines of the two drives may give incorrect results when running together, these options are disabled for all master-slave drives. The only way to start transistor diagnostics is to run each Drive through parameter 256 individually.

2. **Phase Rotation:** For proper drive operation it is necessary to have:
 - A. A specific phase sequence of the motor leads (M1 M2 M3, M1 M3 M2 etc.)
 - B. A specific sequence of encoder leads (pulse A leads B etc.)These sequences determine the direction of rotation of the motor shaft on application of torque. An improper sequence can result in either the motor spinning the wrong direction or no production of torque. This test is used to ensure the above conditions by applying a positive torque and manually checking motor rotation and velocity feedback.
3. **Sequential Torque Block Tuning:** Set parameter 256 Bit 2 to a value of 1.

A. Inductance Test: Motor inductance is required to determine the references for the regulators that control torque. This test measures the motor inductance and displays it in **Parameter 237**. The motor should not rotate during this test although rated voltages and currents are present and the possibility of rotation exists.

Toggle the Start bit in the logic command to start the test. The Drive enable light will go out when the test is complete. It runs for approximately 1 minute. When a reading is obtained in Parameter 237, record it and then perform the resistance test. If the test still faults, refer to inductance test faults

Inductance Test Faults – Motor inductance is required to determine the references for the regulators that control torque. This test measures the motor inductance and displays it in Parameter 237.

The motor must not rotate during this test.

Typical values for per unit inductance are in the range of 15% to 25% motor impedance. The value in Parameter 237 reads in percent. If long wiring runs are used, the typical value should increase by the ratio of wiring inductance to motor inductance.

Several special faults have been added to the motor inductance measuring routine. Should the drive trip while the inductance test is being run, the reason for the trip can be found by using a software testpoint. Place a value of 47 into Parameter #273 (Testpoint Selection #1) and then go to Parameter #274 to look at the results. The possible faults are detailed in Table 4.D.

Table 4.D
Inductance Test Fault Descriptions

Displayed Value	Fault
1	Motor Not at Zero Speed
2	Sign Error
3	Motor Not at Zero Speed & Sign Error
4	Zero Current
5	Motor not at Zero Speed & Zero Current
6	Sign error & Zero Current
7	Motor Not at Zero Speed, Sign Error & Zero Current.

Responses for faults:

Motor Not At Zero Speed: If the motor is rotating during this test a improper result is likely. Make sure the motor is not rotating just prior to the test, or during the test. If this fault still occurs with no motor rotation present then investigate electrical noise creating encoder transitions. Noise could be caused by improper encoder grounding or noisy encoder power supply.

Sign Error: If the average voltage is negative, a sign error fault is generated. The value obtained with a sign error is usually an improper result. Consider running the test again.

Zero Current: If the rated motor current is set to zero the zero current fault is generated. Set the rated motor current to the correct value and run again.

B. Resistance Test: Motor resistance is required to determine the references for the regulators that control torque. Set **Parameter 256** Bit 3 to a value of 1. This selects Motor Flux Test. This test measures the motor resistance and displays it in Parameter 236. The motor will not rotate during this test, although rated voltages and currents are present and the possibility of rotation exists. The test runs for approximately 10 seconds.

Toggle the start bit in the logic command to start the test. The Drive Enable light will go out when the test is complete. When a reading is obtained in parameter 236, record it and perform the flux test. If the test still faults, refer to resistance test faults.

Resistance Test Faults: Motor resistance is required to determine the references for the regulators that control torque. This test measures the motor resistance and displays it in **Parameter 236**.

Typical values for per unit motor resistance are in the range of 1% to 3% as displayed in Parameter 236. The value in Parm 236 will increase as the length of wiring runs increase.

Several faults have been included to identify some problems that can occur in the resistance measuring routine. Should the drive trip while the resistance test is being run, the cause can be found using a software testpoint. Place a value of 46 into Parameter #273 (Testpoint Selection #1) and then go to Parameter #274 (Testpoint Data #1) to look at the results. The possible faults are detailed in Table 4.E.

Table 4.E
Resistance Test Fault Descriptions

Displayed Value	Fault
1	Motor Not at Zero Speed
2	Sign Error
3	Motor Not at Zero Speed & Sign Error
4	Not Used
5	Not Used
6	Not Used
7	Not Used
8	Zero Current
11	Motor not at Zero Speed, Sign Error & Zero Current
32	Software Error
33	Motor not at Zero Speed, Software error
34	Sign Error, Software Error
35	Motor Not at Zero Speed, Sign Error & Software error
53	Motor Not at Zero Speed, Sign Error, Zero Current & Software Error

Responses for faults:

Motor Not At Zero Speed: If the motor is rotating during this test an improper answer is likely. Make sure the motor is not rotating just prior to the test, or during the test. If this fault still occurs with no motor rotation present then investigate electrical noise creating encoder transitions. Noise could be caused by improper encoder grounding or by a noisy encoder power supply.

Sign Error: If the average voltage is negative, a sign error fault is generated. The value obtained with a sign error is usually an improper answer. Consider running the test again.

Zero Current: If the rated motor current is set to zero the zero current fault is generated. Set the rated motor current to the correct value and run again.

Software Error: A software fault is generated when an improper sequence of events has occurred. Consider running the test again.

C. Flux Test: Rated motor flux is required in order to produce rated torque at rated current. Set **Parameter 256** Bit 4 to a value of 1. This selects the Motor Flux Test. This test measures the amount of current required to produce rated motor flux and displays it in **Parameter 238**. The motor will accelerate to approximately base speed and then coast for several seconds. This cycle may repeat several times. The motor will then decelerate to a low speed before disabling. If the motor will not accelerate; increase parameter 40 (Torque Limit) until the motor accelerates. Parameter 41 (Speed Limit) will change the speed the motor accelerates to.

The Phase Rotation, Inductance and Resistance Tests MUST be run before this test can be performed!

Toggle the start bit in the logic command to start the test. The Drive enable light will go out when the test is complete. When a reading is obtained in **Parameter 238**, record it and then update the torque block gains. If the test still faults, refer to the flux test faults.

Flux Test Faults: Rated motor flux is required in order to produce rated torque at rated current. This test measures the amount of current required to produce rated motor flux and displays it in Parameter 238. The motor will accelerate to approximately base speed and then coast for several seconds. This cycle may repeat several times. The motor will then decelerate to a low speed before disabling.

ATTENTION: Both the Inductance Test and Resistance Tests must be run before running the Flux Test.

Typical values for rated motor flux range from 20% to 50%. Several faults have been added to identify some problems that can occur in the flux test. Should the drive trip while the flux test is being performed, the cause can be found using a Software Testpoint. Place a value of 48 into Parameter #273 (Testpoint Selection #1) and then go to Parameter #274 (Testpoint Data #1) to look at the results. The possible faults are detailed in Table 4.F.

Table 4.F
Flux Test Fault Descriptions

Displayed Value	Fault
1	Parameter 41 set to less than 33% speed
2	Parm 238 < 0 Current
3	Parm 41 set to less than 33% speed & Parm 238 < 0 Current
4	Parm 238 > 100% Drive current
5	Parm 41 set to less than 33% speed & Parm 238 > 100% Drive Current
6	Not Used
7	Not Used

Responses for faults:

Parm 41 set to less than 33% speed: The Autotune speed must be set higher in order to get a meaningful result out of the flux test.

Parm 238 < 0 Current: This indicates that either 1 or some of the parameters are incorrectly set, electrical noise is/was present, motor phasing could be incorrect or other problems exist.

Parm 238 > 100% Drive Current: This identifies flux current greater than the drive rated current. This may be due to incorrect parameter settings, an undersized drive for the motor, or a problem motor.

If you experience problems while running the Flux Test it may be necessary to verify that parameters are set properly. The parameters listed in Table 4.G are the parameters that directly effect the Flux Test.

**Table 4.G
Flux Test Parameters**

Parameter Number	Description	Value/Comments
40	Autotune Torque Limit	100% allows 1 p.u. torque during accel
41	Autotune Speed	+/- 68% is the max. for the flux test, limited internally by the software.
127	Reverse Speed Limit	Set this to the limit of the application, if set to 0, the motor may not accelerate.
128	Forward Speed Limit	Set this to the limit of the application, if set to 0, the motor may not accelerate.
175	Positive Torque Ref Limit	Set this to the limit of the application, if set too low, the motor may not accelerate.
176	Negative Torque Ref Limit	Set this to the limit of the application, if set too low, the motor may not accelerate.
177	Motoring Power Limit	Set this to the limit of the application, if set too low, the motor may not accelerate.
178	Regen Power Limit	If set too high, you may trip out on a Bus Overvolts (see note).
179	Positive Motor Current Ref Limit	Set this to the limit of the application, if set too low, the motor may not accelerate.
180	Negative Motor Current Ref Limit	Set this to the limit of the application, if set too low, the motor may not accelerate.
227	Cp Operating Options	Set to 0 to allow the motor to coast to stop once the flux test is completed. Set to 128 to regen to stop even without a brake once the flux test is completed*.

**Note: The option to regen to stop following identification of flux producing current should function properly with or without a brake or regeneration unit. However, if a bus overvoltage fault occurs during the regen to stop, the identified value of flux producing current can be retrieved and placed in P238 without re-running the flux identification test with the regen to stop disabled. The identified value of flux can be found by using Software Testpoint Parameter 273 and placing 58 into it. The value of flux can be read by the user in the corresponding testpoint data parameter #274. The value of 274 is the identified flux current and must then be entered into parameter 238.*

- C. **Torque Block Update:** To update the Torque Block gains, bit 5 in **Parameter 256** must be set to 1, and then a Start command must be given to the drive. Bit 5 of parameter 256 will automatically be set back to zero. The values in parameters 240 thru 248 will now to be updated.
- 4. **Calculations:** This procedure takes the motor parameter information from Parameters 236, 237 and 238 along with the inverter and motor nameplate data and calculates the proper regulator references for torque control (Fig 4.17).

Figure 4.17
Calculations Test

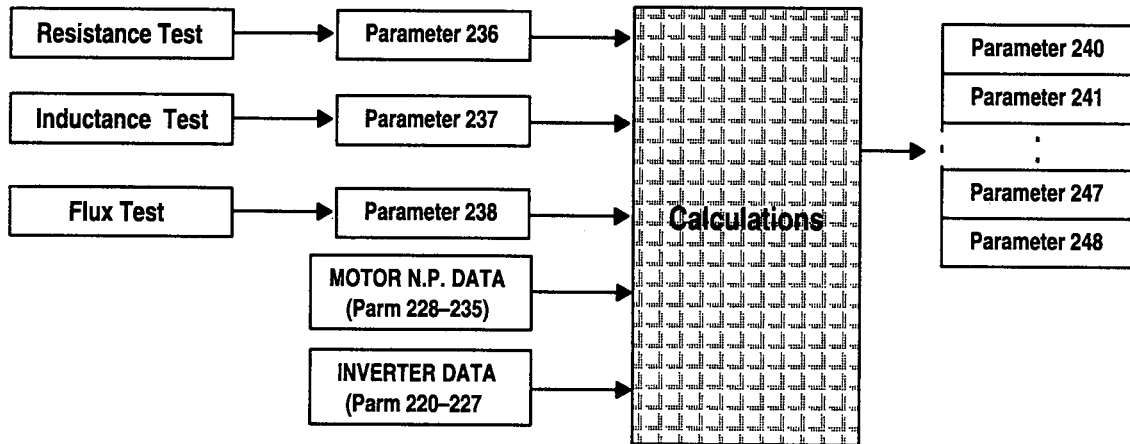

Velocity Loop Autotune

The Velocity Loop Autotune procedure for the 1336 FORCE is designed to let you determine the maximum bandwidth for a particular system. You can select operation at any bandwidth at or below the maximum bandwidth that has been calculated.

The velocity regulator is a PI regulator with a Velocity Feed Forward term (K_F Parm 141). The K_F term is user chosen and describes the system response to a change in velocity reference only. By decreasing the value of K_F the overshoot of the system will be reduced. When K_F is 1.0 the velocity loop behaves like a normal PI loop with the overshoot equaling approximately 10%. If K_F is reduced to 0.7 (the recommended operating point) then the overshoot is typically less than 1%, if K_F is reduced even further to 0.5 (the lowest recommended value) the response becomes underdamped with no overshoot.

The velocity loop KI term (parm 139) is the integral term of the PI regulator. The KI term is adjusted to remove any steady state instabilities.

The velocity loop KP term (Parm 140) is the proportional term of the PI regulator. The KP term is adjusted to determine how the drive responds to a step change in load.

IMPORTANT: If the velocity regulator is tuned too responsive, the motor and load could potentially chatter. If tuned non-responsive, the regulator will seem sluggish. The value for K_p will increase as the system inertia increases. For High inertia systems, K_p may be greater than for KI. For low inertia systems (systems with inertias under 1 Sec.) KI will typically be larger than K_p .

Figure 4.18
Velocity Regulator Functional Diagram

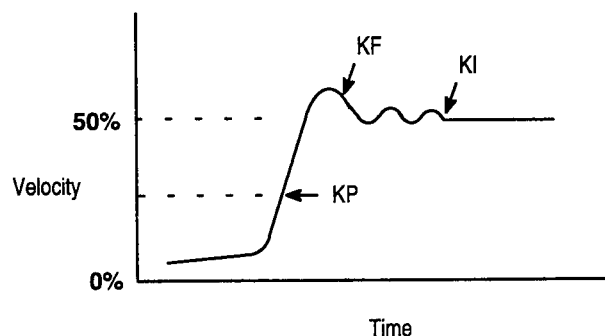

The list of parameters that must be set to achieve proper velocity loop tuning is detailed in Table 4.H.

Table 4.H
Velocity Loop Parameters

Parameter Number	Description	Value/Comments
40	Autotune Torque Limit	75% allows .75 Percent torque during accel
41	Autotune Speed	75% allows Autotune velocity to go to 0.75 Percent velocity
53	Torq Mode Select	Set to Value of 1 for encoder fdbk
127	Reverse Speed Limit	Set this to the limit of the application, if set to 0, the motor may not accelerate.
128	Forward Speed Limit	Set this to the limit of the application, if set to 0, the motor may not accelerate.
150	Feedback Device Type	Set to Value of 1 for encoder fdbk
175	Positive Torque Ref Limit	Set this to the limit of the application, if set too low, the motor may not accelerate.
176	Negative Torque Ref Limit	Set this to the limit of the application, if set too low, the motor may not accelerate.
177	Motoring Power Limit	Set this to the limit of the application, if set too low, the motor may not accelerate.
178	Regen Power Limit	If set too high may trip on a Bus Overvoltage fault.
179	Positive Motor Current Ref Limit	Set this to the limit of the application, if set too low, the motor may not accelerate.
180	Negative Motor Current Ref Limit	Set this to the limit of the application, if set too low, the motor may not accelerate.
235	Encoder PPR	Pulses Per Revolution

Power Device Troubleshooting

Testing power devices is a relatively fundamental procedure that may not be 100% accurate in all cases, but it will give you a good indication as to what components may be good or bad when tracing a problem. These measurements are for individual devices NOT connected within the power structure. The following examples contain typical readings that are received when testing power devices with a digital volt meter. These component tests are for modules found in the 1336 FORCE Drive only. Readings may vary by as much as +/- 30% from the values displayed in the examples when determining whether a part is functional.

Figure 4.19.
3 Phase Diode Bridge Testing

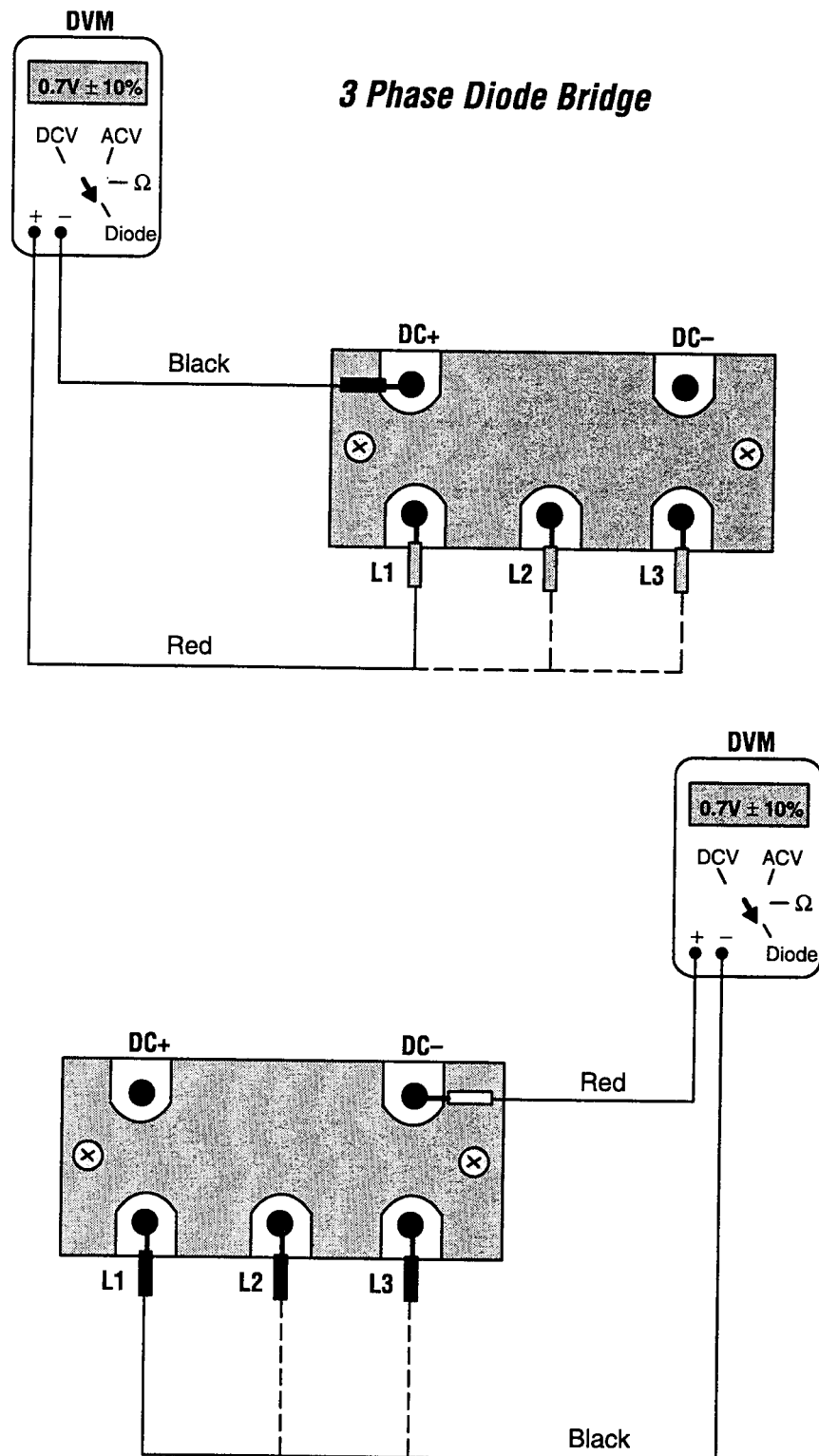

Figure 4.20.
SCR Testing

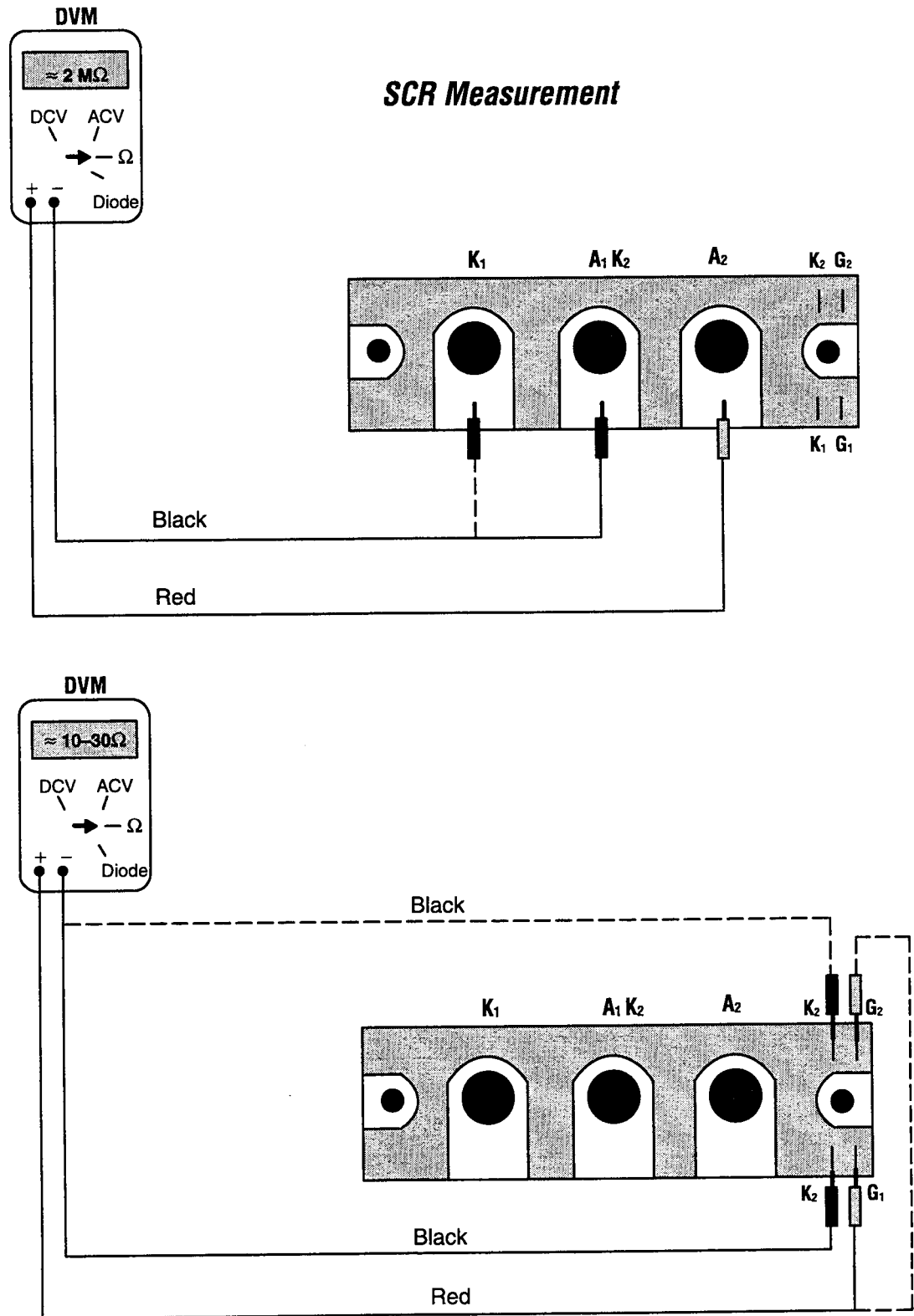

Figure 4.21.
IGBT Module Testing

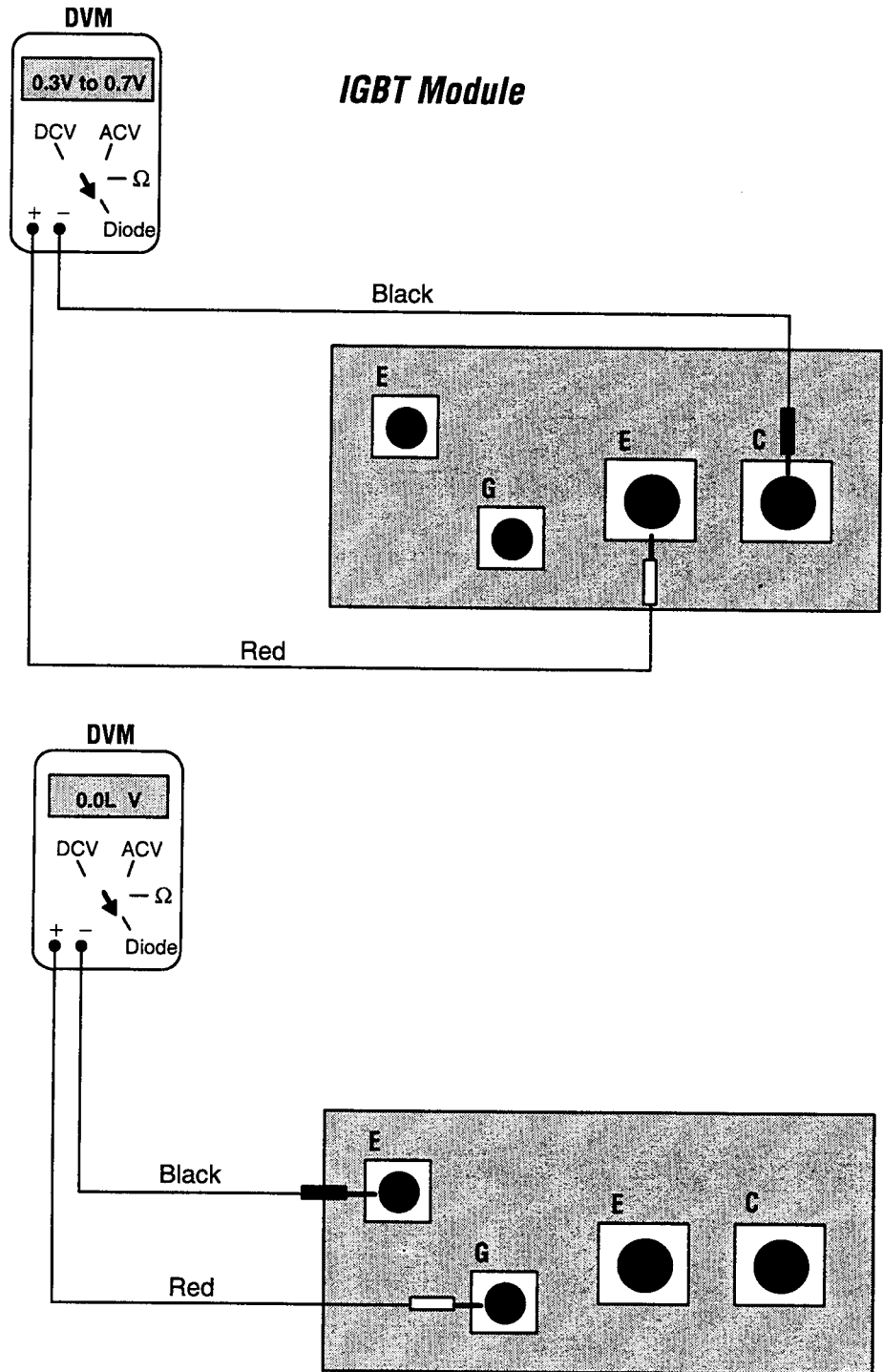

Figure 4.22.
Twin Pack IGBT Testing

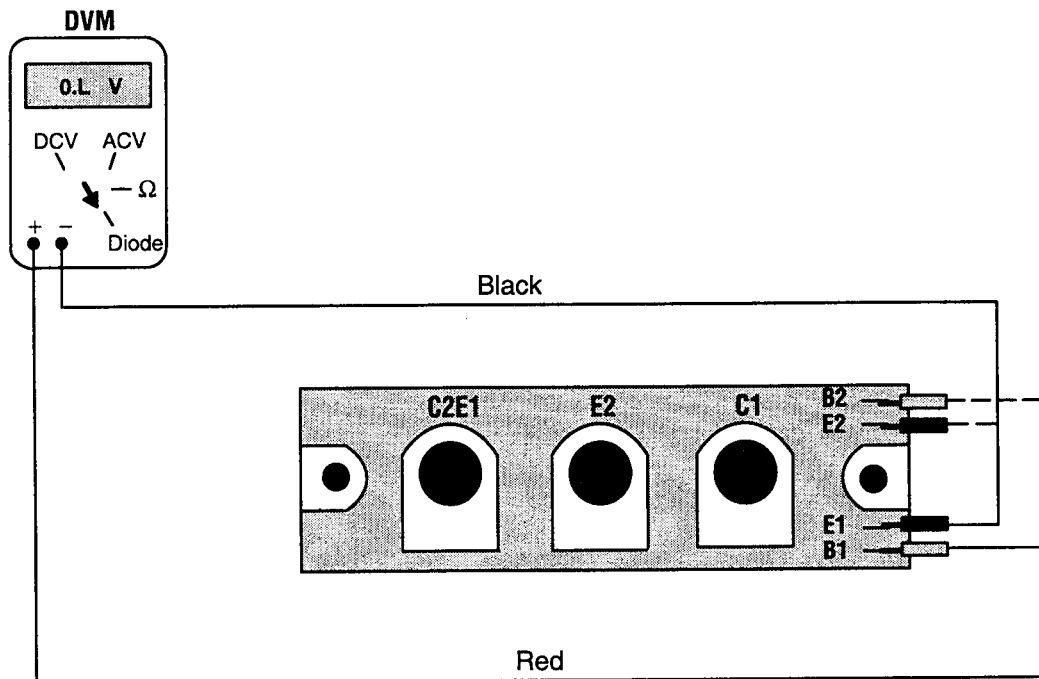
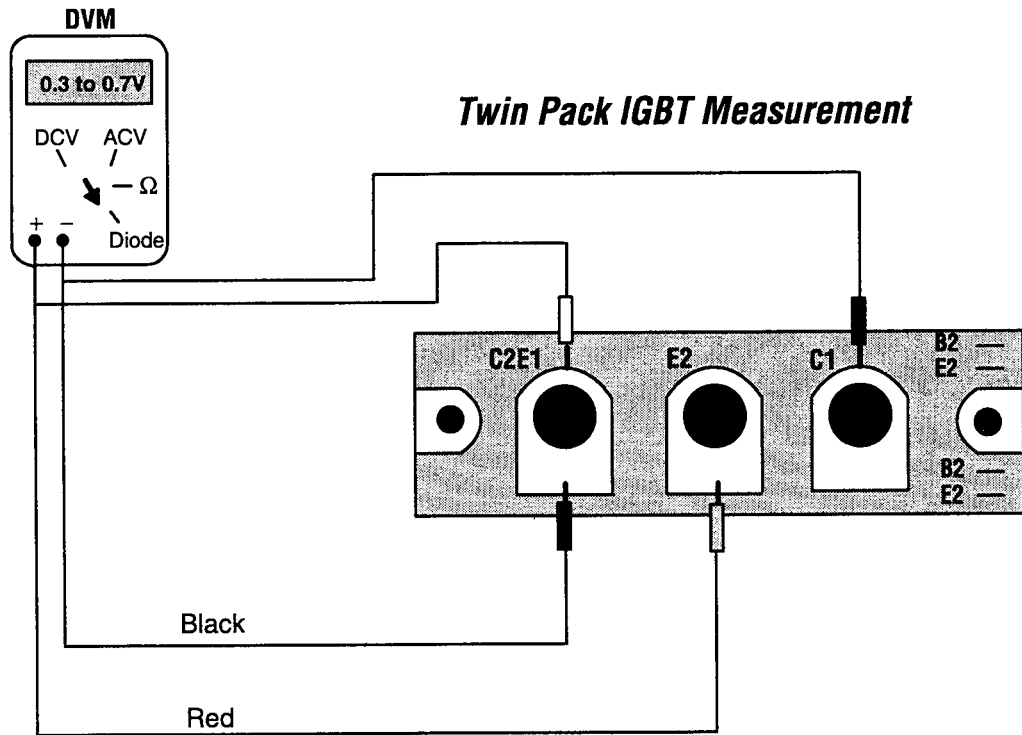
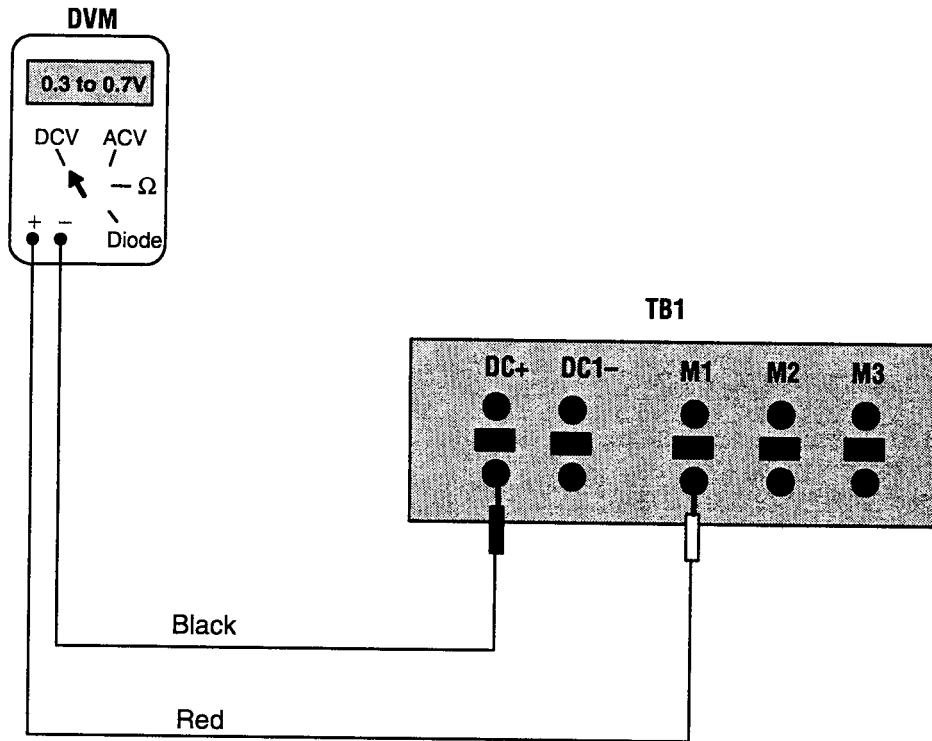

Figure 4.23.
Blown Bus Fuse Test



Programming Parameters

Introduction

This chapter contains the information required to assist the user in programming the 1336 FORCE drive for a specific application after initial start-up. Drives are shipped programmed with default values and are preconfigured for the options installed.

Parameters 0 thru 288 are the parameters for the 1336 FORCE Motor Control Board. Parameters 300 and above cover the Adapter Board of the 1336 FORCE DRIVE. The 1336 FORCE parameters are also divided into the following types:

Basic – Parameters that are available to the user (viewable) when the Drive is in the Basic Mode.

Enhanced – Additional parameters that become available (in addition to the Basic Parameters) when the drive is in the Enhanced Mode.

Parameters are divided into 19 blocks to help ease programming and operator access as follows:

1. System Data Block
2. Drive to Drive Interface Data
3. Process Trim Block
4. Autotune Block
5. Drive Logic Block
6. Dynamic Brake Block
7. Fault Block
8. Velocity Reference Block
9. Velocity Regulator Block
10. Velocity Feedback Block
11. Torque Reference Block
12. Inverter Configuration
13. Motor Nameplate Data
14. Motor Constants
15. Torque Regulator
16. Autotune /Diagnostics
17. Monitor Display
18. Torque Block Testpoint Selection
19. Temporary Block

Terminology

The definition of terms related to the parameter table include:

Configuration – The process of linking Sink to Source parameters.

Configuration Parameters – Parameters used to transfer data between the drive control and external devices. The Configuration Parameters are categorized into two types:

1. Source Parameters – Parameter used as a source of data.
2. Sink Parameters – Parameter used to receive data input.

All parameters in the 1336T can be used for evaluation (sink or source) and some can be modified dynamically (sink only) to meet application requirements.

Drive Units – The actual value of the parameter as it is stored within the Drive parameter table. The drive units may be converted to engineering units or to hexadecimal for display using the Programming Terminal, or may be displayed directly in drive units. All internal values in the drive are in terms of Per Unit numbering.

Engineering Units – A label given to parameter data which specifies what units are to be used to display the parameter value on the Programming Terminal. Examples of engineering units include: RPM, % etc.

Non-Volatile Memory – Data memory in the drive which retains the values of all data even when power is disconnected from the drive control. EEPROM (Electrically Erasable Programmable Read Only Memory) chips are used for the non-volatile memory to store some of the drive parameters.

Parameter Table – Table of parameter entries for all configuration and setup parameters used in the drive.

Parameter Entry – Information stored in the drive which contains the parameter number, parameter data and all other information related to the specific parameter.

Parameter – Memory location used to store drive data. Each parameter is given a number called the parameter number. The parameter value may be specified in decimal, or in hexadecimal. When specified in hexadecimal, the word “Hex” will appear after the parameter value.

Per Unit Numbering – Per Unit numbering is a numbering system which defines a specific numeric value as representing 100% of a particular quantity being measured. The number 4096 is used in many places in the drive to represent 1 Per Unit (100%) [pu].

Parameter Table Structure

All data used to perform the Drive functions is stored in the Parameter Table. Each parameter entry in the parameter table contains the information illustrated in Figure 5.1.

Figure 5.1. Parameter Entry

Parameter Number
Parameter Type
Display Units
Drive Units
Factory Default
Min Value
Max Value

The various elements of the parameter data are defined as :

No. – The parameter number in decimal.

Name – Parameter name as it appears on the Programming Terminal.

Type – Basic or Enhanced

Eng. Units – Specifies what engineering units will be used to display the parameter value on the Programming Terminal (RPM, % etc.). This is specified first in the Units column of the Parameter Table.

Init – Parameter value as it will appear after the Drive Initialize command has been sent from the Programming Terminal. The Init values are the same as the default values listed in the Parameter Descriptions section of this chapter.

Min – Minimum allowable value for the parameter. If no min value is given, the parameter has not been assigned a minimum limit.

Max – Maximum allowable value for the parameter. If no max value is given, the parameter has not been assigned a maximum limit.

Parameter Table (Numerical)

Table 5.A – 1336T Numerical Parameter Table

Param No.	Parameter Name	Group No.	Block Name
01	Drive Software Version	01	System Data
05	Drive Power Structure Type	01	System Data
09	Drive Link Task Interval	02	Drive to Drive Interface
10	Drive Link Baud Rate	02	Drive to Drive Interface
11	Drive Link Transmit Address	02	Drive to Drive Interface
12	Drive Link Receive 1 Address	02	Drive to Drive Interface
13	Drive Link Receive 2 Address	02	Drive to Drive Interface
14	Drive Link Transmit Indirect 1	02	Drive to Drive Interface
15	Drive Link Transmit Indirect 2	02	Drive to Drive Interface
16	Drive Link Receive 1, Indirect 1	02	Drive to Drive Interface
17	Drive Link Receive 1, Indirect 2	02	Drive to Drive Interface
18	Drive Link Receive 2, Indirect 1	02	Drive to Drive Interface
19	Drive Link Receive 2, Indirect 2	02	Drive to Drive Interface
20	Drive Link Transmit Data 1	02	Drive to Drive Interface
21	Drive Link Transmit Data 2	02	Drive to Drive Interface
22	Drive Link Receive 1, Data 1	02	Drive to Drive Interface
23	Drive Link Receive 1, Data 2	02	Drive to Drive Interface
24	Drive Link Receive 2, Data 1	02	Drive to Drive Interface
25	Drive Link Receive 2, Data 2	02	Drive to Drive Interface
26	Process Trim Output	03	Process Trim
27	Process Trim Reference	03	Process Trim
28	Process Trim Feedback	03	Process Trim
29	Process Trim Select	03	Process Trim
30	Process Trim Filter Bandwidth	03	Process Trim
31	Process Trim Data	03	Process Trim
32	Process Trim KI Gain	03	Process Trim
33	Process Trim KP Gain	03	Process Trim
34	Process Trim Low Limit	03	Process Trim
35	Process Trim High Limit	03	Process Trim
36	Process Trim Output Gain	03	Process Trim
37	Process Trim Testpoint	03	Process Trim
38	Process Trim Setpoint Select	03	Process Trim
40	Auto Tune Torque Limit	04	Autotune
41	Auto Tune Speed	04	Autotune
43	VP Desired Bandwidth	04	Autotune
44	VP Maximum Bandwidth	04	Autotune
45	VP Damping Factor	04	Autotune
46	Total Inertia	04	Autotune
47	Auto Tune Testpoint Data	04	Autotune
48	Auto Tune Testpoint Select	04	Autotune
52	Logic Command Word	05	Drive Logic
53	Torque Mode Select	05	Drive Logic
54	Local Input Status	05	Drive Logic
55	Local Output Status	05	Drive Logic

Table 5.A – 1336T Numerical Parameter Table (Cont.)

Param No.	Parameter Name	Group No.	Block Name
56	Logic Status LOW	05	Drive Logic
57	Logic Status HI	05	Drive Logic
59	Logic Options	05	Drive Logic
60	At Setpoint 1	05	Drive Logic
61	At Setpoint 2	05	Drive Logic
62	Over Setpoint 1	05	Drive Logic
63	Over Setpoint 2	05	Drive Logic
64	Over Setpoint 3	05	Drive Logic
65	Over Setpoint 4	05	Drive Logic
66	Setpoint Select	05	Drive Logic
67	Speed Setpoint Tolerance	05	Drive Logic
68	Current Setpoint Tolerance	05	Drive Logic
69	Zero Speed Tolerance	05	Drive Logic
70	Logic Testpoint Data	05	Drive Logic
71	Logic Testpoint Select	05	Drive Logic
72	Stop Dwell	05	Drive Logic
77	Maximum Dynamic Brake Power	06	Dynamic Brake
78	Maximum Dynamic Brake Temperature	06	Dynamic Brake
79	Dynamic Brake Time Constant	06	Dynamic Brake
80	Powerup/Diagnostic Fault Status	07	Drive Fault
81	Non-Configurable Fault Status	07	Drive Fault
82	CP Configurable Fault Status	07	Drive Fault
83	VP Configurable Fault Status	07	Drive Fault
84	CP Configurable Warning Status	07	Drive Fault
85	VP Configurable Warning Status	07	Drive Fault
86	CP Fault/Warning Configuration	07	Drive Fault
87	CP Warning/None Configuration Select	07	Drive Fault
88	VP Fault/Warning Configuration Select	07	Drive Fault
89	VP Warning/None Configuration Select	07	Drive Fault
90	Absolute Overspeed Threshold	07	Drive Fault
91	Stall Delay	07	Drive Fault
92	Motor Overload Limit	07	Drive Fault
93	Transistor Rjc	07	Drive Fault
94	Motor Overtemp Limit	07	Drive Fault
95	Motor Overload Speed 1	07	Drive Fault
96	Motor Overload Speed 2	07	Drive Fault
97	Minimum Overload Limit	07	Drive Fault
98	Fault Testpoint	07	Drive Fault
99	Fault Testpoint Select	07	Drive Fault
100	Velocity Reference 1 LOW (FRACTION)	08	Velocity Reference
101	Velocity Reference 1 HI (WHOLE, 32 bit)	08	Velocity Reference
102	Velocity Scale Factor 1	08	Velocity Reference
103	Velocity Reference 2 LOW (FRACTION)	08	Velocity Reference
104	Velocity Reference 2 HI (WHOLE, 32 bit)	08	Velocity Reference
105	Velocity Scale Factor 2	08	Velocity Reference
106	Velocity Trim LOW	08	Velocity Reference
107	Velocity Trim HI (32 bit)	08	Velocity Reference
108	Velocity Reference Testpoint Data LOW	08	Velocity Reference
109	Velocity Reference Testpoint Data HI (32 bit)	08	Velocity Reference
110	Velocity Reference Testpoint Select	08	Velocity Reference
117	Jog Speed 1	08	Velocity Reference
118	Jog Speed 2	08	Velocity Reference
119	Preset Speed 1	08	Velocity Reference
120	Preset Speed 2	08	Velocity Reference

Table 5.A – 1336T Numerical Parameter Table (Cont.)

Param No.	Parameter Name	Group No.	Block Name
121	Preset Speed 3	08	Velocity Reference
122	Preset Speed 4	08	Velocity Reference
123	Preset Speed 5	08	Velocity Reference
125	Accel Time	08	Velocity Reference
126	Decel Time	08	Velocity Reference
127	Reverse Motor Speed Limit	08	Velocity Reference
128	Forward Motor Speed Limit	08	Velocity Reference
129	Maximum Reverse Speed Trim	08	Velocity Reference
130	Maximum Forward Speed Trim	08	Velocity Reference
131	Droop Percent	08	Velocity Reference
132	Velocity Reference Output LOW	08	Velocity Reference
133	Velocity Reference Output HI (32 bit)	08	Velocity Reference
134	Velocity Regulator Output	09	Velocity Regulator
135	Velocity Regulator Testpoint Data LOW	09	Velocity Regulator
136	Velocity Regulator Testpoint Data HI (32 bit)	09	Velocity Regulator
137	Velocity Regulator Testpoint Select	09	Velocity Regulator
138	Velocity Error	09	Velocity Regulator
139	KI – Velocity Loop	09	Velocity Regulator
140	KP – Velocity Loop	09	Velocity Regulator
141	KF – Velocity Loop	09	Velocity Regulator
142	KF Error Filter Bandwidth	09	Velocity Regulator
143	Velocity Feedback Testpoint Data LOW	10	Velocity Feedback
144	Velocity Feedback Testpoint Data HI (32 bit)	10	Velocity Feedback
145	Velocity Feedback Testpoint Select	10	Velocity Feedback
146	Velocity Feedback	10	Velocity Feedback
147	Scaled Velocity Feedback	10	Velocity Feedback
148	Encoder Position Feedback LOW	10	Velocity Feedback
149	Encoder Position Feedback HI	10	Velocity Feedback
150	Feedback Device Type	10	Velocity Feedback
151	Feedback Tracker Gain	10	Velocity Feedback
152	Feedback Filter Select	10	Velocity Feedback
153	Kn – Feedback Filter Gain	10	Velocity Feedback
154	Wn – Feedback Filter Bandwidth	10	Velocity Feedback
155	Tach Velocity	10	Velocity Feedback
161	External Iq Reference	11	Torque Reference
162	External Torque Reference 1	11	Torque Reference
163	Slave Torque Percent 1	11	Torque Reference
164	External Torque Reference 2	11	Torque Reference
165	Slave Torque Percent 2	11	Torque Reference
166	External Torque Step	11	Torque Reference
167	Internal Torque Reference	11	Torque Reference
168	Internal Iq Reference	11	Torque Reference
171	Torque Scale % (KAL)	11	Torque Reference
172	Torque Reference Testpoint Data	11	Torque Reference
173	Torque Reference Testpoint Select	11	Torque Reference
174	Minimum Flux Level	11	Torque Reference
175	Pos Torque Reference Limit	11	Torque Reference
176	Neg Torque Reference Limit	11	Torque Reference
177	Motoring Power Limit	11	Torque Reference
178	Regen. Power Limit	11	Torque Reference
179	Positive Motor Current Reference Limit	11	Torque Reference
180	Negative Motor Current Reference Limit	11	Torque Reference
181	DI/DT Limit	11	Torque Reference
182	Computed Power	11	Torque Reference
183	Torque Limit Status	11	Torque Reference

Table 5.A – 1336T Numerical Parameter Table (Cont.)

Param No.	Parameter Name	Group No.	Block Name
220	Rated Inverter Output Amps	12	<i>Inverter Configuration</i>
221	Rated Inverter Input Voltage	12	<i>Inverter Configuration</i>
222	Inverter Carrier Frequency	12	<i>Inverter Configuration</i>
223	Precharge/Ridethru Selection	12	<i>Inverter Configuration</i>
224	Undervoltage Setpoint	12	<i>Inverter Configuration</i>
225	Bus Precharge Timeout	12	<i>Inverter Configuration</i>
226	Bus Ridethru Timeout	12	<i>Inverter Configuration</i>
227	CP Operating Options	12	<i>Inverter Configuration</i>
228	Motor Nameplate HORSEPOWER	13	<i>Motor Nameplate Data</i>
229	Base Motor Speed	13	<i>Motor Nameplate Data</i>
230	Motor Nameplate AMPS	13	<i>Motor Nameplate Data</i>
231	Motor Nameplate VOLTS	13	<i>Motor Nameplate Data</i>
232	Motor Nameplate FREQUENCY	13	<i>Motor Nameplate Data</i>
233	Motor Nameplate POLES	13	<i>Motor Nameplate Data</i>
234	Motor Inertia	13	<i>Motor Nameplate Data</i>
235	Encoder PPR	13	<i>Motor Nameplate Data</i>
236	Rs Tune (Stator Resistance)	14	<i>Motor Constants</i>
237	Lsigma Tune (Leakage Inductance)	14	<i>Motor Constants</i>
238	Id Tune (Rated Flux Current)	14	<i>Motor Constants</i>
240	Iq Tune (Base Torque Current)	15	<i>Torque Regulator</i>
241	Vde Tune (Base Torque Voltage)	15	<i>Torque Regulator</i>
242	Vqe Tune (Base Flux Voltage)	15	<i>Torque Regulator</i>
243	Vde Maximum (Peak HP)	15	<i>Torque Regulator</i>
244	Vqe Maximum (Constant HP)	15	<i>Torque Regulator</i>
245	Vde Minimum	15	<i>Torque Regulator</i>
246	Kslip (Base Slip Freq.)	15	<i>Torque Regulator</i>
247	Base Slip Freq Max	15	<i>Torque Regulator</i>
248	Base Slip Freq Min	15	<i>Torque Regulator</i>
249	Kp – Slip Regulator	15	<i>Torque Regulator</i>
250	Ki – Slip Regulator	15	<i>Torque Regulator</i>
251	Kp – Flux Regulator	15	<i>Torque Regulator</i>
252	Ki – Flux Regulator	15	<i>Torque Regulator</i>
256	Autotune/Diagnostics Selection	16	<i>Autotune/Diagnostics</i>
257	Transistor Diagnostics Configuration	16	<i>Autotune/Diagnostics</i>
258	Inverter Diagnostics Result #1	16	<i>Autotune/Diagnostics</i>
259	Inverter Diagnostics Result #2	16	<i>Autotune/Diagnostics</i>
260	Iq OFFSET	16	<i>Autotune/Diagnostics</i>
261	Id OFFSET	16	<i>Autotune/Diagnostics</i>
262	Phase Rotation Current Reference	16	<i>Autotune/Diagnostics</i>
263	Phase Rotation Frequency Reference	16	<i>Autotune/Diagnostics</i>
264	Motor Current Magnitude Feedback	17	<i>Metering</i>
265	Motor Voltage Magnitude	17	<i>Metering</i>
266	Stator Frequency	17	<i>Metering</i>
267	Torque Feedback	17	<i>Metering</i>
268	DC Bus Voltage	17	<i>Metering</i>
269	Motor Temperature Feedback	17	<i>Metering</i>
270	Inverter Temperature Feedback	17	<i>Metering</i>
271	Limited Motor Flux	17	<i>Metering</i>
273	Testpoint Selection #1	18	<i>Torque Blk Test Pnt Sel</i>
274	Testpoint Data #1	18	<i>Torque Blk Test Pnt Sel</i>
275	Testpoint Selection #2	18	<i>Torque Blk Test Pnt Sel</i>
276	Testpoint Data #2	18	<i>Torque Blk Test Pnt Sel</i>
277	Testpoint Selection #3	18	<i>Torque Blk Test Pnt Sel</i>
278	Testpoint Data #3	18	<i>Torque Blk Test Pnt Sel</i>
279	Testpoint Selection #4	18	<i>Torque Blk Test Pnt Sel</i>
280	Testpoint Data #4	18	<i>Torque Blk Test Pnt Sel</i>

Table 5.A – 1336T Numerical Parameter Table (Cont.)

Param No.	Parameter Name	Group No.	Block Name
281	Testpoint Selection #5	18	<i>Torque Blk Test Point Sel</i>
282	Testpoint Data #5	18	<i>Torque Blk Test Point Sel</i>
283	Testpoint Selection #6	18	<i>Torque Blk Test Point Sel</i>
284	Testpoint Data #6	18	<i>Torque Blk Test Point Sel</i>
285	Selection for Test DAC 1	18	<i>Torque Blk Test Point Sel</i>
286	Selection for Test DAC 2	18	<i>Torque Blk Test Point Sel</i>
287	Dvbus dt	19	<i>Torque Blk Test Point Sel</i>
288	Bus Counts	19	<i>Torque Blk Test Point Sel</i>

**GROUP NO. 01
SYSTEM DATA**

<p>Drive Software Version [Software Version]</p> <p>This parameter stores the present software revision for the firmware in the product. The firmware value represents the software version in the range 00.0 to 99.9</p>	<table border="1"> <tr> <td>Parameter Number</td> <td>001</td> </tr> <tr> <td>Parameter Type</td> <td>Basic, Source</td> </tr> <tr> <td>Display Units</td> <td>x.xx</td> </tr> <tr> <td>Drive Units</td> <td>Display units x 100</td> </tr> <tr> <td>Factory Default</td> <td>1.01</td> </tr> <tr> <td>Minimum Value</td> <td>0.00</td> </tr> <tr> <td>Maximum Value</td> <td>9.99</td> </tr> </table>	Parameter Number	001	Parameter Type	Basic, Source	Display Units	x.xx	Drive Units	Display units x 100	Factory Default	1.01	Minimum Value	0.00	Maximum Value	9.99
Parameter Number	001														
Parameter Type	Basic, Source														
Display Units	x.xx														
Drive Units	Display units x 100														
Factory Default	1.01														
Minimum Value	0.00														
Maximum Value	9.99														
<p>Power Structure Type [Drive Type]</p> <p>This number is a unique code that identifies the drive's current and voltage ratings. This number originates from a serial EE memory located on the drive's Base Drive Board.</p>	<table border="1"> <tr> <td>Parameter Number</td> <td>005</td> </tr> <tr> <td>Parameter Type</td> <td>Basic, Source</td> </tr> <tr> <td>Display Units</td> <td>x</td> </tr> <tr> <td>Drive Units</td> <td>x</td> </tr> <tr> <td>Factory Default</td> <td>0u</td> </tr> <tr> <td>Minimum Value</td> <td>0u</td> </tr> <tr> <td>Maximum Value</td> <td>65635u</td> </tr> </table>	Parameter Number	005	Parameter Type	Basic, Source	Display Units	x	Drive Units	x	Factory Default	0u	Minimum Value	0u	Maximum Value	65635u
Parameter Number	005														
Parameter Type	Basic, Source														
Display Units	x														
Drive Units	x														
Factory Default	0u														
Minimum Value	0u														
Maximum Value	65635u														

GROUP NO. 02
DRIVE TO DRIVE
INTERFACE

Drive Link Task Interval [D2D Tsk Interval] This parameter specifies the interval at which drive to drive data will be transmitted and received. The intervals are 2 ms in tervals up to 20 ms.	Parameter Number	9
	Parameter Type	Enhanced
	Display Units	x
	Drive Units	x
	Factory Default	1u
	Minimum Value	1u
	Maximum Value	10u

Drive Link Baud Rate [D2D Baud Rate] This word parameter specifies the baud rate used on the drive-to-drive link (CAN) communication interface as follows: 00H = 125K baud 01H = 250K baud 02H = 500K baud	Parameter Number	10
	Parameter Type	Enhanced
	Display Units	x
	Drive Units	x
	Factory Default	0u
	Minimum Value	0u
	Maximum Value	2u

Drive Link Transmit Address [D2D Xmit Addr] This parameter specifies the node address at which two words of data will be transmitted. A value of zero disables the transmit function.	Parameter Number	11
	Parameter Type	Enhanced
	Display Units	x
	Drive Units	x
	Factory Default	0u
	Minimum Value	0u
	Maximum Value	64u

Drive Link Receive 1 Address [D2D Rcv Addr 1] This parameter specifies the node address at which two words of data will be received. A value of zero disables the receive function.	Parameter Number	12
	Parameter Type	Enhanced
	Display Units	x
	Drive Units	x
	Factory Default	0u
	Minimum Value	0u
	Maximum Value	64u

Drive Link Receive 2 Address [D2D Rcv Addr 2] This parameter specifies the node address at which two words of data will be received. A value of zero disables the receive function.	Parameter Number	13
	Parameter Type	Enhanced
	Display Units	x
	Drive Units	
	Factory Default	0
	Minimum Value	0
	Maximum Value	64

Drive Link Transmit Indirect 1 [D2D Xmit Ind 1] This is a word parameter defining the parameter number which data will be fetched from to be transmitted in the high speed communication network (CAN) for the first word location of the transmitted message.	Parameter Number	14
	Parameter Type	Enhanced
	Display Units	x
	Drive Units	x
	Factory Default	20u
	Minimum Value	1u
	Maximum Value	219u

Drive Link Transmit Indirect 2 [D2D Xmit Ind 2] This is a word parameter defining the parameter number which data will be fetched from to be transmitted in the high speed communication network (CAN) for the 2nd word location of the transmitted message.	Parameter Number	15
	Parameter Type	Enhanced
	Display Units	x
	Drive Units	x
	Factory Default	21u
	Minimum Value	1u
	Maximum Value	219u

**GROUP NO. 02
DRIVE TO DRIVE
INTERFACE**

<p>Drive Link Receive 1, Indirect 1 [D2D Rcv1 Ind1]</p> <p>This parameter specifies the parameter number where the first word of data will be put after it has been received from the drive to drive communication.</p>	<table border="1"> <tr><td>Parameter Number</td><td>16</td></tr> <tr><td>Parameter Type</td><td>Enhanced</td></tr> <tr><td>Display Units</td><td>x</td></tr> <tr><td>Drive Units</td><td>x</td></tr> <tr><td>Factory Default</td><td>22u</td></tr> <tr><td>Minimum Value</td><td>1u</td></tr> <tr><td>Maximum Value</td><td>219u</td></tr> </table>	Parameter Number	16	Parameter Type	Enhanced	Display Units	x	Drive Units	x	Factory Default	22u	Minimum Value	1u	Maximum Value	219u
Parameter Number	16														
Parameter Type	Enhanced														
Display Units	x														
Drive Units	x														
Factory Default	22u														
Minimum Value	1u														
Maximum Value	219u														
<p>Drive Link Receive 1, Indirect 2 [D2D Rcv1 Ind2]</p> <p>This parameter specifies the parameter number where the second word of data will be put after it has been received from the drive to drive communication.</p>	<table border="1"> <tr><td>Parameter Number</td><td>17</td></tr> <tr><td>Parameter Type</td><td>Enhanced</td></tr> <tr><td>Display Units</td><td>x</td></tr> <tr><td>Drive Units</td><td>x</td></tr> <tr><td>Factory Default</td><td>23u</td></tr> <tr><td>Minimum Value</td><td>1u</td></tr> <tr><td>Maximum Value</td><td>219u</td></tr> </table>	Parameter Number	17	Parameter Type	Enhanced	Display Units	x	Drive Units	x	Factory Default	23u	Minimum Value	1u	Maximum Value	219u
Parameter Number	17														
Parameter Type	Enhanced														
Display Units	x														
Drive Units	x														
Factory Default	23u														
Minimum Value	1u														
Maximum Value	219u														
<p>Drive Link Receive 2, Indirect 1 [D2D Rcv2, Ind1]</p> <p>This parameter specifies the parameter number where the first word of data will be put after it has been received from the drive to drive communication.</p>	<table border="1"> <tr><td>Parameter Number</td><td>18</td></tr> <tr><td>Parameter Type</td><td>Enhanced</td></tr> <tr><td>Display Units</td><td>x</td></tr> <tr><td>Drive Units</td><td>x</td></tr> <tr><td>Factory Default</td><td>24u</td></tr> <tr><td>Minimum Value</td><td>1u</td></tr> <tr><td>Maximum Value</td><td>219u</td></tr> </table>	Parameter Number	18	Parameter Type	Enhanced	Display Units	x	Drive Units	x	Factory Default	24u	Minimum Value	1u	Maximum Value	219u
Parameter Number	18														
Parameter Type	Enhanced														
Display Units	x														
Drive Units	x														
Factory Default	24u														
Minimum Value	1u														
Maximum Value	219u														
<p>Drive Link Receive 2, Indirect 2 [D2D Rcv2, Ind2]</p> <p>This parameter specifies the parameter number where the second word of data will be put after it has been received from the drive to drive communication.</p>	<table border="1"> <tr><td>Parameter Number</td><td>19</td></tr> <tr><td>Parameter Type</td><td>Enhanced</td></tr> <tr><td>Display Units</td><td>x</td></tr> <tr><td>Drive Units</td><td>x</td></tr> <tr><td>Factory Default</td><td>25u</td></tr> <tr><td>Minimum Value</td><td>1u</td></tr> <tr><td>Maximum Value</td><td>219u</td></tr> </table>	Parameter Number	19	Parameter Type	Enhanced	Display Units	x	Drive Units	x	Factory Default	25u	Minimum Value	1u	Maximum Value	219u
Parameter Number	19														
Parameter Type	Enhanced														
Display Units	x														
Drive Units	x														
Factory Default	25u														
Minimum Value	1u														
Maximum Value	219u														
<p>Drive Link Transmit Data 1 [D2D Xmit Data1]</p> <p>This parameter is the default data location of the first word of data for transmit.</p>	<table border="1"> <tr><td>Parameter Number</td><td>20</td></tr> <tr><td>Parameter Type</td><td>Enhanced</td></tr> <tr><td>Display Units</td><td>x</td></tr> <tr><td>Drive Units</td><td>x</td></tr> <tr><td>Factory Default</td><td>0</td></tr> <tr><td>Minimum Value</td><td>-32767</td></tr> <tr><td>Maximum Value</td><td>+32767</td></tr> </table>	Parameter Number	20	Parameter Type	Enhanced	Display Units	x	Drive Units	x	Factory Default	0	Minimum Value	-32767	Maximum Value	+32767
Parameter Number	20														
Parameter Type	Enhanced														
Display Units	x														
Drive Units	x														
Factory Default	0														
Minimum Value	-32767														
Maximum Value	+32767														
<p>Drive Link Transmit Data 2 [D2D Xmit Data2]</p> <p>This parameter is the default data location of the second word of data for transmit.</p>	<table border="1"> <tr><td>Parameter Number</td><td>21</td></tr> <tr><td>Parameter Type</td><td>Enhanced</td></tr> <tr><td>Display Units</td><td>x</td></tr> <tr><td>Drive Units</td><td>x</td></tr> <tr><td>Factory Default</td><td>0</td></tr> <tr><td>Minimum Value</td><td>-32767</td></tr> <tr><td>Maximum Value</td><td>32767</td></tr> </table>	Parameter Number	21	Parameter Type	Enhanced	Display Units	x	Drive Units	x	Factory Default	0	Minimum Value	-32767	Maximum Value	32767
Parameter Number	21														
Parameter Type	Enhanced														
Display Units	x														
Drive Units	x														
Factory Default	0														
Minimum Value	-32767														
Maximum Value	32767														
<p>Drive Link Receive 1, Data 1 [D2D Rcv1, Data1]</p> <p>This parameter is the default data location of the first word of data for receive 1</p>	<table border="1"> <tr><td>Parameter Number</td><td>22</td></tr> <tr><td>Parameter Type</td><td>Enhanced</td></tr> <tr><td>Display Units</td><td>x</td></tr> <tr><td>Drive Units</td><td>x</td></tr> <tr><td>Factory Default</td><td>0</td></tr> <tr><td>Minimum Value</td><td>-32767</td></tr> <tr><td>Maximum Value</td><td>32767</td></tr> </table>	Parameter Number	22	Parameter Type	Enhanced	Display Units	x	Drive Units	x	Factory Default	0	Minimum Value	-32767	Maximum Value	32767
Parameter Number	22														
Parameter Type	Enhanced														
Display Units	x														
Drive Units	x														
Factory Default	0														
Minimum Value	-32767														
Maximum Value	32767														

GROUP NO. 02
DRIVE TO DRIVE
INTERFACE

Drive Link Receive 1, Data 2
[D2D Rcv1, Data 2]
This parameter is the default data location
of the second word of data for receive 1

Parameter Number 23
Parameter Type Enhanced
Display Units x
Drive Units x
Factory Default 0
Minimum Value -32767
Maximum Value 32767

Drive Link Receive 2, Data 1
[D2D Rcv 2 Data 1]
This parameter is the default data location
of the first word of data for receive 2

Parameter Number 24
Parameter Type Enhanced
Display Units x
Drive Units x
Factory Default 0
Minimum Value -32767
Maximum Value 32767

Drive Link Receive 2, Data 2
[D2D Rcv 2 Data 2]
This parameter is the default data location
of the second word of data for receive 2

Parameter Number 25
Parameter Type Enhanced
Display Units x
Drive Units x
Factory Default 0
Minimum Value -32767
Maximum Value 32767

GROUP NO. 03
PROCESS TRIM

Process Trim Output
[Proc Trim Output]

This parameter represents the scaled and limited output of the process trim function. Process Trim consists of a general purpose PI regulator that uses unspecified reference and feedback inputs.

Parameter Number	26
Parameter Type	Enhanced
Display Units	+/- x.x%
Drive Units	4096 = 100% trim
Factory Default	+ 0.0%
Minimum Value	- 800%
Maximum Value	+ 800%

Process Trim Reference
[Proc Trim Ref]

This is the reference input value for process trim. The Process Trim Output is updated based on the value of this input.

Parameter Number	27
Parameter Type	Enhanced
Display Units	+/- x.x%
Drive Units	4096 = 100% trim
Factory Default	+0.0%
Minimum Value	- 800%
Maximum Value	+800%

Process Trim Feedback
[Proc Trim Fdbk]

This is the feedback input value for process trim. The Process Trim Output parameter is updated based on the value of this input.

Parameter Number	28
Parameter Type	Enhanced
Display Units	+/- x.x%
Drive Units	4096 = 100% trim
Factory Default	+ 0.0%
Minimum Value	- 800%
Maximum Value	+ 800%

Process Trim Select
[Proc Trim Select]

This is a bit coded word of data containing several selection options for the process trim regulator as follows:

- Bit 0 Trim the Velocity Reference
- Bit 1 Trim the Torque Reference
- Bit 2 Config as Outer Velocity Trim Loop
- Bit 3 Set Output Option
- Bit 4 Preset Integrator Option
- Bit 5 Force ON Trim Limit option

Parameter Number	29
Parameter Type	Enhanced
Display Units	Bits
Drive Units	Bits
Factory Default	0000 hex
Minimum Value	0000 hex
Maximum Value	003F hex

Process Trim Filter Bandwidth
[Proc Trim Fltr W]

This parameter determines the bandwidth of a single pole filter used with the error input for process trim. The output of this filter is used as the input to the process trim regulator.

Parameter Number	30
Parameter Type	Enhanced
Display Units	R/S
Drive Units	x radians/sec
Factory Default	0 r/s
Minimum Value	0 r/s
Maximum Value	120 r/s

Process Trim Data
[Proc Trim Data]

This parameter is used to preset the output of the process trim regulator when either the "Set Output Option" or "Preset Integrator Option" is selected in parameter 29.

Parameter Number	31
Parameter Type	Enhanced
Display Units	+/- x.x%
Drive Units	4096 = 100% preload
Factory Default	+0.0%
Minimum Value	-800%
Maximum Value	+800%

Chapter 5 Programming Parameters

GROUP NO. 03 PROCESS TRIM

<p>Process Trim KI Gain [Proc Trim KI]</p> <p>This parameter controls the integral gain of the process trim regulator. If process trim equals 1.0, then the process trim PI regulator output will equal 1 pu in 1 second, for 1 pu process trim error.</p>	<table border="1"> <tbody> <tr><td>Parameter Number</td><td>32</td></tr> <tr><td>Parameter Type</td><td>Enhanced</td></tr> <tr><td>Display Units</td><td>x.xxx</td></tr> <tr><td>Drive Units</td><td>4096 = 1.000 Ki gain</td></tr> <tr><td>Factory Default</td><td>1.000</td></tr> <tr><td>Minimum Value</td><td>0.000</td></tr> <tr><td>Maximum Value</td><td>16.000</td></tr> </tbody> </table>	Parameter Number	32	Parameter Type	Enhanced	Display Units	x.xxx	Drive Units	4096 = 1.000 Ki gain	Factory Default	1.000	Minimum Value	0.000	Maximum Value	16.000										
Parameter Number	32																								
Parameter Type	Enhanced																								
Display Units	x.xxx																								
Drive Units	4096 = 1.000 Ki gain																								
Factory Default	1.000																								
Minimum Value	0.000																								
Maximum Value	16.000																								
<p>Process Trim KP Gain [Proc Trim KP]</p> <p>This parameter controls the proportional gain of the process trim regulator. If the KP process trim is equal to 1.0, then the process trim PI regulator output will equal 1 pu for 1 pu process trim error.</p>	<table border="1"> <tbody> <tr><td>Parameter Number</td><td>33</td></tr> <tr><td>Parameter Type</td><td>Enhanced</td></tr> <tr><td>Display Units</td><td>x.xxx</td></tr> <tr><td>Drive Units</td><td>4096 = 1.0000 Kp gain</td></tr> <tr><td>Factory Default</td><td>1.000</td></tr> <tr><td>Minimum Value</td><td>0.000</td></tr> <tr><td>Maximum Value</td><td>16.000</td></tr> </tbody> </table>	Parameter Number	33	Parameter Type	Enhanced	Display Units	x.xxx	Drive Units	4096 = 1.0000 Kp gain	Factory Default	1.000	Minimum Value	0.000	Maximum Value	16.000										
Parameter Number	33																								
Parameter Type	Enhanced																								
Display Units	x.xxx																								
Drive Units	4096 = 1.0000 Kp gain																								
Factory Default	1.000																								
Minimum Value	0.000																								
Maximum Value	16.000																								
<p>Process Trim Low Limit [Proc Trim Lo Lmt]</p> <p>The output of the process trim regulator is limited by adjustable high and low limits. This parameter specifies the high limit of the process trim output value.</p>	<table border="1"> <tbody> <tr><td>Parameter Number</td><td>34</td></tr> <tr><td>Parameter Type</td><td>Enhanced</td></tr> <tr><td>Display Units</td><td>+/- x.x%</td></tr> <tr><td>Drive Units</td><td>4096 = 100% trim</td></tr> <tr><td>Factory Default</td><td>- 100%</td></tr> <tr><td>Minimum Value</td><td>- 800%</td></tr> <tr><td>Maximum Value</td><td>+ 800%</td></tr> </tbody> </table>	Parameter Number	34	Parameter Type	Enhanced	Display Units	+/- x.x%	Drive Units	4096 = 100% trim	Factory Default	- 100%	Minimum Value	- 800%	Maximum Value	+ 800%										
Parameter Number	34																								
Parameter Type	Enhanced																								
Display Units	+/- x.x%																								
Drive Units	4096 = 100% trim																								
Factory Default	- 100%																								
Minimum Value	- 800%																								
Maximum Value	+ 800%																								
<p>Process Trim High Limit [Proc Trim Hi Lmt]</p> <p>The output of the process trim regulator is limited by adjustable high and low limits. This parameter specifies the high limit of the process trim output value.</p>	<table border="1"> <tbody> <tr><td>Parameter Number</td><td>35</td></tr> <tr><td>Parameter Type</td><td>Enhanced</td></tr> <tr><td>Display Units</td><td>+/- x.x%</td></tr> <tr><td>Drive Units</td><td>4096 = 100% trim</td></tr> <tr><td>Factory Default</td><td>- 100%</td></tr> <tr><td>Minimum Value</td><td>- 800%</td></tr> <tr><td>Maximum Value</td><td>+ 800%</td></tr> </tbody> </table>	Parameter Number	35	Parameter Type	Enhanced	Display Units	+/- x.x%	Drive Units	4096 = 100% trim	Factory Default	- 100%	Minimum Value	- 800%	Maximum Value	+ 800%										
Parameter Number	35																								
Parameter Type	Enhanced																								
Display Units	+/- x.x%																								
Drive Units	4096 = 100% trim																								
Factory Default	- 100%																								
Minimum Value	- 800%																								
Maximum Value	+ 800%																								
<p>Process Trim Output Gain [Proc Trim Out K]</p> <p>The output of the process trim regulator is scaled by a gain factor. This occurs just before the upper and lower limit. This parameter specifies the gain value to use.</p>	<table border="1"> <tbody> <tr><td>Parameter Number</td><td>36</td></tr> <tr><td>Parameter Type</td><td>Enhanced</td></tr> <tr><td>Display Units</td><td>+/- x.xx</td></tr> <tr><td>Drive Units</td><td>2048 = +1.000 gain</td></tr> <tr><td>Factory Default</td><td>+ 1.000</td></tr> <tr><td>Minimum Value</td><td>- 16.00</td></tr> <tr><td>Maximum Value</td><td>+ 16.00</td></tr> </tbody> </table>	Parameter Number	36	Parameter Type	Enhanced	Display Units	+/- x.xx	Drive Units	2048 = +1.000 gain	Factory Default	+ 1.000	Minimum Value	- 16.00	Maximum Value	+ 16.00										
Parameter Number	36																								
Parameter Type	Enhanced																								
Display Units	+/- x.xx																								
Drive Units	2048 = +1.000 gain																								
Factory Default	+ 1.000																								
Minimum Value	- 16.00																								
Maximum Value	+ 16.00																								
<p>Process Trim Testpoint [Proc Trim TP]</p> <p>This parameter indicates the value of the internal location selected by the Process Trim Testpoint Select parameter.</p>	<table border="1"> <tbody> <tr><td>Parameter Number</td><td>37</td></tr> <tr><td>Parameter Type</td><td>Enhanced</td></tr> <tr><td>Display Units</td><td>+/- x</td></tr> <tr><td>Drive Units</td><td>+/- x</td></tr> <tr><td>Factory Default</td><td>+0</td></tr> <tr><td>Minimum Value</td><td>-32767</td></tr> <tr><td>Maximum Value</td><td>+32767</td></tr> </tbody> </table>	Parameter Number	37	Parameter Type	Enhanced	Display Units	+/- x	Drive Units	+/- x	Factory Default	+0	Minimum Value	-32767	Maximum Value	+32767										
Parameter Number	37																								
Parameter Type	Enhanced																								
Display Units	+/- x																								
Drive Units	+/- x																								
Factory Default	+0																								
Minimum Value	-32767																								
Maximum Value	+32767																								
<p>Process Trim Testpoint Select [Proc Trim TP Sel]</p> <p>This parameter selects which location of the Process Trim Controller will become the testpoint value as follows:</p> <table border="1"> <thead> <tr> <th>Value</th> <th>Process Trim Access Point</th> </tr> </thead> <tbody> <tr><td>0</td><td>Zero</td></tr> <tr><td>1</td><td>Process Trim Error</td></tr> <tr><td>2</td><td>Process Trim Filter Output</td></tr> <tr><td>3</td><td>Process Trim Control Word</td></tr> </tbody> </table>	Value	Process Trim Access Point	0	Zero	1	Process Trim Error	2	Process Trim Filter Output	3	Process Trim Control Word	<table border="1"> <tbody> <tr><td>Parameter Number</td><td>38</td></tr> <tr><td>Parameter Type</td><td>Enhanced</td></tr> <tr><td>Display Units</td><td>+/- x</td></tr> <tr><td>Drive Units</td><td>x</td></tr> <tr><td>Factory Default</td><td>0</td></tr> <tr><td>Minimum Value</td><td>0</td></tr> <tr><td>Maximum Value</td><td>3</td></tr> </tbody> </table>	Parameter Number	38	Parameter Type	Enhanced	Display Units	+/- x	Drive Units	x	Factory Default	0	Minimum Value	0	Maximum Value	3
Value	Process Trim Access Point																								
0	Zero																								
1	Process Trim Error																								
2	Process Trim Filter Output																								
3	Process Trim Control Word																								
Parameter Number	38																								
Parameter Type	Enhanced																								
Display Units	+/- x																								
Drive Units	x																								
Factory Default	0																								
Minimum Value	0																								
Maximum Value	3																								

**GROUP NO. 04
AUTOTUNE**

Auto Tune Torque Limit
[Auto Tune T Lmt]

This parameter specifies the motor torque that is applied to the motor during the Velocity motor test and the Velocity system test. 4096 = 100% rated motor torque.

Parameter Number	40
Parameter Type	Enhanced, Sink
Display Units	x.x %
Drive Units	4096 @ rated motor torque
Factory Default	50.0 %
Minimum Value	25.0 %
Maximum Value	100.0 %

Auto Tune Speed
[Auto Tune Speed]

This parameter is the speed of the motor during an auto tune velocity motor test, system test, and system ID measure. 4096 is base speed

Parameter Number	41
Parameter Type	Enhanced, Sink
Display Units	+/- x.x rpm
Drive Units	4096 @ Base Motor Speed
Factory Default	0.85 Times Base Motor Speed
Minimum Value	0.3 Times Base Motor Speed
Maximum Value	Base Motor Speed

VP Desired Bandwidth
[Vel Desired BW]

This parameter specifies the velocity loop bandwidth requested by the User and determines the dynamic behavior of the velocity loop. The velocity loop becomes more responsive and is able to track a faster changing velocity reference as the bandwidth is increased.

Parameter Number	43
Parameter Type	Enhanced, Sink
Display Units	x.xx rad/sec
Drive Units	Display units x 100
Factory Default	5.00 rad/s
Minimum Value	0.01 rad/s
Maximum Value	100.00 rad/s

VP Maximum Bandwidth
[Vel Maximum BW]

This parameter specifies the maximum achievable velocity loop bandwidth as calculated by the velocity processor. The maximum velocity loop bandwidth is not changeable by the user.

Parameter Number	44
Parameter Type	Enhanced, Source
Display Units	x.xx rad/sec
Drive Units	Display units x 100
Factory Default	50.00 rad/s
Minimum Value	0.01 rad/s
Maximum Value	100.0 rad/s

VP Damping Factor
[Vel Damp Factor]

This parameter determines the dynamic behavior of the velocity loop. The damping factor influences the amount of overshoot the velocity loop will exhibit during a transient.

Parameter Number	45
Parameter Type	Enhanced, Sink
Display Units	x.x
Drive Units	2048 = 1.0 damping
Factory Default	1.0
Minimum Value	0.5
Maximum Value	3.0

Total Inertia
[Total Inertia]

This parameter represents the time, in seconds, for a motor coupled to a load to accelerate from zero to base speed, at rated motor torque. This parameter is calculated by the Autotune System Inverter Test.

Parameter Number	46
Parameter Type	Enhanced, Sink
Display Units	x.xx sec
Drive Units	Display units x 100
Factory Default	2.0 sec
Minimum Value	0.01 sec
Maximum Value	655 sec

Autotune Testpoint Data
[Auto Tune TP]

This parameter indicates the value of the internal location selected by the Autotune Testpoint Select parameter.

Parameter Number	47
Parameter Type	Basic
Display Units	Bits
Drive Units	Bits
Factory Default	0000 hex
Minimum Value	0000 hex
Maximum Value	FFFF hex

Chapter 5
Programming Parameters

GROUP NO. 04
AUTOTUNE

Auto Tune Testpoint Select
[Auto Tune TP SEL]

This parameter selects what internal location of the Velocity Auto Tune Controller will become the testpoint value. The internal locations available are:

Select Value	Autotune Access Point
0	Zero
1	Autotune Status Bits
2	Autotune Inhibit Word (all zero = OK)
3	Autotune Error Word (all zero = OK)
4	Calculated Friction (4096 @ 1 pu)

Parameter Number	48
Parameter Type	Basic
Display Units	x
Drive Units	x
Factory Default	0
Minimum Value	0
Maximum Value	10

Select Value	Autotune Access Point
5	Torque Limit for autotune
6	Autotune State Word 1
7	Autotune State Word 2
8	Autotune Control Bits
9	Minimum Limit for di/dt to achieve requested bandwidth
10	Minimum error filter bandwidth

GROUP NO. 05
DRIVE LOGIC

Logic Command Word
[Logic Command]

This word parameter contains data used to Control Drive logic operation. If a bit is set the function is enabled, otherwise it is disabled (inactive).

Parameter Number	52
Parameter Type	Basic
Display Units	Bits
Drive Units	Bits
Factory Default	0000 hex
Minimum Value	0000 hex
Maximum Value	FFFF hex

BITS

C	B	A	
0	0	0	- Zero
0	0	1	- External Ref
0	1	0	- Preset Speed 1
0	1	1	- Preset Speed 2
1	0	0	- Preset Speed 3
1	0	1	- Preset Speed 4
1	1	0	- Preset Speed 5
1	1	1	- External Ref. 2

- 0 - Ramp Stop
- 1 - Start
- 2 - Jog 1
- 3 - Clear Fault
- 4 - Forward
- 5 - Reverse
- 6 - Jog 2
- 7 - Current Limit Stop
- 8 - Coast Stop
- 9 - Ramp Disable
- 10 - Flux Enable
- 11 - Process Trim Enable
- 12 - Velocity Ref Select A
- 13 - Velocity Ref Select B
- 14 - Velocity Ref Select C
- 15 - Reset Drive

Torque Mode Select
[Torque Mode Sel]

This is a word parameter used to select the source for the drive torque reference. The operation of this parameter functions as a selector switch. The position of the selector determines the torque reference selection as follows:

Value	Description	Value	Description
0	Zero Torque	3	Min Select Speed/Torque
1	Velocity Regulate	4	Max Select Speed/Torque
2	External Torque	5	Sum Speed and Torque

Parameter Number	53
Parameter Type	Basic
Display Units	Bits
Drive Units	Bits
Factory Default	1
Minimum Value	0
Maximum Value	5

**GROUP NO. 05
DRIVE LOGIC**

Local Input Status
[Local In Status]

This parameter indicates boolean input status conditions for the Velocity Processor. When a bit is set to 1, the corresponding input signal is true.

Parameter Number	54
Parameter Type	Basic
Display Units	Bits
Drive Units	Bits
Factory Default	0000 hex
Minimum Value	0000 hex
Maximum Value	FFFF hex

Value	Description	Value	Description	Value	Description	Value	Description
0	Brake Request	4	External Fault	8	Inverter Status	12	Not Used
1	Drive Enable	5	Not Used	9	Contactory Verify	13	Not Used
2	Motor Overtemp Thermoguard	6	Test Input	10	Not Used	14	Not Used
3	Discrete Stop	7	Not Used	11	Not Used	15	Not Used

Local Output Status
[Local Out Status]

This parameter indicates boolean output status conditions for the Velocity Processor. When a bit is set to 1, the corresponding output signal is true.

Parameter Number	55
Parameter Type	Basic
Display Units	Bits
Drive Units	Bits
Factory Default	0000 hex
Minimum Value	0000 hex
Maximum Value	FFFF hex

Value	Description	Value	Description	Value	Description	Value	Description
0	Brake Enable	4	Not Used	8	Not Used	12	VP Green LED
1	Turn On Delay Select	5	Not Used	9	VP Enable	13	VP Red LED
2	Not Used	6	Not Used	10	Pilot Relay	14	Not Used
3	Not Used	7	Not Used	11	Faulted Output	15	Not Used

Logic Status Low
[Logic Status Low]

This parameter is the Low part of a double word that indicates boolean logic conditions within the Drive. When a bit is set to 1, the corresponding condition in the Drive is true.

Parameter Number	56
Parameter Type	Basic
Display Units	Bits
Drive Units	Bits
Factory Default	0000 hex
Minimum Value	0000 hex
Maximum Value	FFFF hex

Value	Description	Value	Description	Value	Description	Value	Description
0	Ready to Run	4	Accelerating (1=Accel)	8	At Set Speed	12	At Zero Speed
1	Drive Running	5	Decelerating (1=Decel)	9	Local A	13	Reference A
2	Cmd Direction (1=FWD, 0=Rev)	6	Warning	10	Local B	14	Reference B
3	Rotation Direction (1=FWD, 0=Rev)	7	Faulted	11	Local C	15	Reference C

Logic Status HI
[Logic Status HI]

This parameter is the Hi part of a double word that indicates boolean logic conditions within the Drive. When a bit is set to 1, the corresponding condition in the Drive is true.

Parameter Number	57
Parameter Type	Basic
Display Units	Bits
Drive Units	Bits
Factory Default	0000 hex
Minimum Value	0000 hex
Maximum Value	FFFF hex

Value	Description	Value	Description	Value	Description	Value	Description
0	Flux Ready	4	Bus Ridethru	8	At Limit	12	Over Setpoint 1
1	Flux Up	5	Jogging	9	Not Used	13	Over Setpoint 2
2	Diagnostics Completed	6	Autotune Status A	10	At Setpoint 1	14	Over Setpoint 3
3	Diagnostics Aborted	7	Autotune Status B	11	At Setpoint 2	15	Over Setpoint 4

GROUP NO. 05
DRIVE LOGIC

Logic Options
[Logic Options]

This parameter selects the options for logic operation of the drive as follows:

Parameter Number	59
Parameter Type	Basic
Display Units	Bits
Drive Units	Bits
Factory Default	01C0 hex
Minimum Value	0000 hex
Maximum Value	FFFF hex

Bit#	Option
0	Start Type A*
1	Start Type B*
2	Jog Ramp Enable
3	= 1 / Jog Coast = 0 / Regen Stop
4	STOP Input Type A**
5	STOP Input Type B**
6	Do Power Up Diag.
7	Do Flux Up Diag
8	Do Start Diag
9	= 1 / User Torque Mode Stop = 0 / Zero torque
10	= 1 / Stopped when zero speed = 0 / Zero torque
11	= 1 / AC Motor Contactor Present
12	= 1 / Bipolar Ref = 0 / Unipolar
13	= 1 / Disable Bumpless Torque Calc.

***Start Type Description:**

	B	A
Maintained Start, Regen STOP	0	0
Maintained Start, Coast STOP	0	1
Momentary Start	1	0
Maintained Start, Regen STOP	1	1

****Stop Input Description:**

	B	A
COAST	0	0
Normal	0	1
Current Limit	1	0
COAST	1	1

At Setpoint 1
[At Setpoint 1]

This parameter is used to specify the setpoint threshold for the At Setpoint 1 bit in Logic Status HI.

Parameter Number	60
Parameter Type	Basic
Display Units	+/- x %
Drive Units	4096 = 100% setpoint
Factory Default	+0.0%
Minimum Value	-800.0%
Maximum Value	+800.0%

At Setpoint 2
[At Setpoint 2]

This parameter is used to specify the setpoint threshold for the At Setpoint 2 bit in Logic Status HI.

Parameter Number	61
Parameter Type	Basic
Display Units	+/- x %
Drive Units	4096 = 100% setpoint
Factory Default	+0.0%
Minimum Value	-800%
Maximum Value	+800%

Over Setpoint 1
[Over Setpoint 1]

This parameter is used to specify the setpoint threshold for the Over Setpoint 1 bit in Logic Status HI.

Parameter Number	62
Parameter Type	Basic
Display Units	+/- x.%
Drive Units	4096 = 100% setpoint
Factory Default	+0%
Minimum Value	-800%
Maximum Value	+800%

**GROUP NO. 05
DRIVE LOGIC**

Over Setpoint 2
[Over Setpoint 2]

This parameter is used to specify the setpoint threshold for the Over Setpoint 2 bit in Logic Status HI.

Parameter Number	63
Parameter Type	Basic
Display Units	+/- x%
Drive Units	4096 = 100% setpoint
Factory Default	+ 0%
Minimum Value	-800%
Maximum Value	+800%

Over Setpoint 3
[OverSetpoint 3]

This parameter is used to specify the setpoint threshold for the Over Setpoint 3 bit in Logic Status HI.

Parameter Number	64
Parameter Type	Basic
Display Units	+/- x%
Drive Units	4096 = 100% setpoint
Factory Default	+0.0 %
Minimum Value	-800%
Maximum Value	+800%

Over Setpoint 4
[Over Setpoint 4]

This parameter is used to specify the setpoint threshold for the Over Setpoint 4 bit in Logic Status HI.

Parameter Number	65
Parameter Type	Basic
Display Units	+/- x.x %
Drive Units	4096 = 100% setpoint
Factory Default	+0.0 %
Minimum Value	-800%
Maximum Value	+800%

Setpoint Select
[Setpoint Select]

This parameter makes a selection between actual speed or internal Iq current reference for the At/Over Setpoint parameters. Each Setpoint Status bit can be set for either option (0 = Actual Speed; 1 = Iq Reference).

Parameter Number	66
Parameter Type	Enhanced
Display Units	Bits
Drive Units	bit clear = speed, set = current
Factory Default	0000
Minimum Value	0000
Maximum Value	FFFF

Speed Setpoint Tolerance
[Spd Setpoint Tol]

This parameter establishes a hysteresis band around the At Setpoints. It will be used to determine when to update the Setpoint Bits in the Logic Status HI word, when configured for actual speed option.

Parameter Number	67
Parameter Type	Enhanced
Display Units	x.x rpm
Drive Units	4096 = BMS
Factory Default	base sp / 100
Minimum Value	0.0 rpm
Maximum Value	base speed /10

Current Setpoint Tolerance
[Cur Setpoint Tol]

This parameter establishes a hysteresis band around the Setpoints. It will be used to determine when to update the Setpoint Bits in the Logic Status word, when configured for commanded current option.

Parameter Number	68
Parameter Type	Enhanced
Display Units	x.x%
Drive Units	4096 = 100% Iq
Factory Default	2.0%
Minimum Value	0.0%
Maximum Value	20.0%

Zero Speed Tolerance
[Zero Speed Tol]

This parameter establishes a band around zero speed that will be used to determine when to update the At Zero Speed bit in the Logic Status LOW word.

Parameter Number	69
Parameter Type	Enhanced
Display Units	+/- x%
Drive Units	4096 = BMS
Factory Default	base sp / 100
Minimum Value	0.0 rpm
Maximum Value	8 x base sp

Chapter 5
Programming Parameters

GROUP NO. 05
DRIVE LOGIC

Logic Testpoint Data
[Logic Tspt Data]

This parameter contains the logic control testpoint data that has been selected by the Logic Testpoint Select parameter.

Parameter Number	70
Parameter Type	Basic
Display Units	Bits
Drive Units	Bits
Factory Default	0000 hex
Minimum Value	0000 hex
Maximum Value	FFFF hex

Logic Testpoint Select
[Logic Tspt Sel]

This parameter selects which internal location in the logic control software will become the testpoint value. The value based upon the select will be stored in the Logic Testpoint Data parameter. The internal locations of the logic control software accessible based on the select value are:

Parameter Number	71
Parameter Type	Enhanced
Display Units	x
Drive Units	
Factory Default	0
Minimum Value	0
Maximum Value	15

Select Value	Logic Access Point	Select Value	Logic Access Point
0	Zero	16	Diagnostic Inhibit bits
1	Logic State	17	Zero
2	Edge Filtered Logic Command	18	Zero
3	Logic Control Word	19	Adapter handshake counter
4	Flux Inhibit Conditions	20	Longest handshake count
5	Run Inhibit Conditions	21	Stop event – led state
6	Current Processor Command Word	22	Stop event – System mode register
7	Current Processor Status Word	23	Stop event – Fault stop command
8	Diagnostic Request Flag	24	Stop event – Powerup diagnostic status
9	Requested Torque Mode	25	Stop event – Nonconfigurable fault status
10	Contactorm Fault Flag	26	Stop event – Current Processor Config Fault Status
11	Zero	27	Stop event – Velocity Processor Config Fault Status
12	Zero	28	Stop event – Adapter fault status
13	Loss of CP Enable Acknowledge		
14	Stop Mode		
15	Stop Event		

Stop Dwell
[Stop Dwell]

This sets an adjustable dwell time before the drive disables speed and torque regulators when a stop has occurred.

Parameter Number	72
Parameter Type	Basic, Sink
Display Units	x.x sec.
Drive Units	Display units x 10
Factory Default	1.0 sec.
Minimum Value	0.0 sec
Maximum Value	10.0 sec

**GROUP NO. 06
DYNAMIC BRAKE**

Maximum Dynamic Brake Power
[DB Power]

This parameter defines the power rating for the optional Dynamic Brake resistor. This value is used to calculate the per unit R theta for the resistor.

Parameter Number	77
Parameter Type	Enhanced
Display Units	x Watts
Drive Units	x Watts
Factory Default	0 Watts
Minimum Value	0 Watts
Maximum Value	30,000 Watts

Maximum Dynamic Brake Temperature
[DB Temp]

This parameter defines the Maximum Temperature Rating for the optional Dynamic Brake resistor. This value is used to establish setpoints for setting and clearing a Brake Overtemperature fault condition.

Parameter Number	78
Parameter Type	Enhanced
Display Units	x deg
Drive Units	x deg
Factory Default	50 deg C
Minimum Value	50 deg C
Maximum Value	700 deg sec

Dynamic Brake Time Constant
[DB Time Const]

This parameter defines the thermal time constant for the Optional Dynamic Brake resistor. This value is used in the brake resistor thermal model to predict brake temperature as a function of regenerative power.

Parameter Number	79
Parameter Type	Enhanced
Display Units	x Sec
Drive Units	x Sec
Factory Default	10 sec
Minimum Value	10 sec
Maximum Value	600 sec

**GROUP NO. 07
DRIVE FAULT**

Powerup/Diagnostic Fault Status
[PwrUp Flt Status]

This word parameter indicates a fault condition which has been detected during power up or reset of the drive. When a bit is "1", the condition is true, otherwise the condition is false.

Parameter Number	80
Parameter Type	Basic
Display Units	Bits
Drive Units	Bits
Factory Default	0000 hex
Minimum Value	0000 hex
Maximum Value	FFFF hex

Bit	Condition
0	CP PROM Failure
1	CP Internal RAM Failure
2	CP External RAM Failure
3	CP Stack RAM Failure
4	CP/VP Dualport RAM Failure
8	VP PROM Failure
9	VP Internal RAM Failure
10	VP External RAM Failure
11	VP Stack RAM Failure
12	VP/CP Dualport RAM Failure
13	VP/AP Dualport Ram Failure
14	Base Drive EE Failure
15	Not Used

GROUP NO. 07
DRIVE FAULT

Non-configurable Fault Status
[Ncfg Flt Status]

This word parameter indicates fault conditions in the drive that Cannot be configured as warnings. When a bit is "1", the condition is true, otherwise the condition is false. Bits 0 – 3 are detected by hardware. Bits 4–15 are detected by software

Parameter Number	81
Parameter Type	Basic
Display Units	Bits
Drive Units	Bits
Factory Default	0000 hex
Minimum Value	0000 hex
Maximum Value	FFFF hex

Bit	Condition	Bit	Condition
0	DC Bus Overvoltage Trip	10	Analog Power Supply Tolerance
1	Transistor Desaturation	11	Autocommission or Transistor Diagnostic
2	Ground Fault Trip	12	Inverter Temperature Trip
3	Instantaneous Overcurrent Trip	13	Software Malfunction selected by VP
4	Adapter Comm Loss detected by CP	14	Reserved
5	Master/Slave Cable Loss	15	Reserved
6	Master/Slave Enable Timeout		
7	Reserved		
8	Adapter Comm Loss detected by VP		
9	Absolute Overspeed		

CP Configurable Fault Status
[CP Flt Status]

This word parameter indicates conditions detected by the Current Processor (CP) that has been configured to report as a Drive fault condition. Each configuration bit matches the bit definitions of Parameter 84, 86 and 87. When a bit is "1" the condition is true, otherwise the condition is false.

Parameter Number	82
Parameter Type	Basic
Display Units	Bits
Drive Units	Bits
Factory Default	0000 hex
Minimum Value	0000 hex
Maximum Value	FFFF hex

Bit	Condition
0	Bus Ridethrough Timeout
1	Bus Precharge Timeout
2	Bus Drop (150 volts)
3	Bus Undervoltage
4	Bus Ridethru Cycles > 5

VP Configurable Fault Status
[VP Flt Status]

This word parameter indicates conditions detected by the Velocity Processor (VP) that has been configured to report as a Drive fault condition. Each configuration bit matches the bit definitions of Parameter 85, 88 and 89. When a bit is "1" the condition is true, otherwise the condition is false.

Parameter Number	83
Parameter Type	Basic
Display Units	Bits
Drive Units	Bits
Factory Default	0000 hex
Minimum Value	0000 hex
Maximum Value	FFFF hex

Bit	Condition	Bit	Condition
0	Feedback Loss	14	Drive to Drive Communication Fault
1	Inverter Overtemp Pending	15	Inverter Overload Trip (IT)
2	Motor Overtemperature Tripped		
3	Motor Overload Pending (I ² T)		
4	Motor Overload Trip (I ² T)		
5	Motor Stalled		
6	External Fault		
7	Not Used		
8	Not Used		
9	Parameter Limit		
10	Math Limit		
11	Dynamic Brake Overtemperature		
12	AC Motor Contactor Failure		
13	Inverter Overload Pending (IT)		

**GROUP NO. 07
DRIVE FAULT**

CP Configurable Warning Status
[CP Warn Status]

This word parameter indicates conditions detected by the current processor (CP) that have been configured to report as a Drive Warning condition. Each configuration bit matches the bit definitions of parameters 82, 86 and 87. When a bit is set to "1" the corresponding condition in the Drive is true, otherwise it is false.

Bit	Condition
0	Bus Ridethrough Timeout
1	Bus Precharge Timeout
2	Bus Drop
3	Bus Undervoltage
4	Bus Drop Cycles > 5

Parameter Number	84
Parameter Type	Basic
Display Units	Bits
Drive Units	Bits
Factory Default	0000 hex
Minimum Value	0000 hex
Maximum Value	FFFF hex

VP Configurable Warning Status (bits)
[VP Warn Status]

This word parameter indicates conditions detected by the Velocity Processor (VP) that have been configured to report as a Drive warning condition. Each configuration bit matches the bit definitions of parameters 83, 88 and 89. When a bit is set to "1", the corresponding condition in the Drive is true, otherwise it is false.

Bit	Condition
0	Feedback Loss
1	Inverter Overtemp Pending
2	Motor Overtemperature Tripped
3	Motor Overload Pending (I ² T)
4	Motor Overload Trip (I ² T)
5	Motor Stalled
6	External Fault
7	Not Used
8	Not Used
9	Parameter Limit
10	Math Limit
11	Dynamic Brake Resistor Overtemperature
12	AC Motor Contactor Failure
13	Inverter Overload Pending (IT)

Parameter Number	85
Parameter Type	Basic
Display Units	Bits
Drive Units	Bits
Factory Default	0000 hex
Minimum Value	0000 hex
Maximum Value	FFFF hex

Bit	Condition
14	Drive to Drive Communication Fault
15	Inverter Overload Foldback (IT)

CP Fault/Warning Configuration Select
[CP Flt Warn Cfg]

This word parameter determines conditions detected by the Current Processor (CP) that will be reported as either a drive fault or drive warning condition. Each configuration bit matches the bit definitions of parameters 82, 84 and 87. When a bit is set to "1", the corresponding condition in the Drive will be reported as a FAULT, otherwise it is reported as a WARNING.

Bit	Condition
0	Bus Ridethrough Timeout
1	Bus Precharge Timeout
2	Bus Drop (150 volts)
3	Bus Undervoltage
4	Bus Drop Cycles > 5

Parameter Number	86
Parameter Type	Basic
Display Units	Bits
Drive Units	Bits
Factory Default	0003 hex
Minimum Value	0000 hex
Maximum Value	FFFF hex

GROUP NO. 07
DRIVE FAULT

CP Warning/None Configuration Select
 [CP Warn/None Cfg]

This word parameter determines conditions detected by the Current Processor (CP) that will be reported as either a drive fault or drive warning condition. Each configuration bit matches the bit definition of Parameter 82, 84 and 87. When a bit is set to "1", the corresponding condition in the Drive will be reported as a FAULT, otherwise the condition is reported as a WARNING.

Bit	Condition
0	Bus Ridethrough Timeout
1	Bus Precharge Timeout
2	Bus Drop (150 volts)
3	Bus Undervoltage
4	Bus Drop Cycles > 5

Parameter Number	87
Parameter Type	Basic
Display Units	Bits
Drive Units	Bits
Factory Default	001C hex
Minimum Value	0000 hex
Maximum Value	FFFF hex

VP Fault/Warning Configuration Select
 [VP Flt/Warn Cfg]

This word parameter determines conditions detected by the Velocity Processor (VP) that will be reported as either a drive FAULT or drive WARNING condition. Each configuration bit matches the bit definitions of Parameters 83, 85 and 89. When a bit is set to "1" the corresponding condition in the Drive will be reported as a FAULT, otherwise the condition is reported as a WARNING.

Bit	Condition
0	Feedback Loss
1	Inverter Overtemp Pending
2	Motor Overtemperature Tripped
3	Motor Overload Pending (I ² T)
4	Motor Overload Trip (I ² T)
5	Motor Stalled
6	External Fault
7	Not Used
8	Not Used
9	Parameter Limit
10	Math Limit
11	Dynamic Brake Overtemperature
12	AC Motor Contactor Failure
13	Inverter Overload Pending (IT)

Parameter Number	88
Parameter Type	Basic
Display Units	Bits
Drive Units	Bits
Factory Default	FFFF hex
Minimum Value	0000 hex
Maximum Value	FFFF hex

Bit	Condition
14	Drive to Drive Communication Fault
15	Inverter Overload Trip (IT)

GROUP NO. 07
DRIVE FAULT

VP Warning/None Configuration Select
[VP Warn/None Cfg]

This parameter determines conditions detected by the Velocity Processor (VP) that will be reported as either a drive FAULT or WARNING or not reported (ignored). Each configuration bit matches the bit definitions of Parameters 83, 85 and 88. When a bit is set to "1", the corresponding condition in the Drive will be reported as configured by parameter 88. If the bit is set to "0", the condition is not reported.

Parameter Number	89
Parameter Type	Basic
Display Units	Bits
Drive Units	Bits
Factory Default	0000 hex
Minimum Value	FFFF hex
Maximum Value	FFFF hex

Bit	Condition	Bit	Condition
0	Feedback Loss	14	Drive to Drive Communication Fault
1	Inverter Overtemp	15	Inverter Overload Trip (IT)
2	Motor Overtemperature		
3	Motor Overload Pending (I ² T)		
4	Motor Overload Trip (I ² T)		
5	Motor Stalled		
6	External Fault		
7	Not Used		
8	Not Used		
9	Parameter Limit		
10	Math Limit		
11	Dynamic Brake Overtemperature		
12	AC Motor Contactor Failure		
13	Inverter Overload Pending (IT)		

Absolute Overspeed Threshold
[Absolute Overspd]

This parameter indicates the incremental speed above Forward Speed Limit or Reverse Speed Limit that is allowable before an Absolute Overspeed Fault is indicated.

Parameter Number	90
Parameter Type	Basic
Display Units	x.x rpm
Drive Units	4096 = 100% overspeed
Factory Default	0.1 x base speed
Minimum Value	0.0 rpm
Maximum Value	base speed

Stall Delay
[Stall Delay]

This parameter specifies the amount of time that the Drive must be in current limit and at zero speed before a Stall Fault will be indicated.

Parameter Number	91
Parameter Type	Basic
Display Units	x.x sec.
Drive Units	sec. x 10
Factory Default	1.0 sec
Minimum Value	0.1 sec
Maximum Value	3276.7 sec

Motor Overload Limit
[Overload Limit]

This parameter specifies the level of Iq current that will cause a Motor Overload Trip after 60 seconds.

Parameter Number	92
Parameter Type	Enhanced
Display Units	xxx%
Drive Units	4096 = 100% Iq for 60 sec.
Factory Default	200%
Minimum Value	150%
Maximum Value	400%

Transistor Rjc
[Transistor Rjc]

This parameter is used by the power transistor protection limit algorithm. It sets the rise above the transistor heatsink temperature for the internal junction temperature within the power transistor devices.

Parameter Number	93
Parameter Type	Enhanced
Display Units	x deg
Drive Units	Deg. C @ 100% Inv Current
Factory Default	30 deg c
Minimum Value	17 deg C
Maximum Value	35 deg C

Chapter 5
Programming Parameters

GROUP NO. 07
DRIVE FAULT

<p>Motor Overtemp Limit [Mtr Overtemp Lmt]</p> <p>This parameter establishes the temperature setpoint upper limit. Above this limit a Motor Overtemperature fault will occur. This setpoint will be compared against the motor overtemperature as read from the RTD device</p>	<table border="1"> <tbody> <tr> <td>Parameter Number</td> <td>94</td> </tr> <tr> <td>Parameter Type</td> <td>Enhanced</td> </tr> <tr> <td>Display Units</td> <td>x deg.</td> </tr> <tr> <td>Drive Units</td> <td>x deg.</td> </tr> <tr> <td>Factory Default</td> <td>0 deg C</td> </tr> <tr> <td>Minimum Value</td> <td>0 deg C</td> </tr> <tr> <td>Maximum Value</td> <td>250 deg C</td> </tr> </tbody> </table>	Parameter Number	94	Parameter Type	Enhanced	Display Units	x deg.	Drive Units	x deg.	Factory Default	0 deg C	Minimum Value	0 deg C	Maximum Value	250 deg C
Parameter Number	94														
Parameter Type	Enhanced														
Display Units	x deg.														
Drive Units	x deg.														
Factory Default	0 deg C														
Minimum Value	0 deg C														
Maximum Value	250 deg C														
<p>Overload Speed 1 [Overload Speed 1]</p> <p>If the absolute value of motor speed is at or below the speed specified in this parameter, the motor overload will use the overload breakpoint min current (parameter #97) as its minimum current trip level.</p>	<table border="1"> <tbody> <tr> <td>Parameter Number</td> <td>95</td> </tr> <tr> <td>Parameter Type</td> <td>Enhanced</td> </tr> <tr> <td>Display Units</td> <td>+/- x.x rpm</td> </tr> <tr> <td>Drive Units</td> <td>4096 = base motor speed</td> </tr> <tr> <td>Factory Default</td> <td>0.8 x base speed</td> </tr> <tr> <td>Minimum Value</td> <td>0.0 rpm</td> </tr> <tr> <td>Maximum Value</td> <td>2 x base speed</td> </tr> </tbody> </table>	Parameter Number	95	Parameter Type	Enhanced	Display Units	+/- x.x rpm	Drive Units	4096 = base motor speed	Factory Default	0.8 x base speed	Minimum Value	0.0 rpm	Maximum Value	2 x base speed
Parameter Number	95														
Parameter Type	Enhanced														
Display Units	+/- x.x rpm														
Drive Units	4096 = base motor speed														
Factory Default	0.8 x base speed														
Minimum Value	0.0 rpm														
Maximum Value	2 x base speed														
<p>Overload Speed 2 [Overload Speed 2]</p> <p>If the absolute value of motor speed is at or above the speed specified in this parameter, the motor overload will use 100% as its minimum Iq trip level.</p>	<table border="1"> <tbody> <tr> <td>Parameter Number</td> <td>96</td> </tr> <tr> <td>Parameter Type</td> <td>Enhanced</td> </tr> <tr> <td>Display Units</td> <td>+/- x.x rpm</td> </tr> <tr> <td>Drive Units</td> <td>4096 = base motor speed</td> </tr> <tr> <td>Factory Default</td> <td>0.8 x base speed</td> </tr> <tr> <td>Minimum Value</td> <td>0.0 rpm</td> </tr> <tr> <td>Maximum Value</td> <td>2 x base speed</td> </tr> </tbody> </table>	Parameter Number	96	Parameter Type	Enhanced	Display Units	+/- x.x rpm	Drive Units	4096 = base motor speed	Factory Default	0.8 x base speed	Minimum Value	0.0 rpm	Maximum Value	2 x base speed
Parameter Number	96														
Parameter Type	Enhanced														
Display Units	+/- x.x rpm														
Drive Units	4096 = base motor speed														
Factory Default	0.8 x base speed														
Minimum Value	0.0 rpm														
Maximum Value	2 x base speed														
<p>Minimum Overload Limit [Min Overload Limit]</p> <p>If the absolute value of motor speed is at or above the speed specified in breakpoint speed 2 (parameter 96), the motor overload will use 100% as its minimum Iq trip level.</p>	<table border="1"> <tbody> <tr> <td>Parameter Number</td> <td>97</td> </tr> <tr> <td>Parameter Type</td> <td>Enhanced</td> </tr> <tr> <td>Display Units</td> <td>xxx%</td> </tr> <tr> <td>Drive Units</td> <td>4096 = 100% Iq for 60 sec.</td> </tr> <tr> <td>Factory Default</td> <td>20% Iq</td> </tr> <tr> <td>Minimum Value</td> <td>0% Iq</td> </tr> <tr> <td>Maximum Value</td> <td>100% Iq</td> </tr> </tbody> </table>	Parameter Number	97	Parameter Type	Enhanced	Display Units	xxx%	Drive Units	4096 = 100% Iq for 60 sec.	Factory Default	20% Iq	Minimum Value	0% Iq	Maximum Value	100% Iq
Parameter Number	97														
Parameter Type	Enhanced														
Display Units	xxx%														
Drive Units	4096 = 100% Iq for 60 sec.														
Factory Default	20% Iq														
Minimum Value	0% Iq														
Maximum Value	100% Iq														
<p>Fault Testpoint Data [Fault TP]</p> <p>This parameter contains the fault control testpoint data that has been selected by the Fault Testpoint Select parameter(P99). See the description for the Fault Testpoint Select parameter 99 for a list of possible testpoints.</p>	<table border="1"> <tbody> <tr> <td>Parameter Number</td> <td>98</td> </tr> <tr> <td>Parameter Type</td> <td>Basic</td> </tr> <tr> <td>Display Units</td> <td>x</td> </tr> <tr> <td>Drive Units</td> <td>x</td> </tr> <tr> <td>Factory Default</td> <td>0</td> </tr> <tr> <td>Minimum Value</td> <td>0</td> </tr> <tr> <td>Maximum Value</td> <td>65535</td> </tr> </tbody> </table>	Parameter Number	98	Parameter Type	Basic	Display Units	x	Drive Units	x	Factory Default	0	Minimum Value	0	Maximum Value	65535
Parameter Number	98														
Parameter Type	Basic														
Display Units	x														
Drive Units	x														
Factory Default	0														
Minimum Value	0														
Maximum Value	65535														

**GROUP NO. 07
DRIVE FAULT**

Fault Testpoint Select
[Fault TP]

This parameter selects which internal location in the fault control software will become the testpoint value. The value based upon the select will be stored in the Fault Testpoint Data parameter 98. The internal locations of the logic control software that are accessible based on the select value are listed below:

Parameter Number	99
Parameter Type	Basic
Display Units	x
Drive Units	x
Factory Default	0
Minimum Value	0
Maximum Value	30

Select Value

Velocity Reference Access Point

0	Zero
1	Adapter Processor Faulted
2	Actual Velocity when Overspeed occurred
3	Motor Overload Calibration Constant (K)
4	Heatsink NTC Analog Input Voltage
5	Heatsink NTC Foldback Current Limit
6	Negative Analog Supply A/O input voltage
7	Positive Analog Supply A/O input Voltage
8	Motor RTD Analog Input Voltage
9	Motor Overload Integrator(I ² T) level
10	Dynamic Brake Resistor Temperature, Degrees C.
11	Parameter Limit Status, Word 1
12	Parameter Limit Status, Word 2
13	Velocity Reference Math Overflow Status
14	Velocity Feedback Math Overflow Status
15	Velocity Regulator Math Overflow Status
16	Torque Reference Math Overflow Status
17	Process Trim Math Overflow Status

Select Value

26
27
28
29

Velocity Ref Access Point

Drive to Drive fault status
Base Drive EE fault status
Base Drive EE drive type address
Base Drive EE drive type data

VELOCITY Feedback Error Conditions:

18	Acceleration Error
19	Illegal State Edge Samples
20	Illegal State Level
21	Encoder Loss Edge Samples
22	Encoder Loss Level
23	Iq Reference in per unit Inverter Units
24	Motor Overload Integrator Output Level (IT)
25	Motor Temperature, Degrees C.

**GROUP NO. 08
VELOCITY
REFERENCE**

Velocity Reference 1 LOW (Fraction)
[Vel Ref 1 Low]

This word supplies the fractional part of the external velocity reference 1 when external velocity control has been selected in the Logic Command Word.

Parameter Number	100
Parameter Type	Basic
Display Units	x
Drive Units	
Factory Default	0
Minimum Value	0
Maximum Value	65535

GROUP NO. 08
VELOCITY
REFERENCE

<p>Velocity Reference 1 HI (Whole 32 bit) [Vel Ref 1 Hi]</p> <p>This word supplies the whole number part of external velocity reference 2 when the external velocity control has been selected in the Logic Command Word.</p>	<p>Parameter Number 101 Parameter Type Basic Display Units +/- X.x rpm Drive Units 4096 = BMS Factory Default + 0.0 rpm Minimum Value - 8 x base sp Maximum Value +8 x base sp</p>
<p>Velocity Scale Factor 1 [Vel Scale Fctr 1]</p> <p>This parameter sets the gain multiplier that will be used to scale velocity reference 1.</p>	<p>Parameter Number 102 Parameter Type Basic Display Units +/- x.xxxx Drive Units 8192 = 1.0 gain Factory Default + 1.0000 Minimum Value - 4.0000 Maximum Value + 4.0000</p>
<p>Velocity Reference 2 LOW (Fraction) [Vel Ref 2 Low]</p> <p>This word supplies the fractional part of the external velocity reference 2 when the external velocity control has been selected in the Logic Command word.</p>	<p>Parameter Number 103 Parameter Type Enhanced Display Units x Drive Units x Factory Default 0 Minimum Value 0 Maximum Value 65535</p>
<p>Velocity Reference 2 HI (Whole 32 bit) [Precharg Timeout]</p> <p>This word supplies the whole number reference 2 when the external velocity control has been selected in the Logic Command word.</p>	<p>Parameter Number 104 Parameter Type Enhanced Display Units +/- x.x rpm Drive Units x Factory Default + 0.0 rpm Minimum Value - 8 x base sp Maximum Value + 8 x base sp</p>
<p>Velocity Scale Fctr 2 [Vel Scale Fctr 2]</p> <p>This parameter sets the gain multiplier that will be used to scale velocity reference 2.</p>	<p>Parameter Number 105 Parameter Type Enhanced Display Units +/- x.xxxx Drive Units 8192 = 1.0 gain Factory Default +1.0000 Minimum Value -4.0000 Maximum Value +4.0000</p>
<p>Velocity Trim LOW [Vel Trim Low]</p> <p>This word supplies the fractional number part of a 32 bit velocity reference trim.</p>	<p>Parameter Number 106 Parameter Type Enhanced Display Units x.xx Sec. Drive Units x.xx Sec. Factory Default 0 Minimum Value 0 Maximum Value 65535</p>
<p>Velocity Trim Hi (32 bit) [Vel Trim Hi]</p> <p>This word supplies the whole number part of a 32 bit velocity reference trim.</p>	<p>Parameter Number 107 Parameter Type Enhanced Display Units +/- x.x rpm Drive Units x Factory Default 0.0 rpm Minimum Value - 8 x base sp Maximum Value + 8 x base sp</p>

GROUP NO. 08
VELOCITY
REFERENCE

Velocity Reference Testpoint Data LOW
[Vel Ref TP Low]

This parameter indicates the LOW of the 32 bit value of the internal location selected by the Velocity Reference Testpoint Select parameter.

Parameter Number	108
Parameter Type	Basic
Display Units	x
Drive Units	1 = 1/2^28 base motor speed
Factory Default	0u
Minimum Value	0u
Maximum Value	65535u

Velocity Reference Testpoint Data HI (32 bit)
[Vel Ref TP Hi]

This parameter indicates the HI 32 bit value of the internal location selected by the Velocity Reference Testpoint Select parameter.

Parameter Number	109
Parameter Type	Basic
Display Units	+/- x.x rpm
Drive Units	4096 = base motor speed
Factory Default	+0.0 rpm
Minimum Value	-8 x base speed rpm
Maximum Value	+8 x base speed rpm

Velocity Reference Testpoint Select
[Vel Ref TP Sel]

This parameter selects which internal location of the velocity reference will become the testpoint value. The following are the internal locations based upon the select value:

Parameter Number	110
Parameter Type	Basic
Display Units	x
Drive Units	x
Factory Default	0
Minimum Value	0
Maximum Value	12

Select Value	Velocity Reference Access Point
0	Zero
1	Limit Status (HI)
2	Reference Selection (LOW)
3	Selected Reference (HI, LOW)
4	Limited Reference (HI, LOW)
5	Direction Selected Ref (HI, LOW)
6	Fwd Speed Limit (HI)
7	Rev Speed Limit (LOW)
8	Ramp Input (HI, LOW)
9	Ramp Input (HI, LOW)
10	Velocity Trim Sum (HI, LOW)
11	Internal Velocity Trim (HI, LOW)
12	Trimmed Velocity Reference (HI, LOW)
	Maximum Frequency Limit (HI); Zero (LOW)
	Reference after Trim Limit (HI, LOW)

Jog Speed 1
[Jog Speed 1]

This will be the velocity reference used by the Drive when Jog 1 has been selected in the Logic Command word.

Parameter Number	117
Parameter Type	Basic
Display Units	+/- x.x rpm
Drive Units	4096 = BMS
Factory Default	+0.0 rpm
Minimum Value	-8 x rpm
Maximum Value	+8 x rpm

Jog Speed 2
[Jog Speed 2]

This will be the velocity reference used by the Drive when Jog 2 has been selected in the Logic Command word.

Parameter Number	118
Parameter Type	Basic
Display Units	+/- x%
Drive Units	4096 = BMS
Factory Default	+ 0.0 rpm
Minimum Value	-8 x rpm
Maximum Value	+8 x rpm

GROUP NO. 08
VELOCITY
REFERENCE

Preset Speed 1

[Preset Speed 1]

This will be the velocity reference used by the Drive when preset 1 has been selected in the Logic Command word.

Parameter Number	119
Parameter Type	Basic
Display Units	+/- x.x rpm
Drive Units	4096 = BMS
Factory Default	+0.0 rpm
Minimum Value	-8 x base speed
Maximum Value	+8 x base speed

Preset Speed 2

[Preset Speed 2]

This will be the velocity reference used by the Drive when preset 2 has been selected in the Logic Command word.

Parameter Number	120
Parameter Type	Basic
Display Units	+/- x.x rpm
Drive Units	4096 = BMS
Factory Default	+0.0 rpm
Minimum Value	-8 x base speed
Maximum Value	+8 x base speed

Preset Speed 3

[Preset Speed 3]

This will be the velocity reference used by the Drive when preset 3 has been selected in the Logic Command word.

Parameter Number	121
Parameter Type	Enhanced
Display Units	+/- x.x rpm
Drive Units	4096 = BMS
Factory Default	+0.0 rpm
Minimum Value	-8 x base speed
Maximum Value	+8 x base speed

Preset Speed 4

[Preset Speed 4]

This will be the velocity reference used by the Drive when preset 4 has been selected in the Logic Command word.

Parameter Number	122
Parameter Type	Basic
Display Units	+/- x.x rpm
Drive Units	4096 = BMS
Factory Default	+0.0 rpm
Minimum Value	-8 x base speed
Maximum Value	+8 x base speed

Preset Speed 5

[Preset Speed 5]

This will be the velocity reference used by the Drive when preset 5 has been selected in the Logic Command word.

Parameter Number	123
Parameter Type	Basic
Display Units	+/- x.x rpm
Drive Units	4096 = BMS
Factory Default	+0.0 rpm
Minimum Value	-8 x base speed
Maximum Value	+8 x base speed

Accel Time

[Accel Time]

This parameter determines the acceleration rate of the velocity reference for all references. Units are measured in seconds to accelerate from 0 to base speed. This function can be bypassed by setting bit 9 in the Logic Command word.

Parameter Number	125
Parameter Type	Basic, Sink
Display Units	x.x Sec.
Drive Units	Display units x 10
Factory Default	10.0 sec.
Minimum Value	0.1 sec.
Maximum Value	6553.5 sec

Decel Time

[Decel Time]

This parameter determines the deceleration rate of the velocity reference for all references. Units are measured in seconds to decelerate from base speed to 0. This function can be bypassed by setting bit 9 in the Logic Command word.

Parameter Number	126
Parameter Type	Basic, Sink
Display Units	x.x Sec.
Drive Units	Display units x 10
Factory Default	10.0 sec.
Minimum Value	0.1 sec
Maximum Value	6553.5 sec

GROUP NO. 08
VELOCITY
REFERENCE

<p>Reverse Motor Speed Limit [Rev Speed Limit]</p> <p>This parameter sets a limit on velocity in the negative direction. The value entered must be Negative or Zero. The numeric range of this parameter is 0 to -6 times base motor speed.</p>	<p>Parameter Number Parameter Type Display Units Drive Units Factory Default Minimum Value Maximum Value</p>	<p>127 Basic, Sink - x.x rpm - 4096 @ Base Motor Speed - 4096 - 24576 + 0.0 rpm</p>
<p>Forward Motor Speed Limit [Fwd Speed Limit]</p> <p>This parameter sets a limit on velocity in the positive direction. The value entered must be Positive or Zero. The numeric range of this parameter is +6 x base speed rpm.</p>	<p>Parameter Number Parameter Type Display Units Drive Units Factory Default Minimum Value Maximum Value</p>	<p>128 Basic, Sink x.x rpm + 4096 @ Base Motor Speed 4096 + 0.0 rpm 24576</p>
<p>Maximum Reverse Speed Trim [Max Rev Spd Trim]</p> <p>This parameter limits the minimum value of the velocity reference after the process trim output and the external velocity trim has been added.</p>	<p>Parameter Number Parameter Type Display Units Drive Units Factory Default Minimum Value Maximum Value</p>	<p>129 Enhanced +/- x.x rpm -4096 = BMS - base speed - 6 x base speed + 6 x base speed</p>
<p>Maximum Forward Speed Trim [Max Fwd Spd Trim]</p> <p>This parameter limits the maximum value of the velocity reference after the process trim.</p>	<p>Parameter Number Parameter Type Display Units Drive Units Factory Default Minimum Value Maximum Value</p>	<p>130 Enhanced +/- x.x rpm 4096 = BMS + base speed + 0.0 rpm + 6 x base speed</p>
<p>Droop Percent [Droop Percent]</p> <p>This parameter specifies the percent of base speed that the velocity reference will be reduced when at full load torque. This feature can be used to cause motor velocity to droop with an increase in load.</p>	<p>Parameter Number Parameter Type Display Units Drive Units Factory Default Minimum Value Maximum Value</p>	<p>131 Enhanced, Sink x.x% Display units X 10 0% 0% 25.5%</p>
<p>Velocity Reference Output LOW [Vel Ref Out Low]</p> <p>This is the low word portion of a 32 bit velocity reference quantity. It is the input term for the Velocity PI Regulator.</p>	<p>Parameter Number Parameter Type Display Units Drive Units Factory Default Minimum Value Maximum Value</p>	<p>132 Enhanced x 0 0 65536</p>
<p>Velocity Reference Output HI (32 bit) [Vel Ref Out High]</p> <p>This is the high word portion of a 32 bit velocity reference quantity. It is the input term for the Velocity PI Regulator.</p>	<p>Parameter Number Parameter Type Display Units Drive Units Factory Default Minimum Value Maximum Value</p>	<p>133 Enhanced +/- x.x rpm 4096 = BMS +0.0 rpm - 8 x base sp + 8 x base sp</p>

GROUP NO. 09
VELOCITY
REGULATOR

Velocity Regulator Output

[Vel Reg Output]

This parameter represents the torque reference value that appears at the output of the Velocity PI Regulator. It is the input to the torque mode selector and is used as the drive's torque reference value when in torque mode 1.

Parameter Number	134
Parameter Type	Enhanced
Display Units	+/- x.x %
Drive Units	4096 = 100% Iq motor
Factory Default	+ 0.0 %
Minimum Value	- 300%
Maximum Value	+300%

Velocity Regulator Testpoint Data LOW

[Vel Reg TP Low]

This parameter indicates the value of the internal location selected by the Velocity Regulator Testpoint Select parameter. The select allows this parameter to be used as a testpoint for the velocity regulator.

Parameter Number	135
Parameter Type	Enhanced
Display Units	x
Drive Units	x
Factory Default	0
Minimum Value	0
Maximum Value	65535

Velocity Regulator Testpoint Data HI (32 bit)

[Vel Reg TP Hi]

This parameter indicates the value of the internal location selected by the Velocity Regulator Testpoint Select parameter. The select allows this parameter to be used as a testpoint for the velocity regulator.

Parameter Number	136
Parameter Type	Enhanced
Display Units	+/-x
Drive Units	x
Factory Default	0
Minimum Value	-32767
Maximum Value	+32767

Velocity Regulator Testpoint Select

[Vel Reg TP Sel]

This parameter selects which internal location of the velocity reference will become the testpoint value. The following are the internal locations based upon the select value:

Parameter Number	137
Parameter Type	Enhanced
Display Units	x
Drive Units	x
Factory Default	0
Minimum Value	0
Maximum Value	15

Select Value	Velocity Reference Access Point
0	Zero
1	Droop Speed Offset (32bit)
2	Drooped Velocity Reference (32 bit)
3	Kf Term (Low), Kf Err (High)
4	Kf Error Filter Output 1 (Low), Kf Error Filter Output 2 (High)
5	Kp Term (32 bit)
6	Qr - 1st 16 bit (Low), 2nd 16 bit (High)
7	Qr - 3rd 16 bit (Low), 4th 16 bit (High)
8	Qf - 1st 16 bit (Low), 2nd 16 bit (High)
9	Qf - 3rd 16 bit (Low), 4th 16 bit (High)
10	Qe - 1st 16 bit (Low), 2nd 16 bit (High)
11	Qe - 3rd 16 bit (Low), Not Used (High)
12	Qec1 - 1st 16 bit (Low), 2nd 16 bit (High)
13	Qec1 - 3rd 16 bit (Low), 4th 16 bit (High)
14	Ki Term (32 bit)
15	Logic Control Word (LOW) Integrator Enable Flag (HIGH)

Velocity Error

[Velocity Error]

This parameter contains a value that is the difference between the whole number portion of the velocity regulator's reference input and the velocity feedback.

Parameter Number	138
Parameter Type	Enhanced
Display Units	+/- x.x rpm
Drive Units	4096 = base motor speed
Factory Default	+0.0 rpm
Minimum Value	- 8 x base speed rpm
Maximum Value	+8 x base speed rpm

GROUP NO. 09
VELOCITY
REGULATOR

<p>KI – Velocity Loop [Ki Velocity Loop]</p> <p>This parameter controls the integral error gain of the velocity regulator. Gain has a resolution of 1/8, therefore a Ki gain of 1.0 is converted to internal drive units as a value of 8.</p>	<p>Parameter Number 139 Parameter Type Basic, Sink Display Units x.x Drive Units Display units x 8 Factory Default 32.0 Minimum Value 0.0 Maximum Value 4096.0</p>
<p>KP – Velocity Loop [Kp Velocity Loop]</p> <p>This parameter controls the proportional error gain of the velocity regulator. Gain has a resolution of 1/8, therefore a gain of 1.0 is converted to internal drive units as a value of 8.</p>	<p>Parameter Number 140 Parameter Type Basic, Sink Display Units x.x Drive Units Display units x 8 Factory Default 8.0 Minimum Value 0.0 Maximum Value 200.0</p>
<p>KF – Velocity Loop [Kf Velocity Loop]</p> <p>This parameter controls the feed forward gain of the velocity regulator. Setting the Kf gain to less than one reduces velocity feedback overshoot in response to a step change in velocity reference.</p>	<p>Parameter Number 141 Parameter Type Basic, Sink Display Units x.xx Drive Units Display units x 65535 Factory Default 1.00 Minimum Value 0.50 Maximum Value 1.00</p>
<p>KF Error Filter Bandwidth [Error Filter BW]</p> <p>This parameter sets the bandwidths of two cascaded low pass filters in the Kf error path of the Velocity PI Regulator. Bandwidth is entered in units of radians per second.</p>	<p>Parameter Number 142 Parameter Type Basic, Sink Display Units x R/S Drive Units X Factory Default 500 rad/s Minimum Value –1500 rad/s Maximum Value 1500 rad/s</p>

GROUP NO. 10
VELOCITY
FEEDBACK

<p>Velocity Feedback Testpoint Data LOW [Vel Fdbk TP Low]</p> <p>This parameter contains the LOW part of the 32 bit value of the internal location selected by the Velocity Feedback</p>	<p>Parameter Number 143 Parameter Type Basic Display Units +/- x Drive Units +/- x Factory Default 0u Minimum Value 0u Maximum Value 65535u</p>
<p>Velocity Feedback Testpoint Data HI (32 bit) [Vel Fdbk TP Hi]</p> <p>This parameter contains the HIGH part of the 32 bit value of the internal location selected by the Velocity Feedback</p>	<p>Parameter Number 144 Parameter Type Basic Display Units +/- x Drive Units +/- x Factory Default +0 Minimum Value –32767 Maximum Value +32767</p>

GROUP NO. 10
VELOCITY
FEEDBACK

<p>Velocity Feedback Testpoint Select [Vel Fdbk TP Sel]</p> <p>This parameter selects which internal location of the velocity reference will become the testpoint value. The value based upon the select will be stored in the Velocity Feedback Testpoint Data parameter.</p>	<p>Parameter Number 145 Parameter Type Basic Display Units x Drive Units x Factory Default 0 Minimum Value 0 Maximum Value 16</p>
<p>Select Value Feedback Access Point</p> <p>0 Zero</p> <p>1 Encoder Velocity (Low), Zero (High)</p> <p>2 Selected Velocity (Low), Difference Velocity (High)</p> <p>3 2 msec Scan Interval (Low), Zero (High)</p> <p>4 Edge Pulse Count (Low), Zero (High)</p> <p>5 Acceleration (Low), Acceleration Error (High)</p> <p>6 Edges Moved Count (Low), Zero (High)</p> <p>7 Delta Theta (32 bit)</p> <p>8 Count Direction (Low), Status Bits (High)</p> <p>9 Edge to Edge Time (Low), Zero (High)</p> <p>10 Equal Area Intervals (Low), Zero (High)</p> <p>11 Empty Intervals (Low), Zero (High)</p> <p>12 Active Feedback Device</p> <p>13 Limit Status (Low), Zero (High)</p> <p>14 Qf - 1st 16 bit (Low), 2nd 16 bit (High)</p> <p>15 Qf - 3rd 16 bit (Low), Not Used (High)</p> <p>16 Velocity with Slow Filter (Low), Not Used (High)</p>	
<p>Velocity Feedback [Vel Feedback]</p> <p>This parameter indicates the latest measured motor velocity information from a feedback device (Tach, encoder etc.) The value is taken at the output of the selectable feedback filters.</p>	<p>Parameter Number 146 Parameter Type Basic, Source Display Units +/- x.x rpm Drive Units 4096 @ Base Motor Speed Factory Default +0.0 rpm Minimum Value -32767 Maximum Value +32767</p>
<p>Scaled Velocity Feedback [Scaled Vel Fdbk]</p> <p>This parameter is a rescaled version of velocity feedback from parameter 146. The inverse of either Velocity Scale Factor 1 or 2 is used.</p>	<p>Parameter Number 147 Parameter Type Basic, Source Display Units x+/- x Drive Units x+/- x Factory Default 0 Minimum Value -32767 Maximum Value +32767</p>
<p>Encoder Position Feedback LOW [Enc Pos Fdbk Low]</p> <p>This is the LOW word portion of a 32 bit encoder pulse accumulator. Each encoder quadrature edge will be counted, resulting in a 4X multiplication. As a result, this parameter will be scaled such that the position change per motor revolution is equal to 4 times the encoder PPR.</p>	<p>Parameter Number 148 Parameter Type Enhanced Display Units x Drive Units x Factory Default 0 Minimum Value 0 Maximum Value 65535u</p>
<p>Encoder Position Feedback HI [Enc Pos Fdbk Hi]</p> <p>This is the HI word portion of a 32 bit encoder pulse accumulator that was described for the previous parameter. This word will change by 1 count for every change in low count of 65,536 4X encoder pulses.</p>	<p>Parameter Number 149 Parameter Type Enhanced Display Units x Drive Units x Factory Default 0 Minimum Value 0 Maximum Value 65535u</p>

GROUP NO. 10
VELOCITY
FEEDBACK

<p>Feedback Device Type [Fdbk Device Type]</p> <p>This parameter selects the source for motor velocity feedback: 0 – Encoder Feedback 1 – Encoder Feedback 2 – Encoder Feedback w/tracker filter 3 – Motor Simulation 4 – Reserved 5 – External Feedback (Test Appl)</p>	<p>Parameter Number 150 Parameter Type Basic, Sink Display Units x Drive Units x Factory Default Encoder Minimum Value None Maximum Value External Velocity</p>
<p>Feedback Tracker Gain [Fdbk Track Gain]</p> <p>Affects gain of the alpha-beta tracker filter used when Feedback Device Type = 2. Smaller gains result in increased filtering. Typical Value: = 0.15 to 0.7 Use 1.0 to disable.</p>	<p>Parameter Number 151 Parameter Type Enhanced, Sink Display Units x.xxx Drive Units 1024 @ 1.000 gain Factory Default 1.000 Minimum Value 0.043 Maximum Value 1.000</p>
<p>Feedback Filter Select [Fdbk Filter Sel]</p> <p>0 = No Filter 1 = "light" 35/49 radian feedback filter 2 = "heavy" 20/40 radian feedback filter 3 = Single pole Lead Lag feedback filter 4 = Reserved (No Filter)</p>	<p>Parameter Number 152 Parameter Type Enhanced, Sink Display Units x Drive Units x Factory Default 0 Minimum Value 0 Maximum Value 4</p>
<p>Kn – Feedback Filter Gain [Fdbk Filter Gain]</p> <p>This is the Kn term of the single pole lead/lag feedback filter. Kn greater than 1.0 will produce a lead filter, and less than 1.0 a lag filter. Kn equal to 1.0 will disable the feedback filter.</p>	<p>Parameter Number 153 Parameter Type Enhanced, Sink Display Units +/- x.xx Drive Units 256 = 1.0 gain Factory Default +1.00 Minimum Value -5.00 Maximum Value +5.00</p>
<p>Wn – Feedback Filter Bandwidth [Fdbk Filter BW]</p> <p>This parameter establishes the breakpoint radian frequency for the velocity feedback lead-lag filter.</p>	<p>Parameter Number 154 Parameter Type Enhanced, Sink Display Units x R/S Drive Units x Factory Default 100 r/s Minimum Value 1 r/s Maximum Value 900 r/s</p>
<p>Tach Velocity [Tach Velocity]</p> <p>This word supplies a motor velocity feedback signal when a source other than an encoder is used. This input will typically be linked to an analog input parameter from the adapter board.</p>	<p>Parameter Number 155 Parameter Type Enhanced Display Units +/- x.xx rpm Drive Units 4096 = BMS Factory Default 0.0 rpm Minimum Value -8 x base speed Maximum Value +8 x base speed</p>

GROUP NO. 11
TORQUE
REFERENCE

External Iq Reference
[External Iq Ref]

This parameter supplies an external Iq reference to the Drive. The external Iq reference is summed with the internal Iq reference just prior to the current limiter.

Parameter Number	161
Parameter Type	Enhanced
Display Units	+/- x.x %
Drive Units	4096 = 100% Iq motor
Factory Default	+0.0%
Minimum Value	-800.0%
Maximum Value	+800.0%

External Torque Reference 1
[Ext Torque Ref 1]

This word supplies an external motor torque reference to the Drive. The external torque reference can be selected by setting the Torque Mode Select parameter (Parm 53) to a value of "2".

Parameter Number	162
Parameter Type	Basic
Display Units	+/- x.x %
Drive Units	4096 = Rated Torque
Factory Default	+0.0%
Minimum Value	-800%
Maximum Value	+800%

Slave Torque Percent 1
[Slave Torque % 1]

External Torque Reference 1 is multiplied by a gain that is specified by this parameter. This multiplier is scaled so that 4096 represents a gain of 1.0 (100%)

Parameter Number	163
Parameter Type	Basic
Display Units	+/- x.xx%
Drive Units	4096 = 1.0 gain
Factory Default	+100%
Minimum Value	-200%
Maximum Value	+200%

External Torque Reference 2
[Ext Torq Ref 2]

This word supplies an external motor torque reference to the Drive. The External Torque Reference can be selected by setting the Torque Mode Select parameter (Parm 53) to a value of "2".

Parameter Number	164
Parameter Type	Enhanced
Display Units	+/- x.x%
Drive Units	4096 = rated torque
Factory Default	+0.0%
Minimum Value	-800.0%
Maximum Value	+800.0%

Slave Torque Percent 2
[Slave Torque % 2]

External Torque Reference 2 is multiplied by a gain that is specified by this parameter. This multiplier is scaled so that 4096 represents a gain of 1.0 (100%)

Parameter Number	165
Parameter Type	Enhanced
Display Units	+/- x.x %
Drive Units	4096 = 1.0 gain
Factory Default	+0.0 %
Minimum Value	-800%
Maximum Value	+800%

External Torque Step
[Ext Torque Step]

This parameter supplies an external torque offset to the Drive. The External Torque Step is summed with the Torque Mode Selector output prior to the Torque Limiter.

Parameter Number	166
Parameter Type	Enhanced, Sink
Display Units	x.x %
Drive Units	4096 @ rated motor torque
Factory Default	0.0%
Minimum Value	-800%
Maximum Value	+800%

Internal Torque Reference
[Int Torq Ref]

This parameter shows the value of torque reference that is present at the output of the torque limiter.

Parameter Number	167
Parameter Type	Enhanced
Display Units	+/- x.x %
Drive Units	4096 = rated torque
Factory Default	+0.0 %
Minimum Value	-800%
Maximum Value	+800%

GROUP NO. 11
TORQUE
REFERENCE

Internal Iq Reference [Internal Iq Ref] This parameter shows the value of the Iq reference that is present at the output of the Iq rate limiter. 4096 is 100% Iq motor current.	Parameter Number	168
	Parameter Type	Enhanced
	Display Units	+/- x.x%
	Drive Units	4096 = rated torque
	Factory Default	+0.0 %
	Minimum Value	- 8 00%
	Maximum Value	+ 8 00%

Torque Scale % (KAL) [Torque Scale %] This parameter specifies a "calibration gain" used to scale the Torque Reference immediately prior to conversion to an Iq reference. 4096 is unity gain within a range of 0 to 8192.	Parameter Number	171
	Parameter Type	Enhanced
	Display Units	x.xx %
	Drive Units	4096 = 100% = 1.0 gain
	Factory Default	100.0%
	Minimum Value	0.00%
	Maximum Value	200.0%

Torque Reference Testpoint Data [Torq Ref TP] This parameter indicates the value of the internal location selected by the Torque Reference Testpoint Select parameter. The select will allow this parameter to be used as a testpoint for the torque reference input.	Parameter Number	172
	Parameter Type	Enhanced
	Display Units	+/- x.x%
	Drive Units	4096 = 100% (1.0 pu)
	Factory Default	+ 0.0%
	Minimum Value	- 800%
	Maximum Value	+ 800%

Torque Reference Testpoint Select [Torque Ref TP Sel] This parameter selects which internal location of the torque reference will become the testpoint value. The value based on the select will be stored in the Torque Reference Testpoint Data parameter.	Parameter Number	173
	Parameter Type	Enhanced
	Display Units	x
	Drive Units	x
	Factory Default	0
	Minimum Value	0
	Maximum Value	31

Select Value	Torque Reference Access Point	Select Value	Torque Reference Access Point
0	Zero	18	Torque Reference Math Overflow Status
1	NTC Limit	19	Active Torque Mode
2	Inverter Current Limit	20	Positive Torque Power Limit
3	Absolute Current Limit	21	Negative Torque Power Limit
4	Positive Iq Limit	22	Rated Inverter Current
5	Negative Iq Limit	23	Averaged Motor Flux
6	Zero (Not Used)	24	Iq Current Reference Adjusted for Motor Range
7	Torque Limit (Low)	25	Iq Sum
8	Torque Limit (High)	26	Torque Mode Select Iq Ref
9	Scaled External Torque Reference 1	27	Inverted Gain
10	Scaled External Torque Reference 2	28	Motor Range
11	Torque Sum	29	Motor to Current Ratio
12	Torque Command	30	DC Bus Ride-Thru Latch
13	Filtered Torque Reference	31	Current Processor Regulation Active Flag
14	Unlimited Iq Reference		
15	Current Limited Iq Reference		
16	Filtered Iq Reference		
17	Torque Reference Status		

Minimum Flux Level [Miin Flux Level] This parameter sets the smallest level of flux that will be used to convert a torque to a current reference. Setting the parameter to 4096 will prevent flux reduction and bypass the torque to current conversion.	Parameter Number	174
	Parameter Type	Enhanced
	Display Units	x.x%
	Drive Units	4096 = 100% Flux
	Factory Default	100%
	Maximum Value	100%

GROUP NO. 11
TORQUE
REFERENCE

<p>Pos Torque Reference Limit [Pos Mtr Tor Lmt]</p> <p>This parameter provides a user settable torque limit for positive torque reference values. Positive motor torque reference will not be allowed to exceed this value.</p>	<p>Parameter Number 175 Parameter Type Enhanced, Sink Display Units x.x% Drive Units 4096 @ rated motor torque Factory Default 200.0% Minimum Value 0.0% Maximum Value 800.0%</p>
<p>Neg Torque Reference Limit [Neg Mtr Tor Lim]</p> <p>This parameter provides a user settable torque limit for negative torque reference values. Negative motor torque reference will not be allowed to exceed this value.</p>	<p>Parameter Number 176 Parameter Type Enhanced, Sink Display Units -x.x% Drive Units -4096 @ rated motor torque Factory Default -200% Minimum Value -800% Maximum Value 0.0%</p>
<p>Motoring Power Limit [Motor Power Lmt]</p> <p>This parameter provides for a user entry of the maximum power level that will be supplied to the motor from the DC bus. The motoring power limit is used in a calculation that results in an internal torque limit.</p>	<p>Parameter Number 177 Parameter Type Enhanced, Sink Display Units x.x% Drive Units 4096 @ rated motoring power Factory Default 200% Minimum Value 0.0% Maximum Value 800%</p>
<p>Regen Power Limit [Regen Power Lim]</p> <p>This parameter provides a user entry for the maximum power level that will be transferred from the motor to the DC bus.</p>	<p>Parameter Number 178 Parameter Type Enhanced, Sink Display Units -x.x% Drive Units 4096 @ rated regen power Factory Default -200% Minimum Value -800% Maximum Value 0.0%</p>
<p>Positive Motor Current Reference Limit [Pos Mtr Cur Lim]</p> <p>This parameter specifies the largest allowable positive motor Iq axis current that will be commanded. Bit 0 in Parm 183 indicates when this parameter is actively restricting Iq current.</p>	<p>Parameter Number 179 Parameter Type Basic, Sink Display Units x.x % Drive Units 4096 @ 100% Motor Current (I₂) Factory Default 100 % Minimum Value 0.0 % Maximum Value 200 %</p>
<p>Negative Motor Current Reference Limit [Neg Mtr Cur Lim]</p> <p>This parameter determines the largest allowable negative motor Iq axis current that will be commanded. Bit 0 in Parm 183 indicates when this parameter is actively restricting Iq current.</p>	<p>Parameter Number 180 Parameter Type Basic, Sink Display Units -x.x % Drive Units 4096 @ 100% Motor Current (I₂) Factory Default -100% Minimum Value -200% Maximum Value +0.0%</p>
<p>Di/DT Limit [Di/Dt Limit]</p> <p>This parameter determines the largest allowable rate of change for the Iq reference signal. This number is scaled in units of maximum per unit Iq every 2 msec.</p>	<p>Parameter Number 181 Parameter Type Enhanced Display Units x.x% Drive Units 4096 = 100% Iq per 2msec Factory Default 40% Minimum Value 0.0% Maximum Value 60%</p>

GROUP NO. 11
TORQUE
REFERENCE

<p>Computed Power [Computed Power]</p> <p>Calculated product of Torque Reference times motor velocity feedback. A 125 msec filter is applied to this result. Positive values indicate motoring power, negative regenerative power.</p>	<p>Parameter Number 182 Parameter Type Basic, Source Display Units +/- x.x% Drive Units 4096 @ 100% Power Factory Default +0.0% Minimum Value -800.0% Maximum Value +800.0%</p>
<p>Torque Limit Status [Torq Lmt Status]</p> <p>This parameter provides a bit coded summary of any condition that may be limiting either the IQ current or torque reference.</p> <p>0 = Positive Motor IQ 1 = NTC Inverter Protection Foldback 2 = IT Inverter Protection Foldback 3 = Maximum Inverter Current 4 = Positive Torque Limit 5 = Positive Torque Power Limit 6 = Autotune Torque Limit 7 = Not Used 8 = Negative Motor Iq</p>	<p>Parameter Number 183 Parameter Type Basic Display Units Bits Drive Units Bits Factory Default 0000 hex Minimum Value 0000 hex Maximum Value FFFF hex</p> <p>9 = NTC Inverter Protection Foldback 10 = IT Inverter Protection Foldback 11 = Maximum Inverter Current 12 = Negative Torque Limit 13 = Negative Torque Power Limit 14 = Autotune Torque Limit 15 = Not Used</p>

GROUP NO. 12
INVERTER
CONFIGURATION

<p>Rated Inverter Output Amps [Base Drive Cur]</p> <p>Current rating of inverter. Automatically set by drive at powerup as a function of Power Structure Type. Used for current ref scaling and current processor feedback scaling.</p>	<p>Parameter Number 220 Parameter Type Basic, Sink Display Units x.x amps Drive Units Display units x 10 Factory Default 20.0 amps Minimum Value 0.1 amps Maximum Value 3,276.7 amps</p>
<p>Rated Inverter Input Voltage [BaseLine Volts]</p> <p>Drive Nameplate Voltage rating of inverter. Automatically set by drive at powerup as a function of Power Structure Type.</p>	<p>Parameter Number 221 Parameter Type Basic, Sink Display Units xx.x Vlt Drive Units x Factory Default 460 volts Minimum Value 75 volts Maximum Value 575 volts</p>
<p>Inverter Carrier Frequency [PWM Frequency]</p> <p>This parameter defines the drive carrier frequency in Hz.</p>	<p>Parameter Number 222 Parameter Type Basic, Sink Display Units x Hz Drive Units x Factory Default 4,000 Hz Minimum Value 1,000 Hz Maximum Value 12,000 Hz</p>

GROUP 12
INVERTER
CONFIGURATION

<p>Precharge/Ridethru Selection [Prech/Rdthru Sel]</p> <p>Configuration bits for the DC bus precharge and low bus ridethrough functions. This parameter is bit encoded as follows: Bit 12 – Enables precharge as a common bus inverter when set Bit 13 – Disables Bus precharge timeout and undervoltage while the Drive is DISABLED when set Bit 14 – Disables all subsequent precharges after first powerup when set Bit 15 – Disables all ridethroughs when set</p>	<p>Parameter Number 223 Parameter Type Enhanced, Sink Display Units Bits Drive Units Bits Factory Default 0000 hex Minimum Value 0000 hex Maximum Value FFFF hex</p>
<p>Undervoltage Setpoint [Under Volt Stpntf]</p> <p>This sets the minimum threshold voltage that will be compared with the DC Bus Voltage as a check for a Bus Undervoltage condition.</p>	<p>Parameter Number 224 Parameter Type Enhanced, Sink Display Units x Volts Drive Units Factory Default 400 volts Minimum Value 30 volts Maximum Value 65,535 volts</p>
<p>Bus Precharge Timeout [Prechg Timeout]</p> <p>This parameter establishes a time delay period for DC Bus Precharge. If the Drive fails to finish a DC Bus Precharge in this time, a Precharge Timeout will occur.</p>	<p>Parameter Number 225 Parameter Type Enhanced, Sink Display Units x.x Sec. Drive Units Display units times 10 Factory Default 30.0 Sec. Minimum Value 0.0 Sec. Maximum Value 6553.5 Sec.</p>
<p>Bus Ridethru Timeout [Ridethru Timeout]</p> <p>This parameter establishes a time delay period for DC Bus Ridethrough. If the bus remains in a low bus ridethrough condition longer than this time, a Bus ridethru condition will occur.</p>	<p>Parameter Number 226 Parameter Type Enhanced, Sink Display Units x.xxx Sec. Drive Units Display units times 1000 Factory Default 2.000 Sec. Minimum Value 0.000 Sec. Maximum Value 65.535 Sec.</p>
<p>CP Operating Options [CP Options]</p> <p>This bit coded parameter is used to enable/disable options in the operation of the Current Processor (1 = Option Enabled, 0 = Option disabled). The following options are available: 0 = RTD Adapter ON 1 = RTD Filter ON</p>	<p>Parameter Number 227 Parameter Type Enhanced Display Units Bits Drive Units Bits Factory Default 0000 hex Minimum Value 0000 hex Maximum Value 003F hex</p>

**GROUP 13
MOTOR
NAMEPLATE DATA**

<p>Motor Nameplate Horsepower [Motor HP]</p> <p>User entered value of nameplate motor horsepower. The drive uses this information in the Dynamic Brake Resistor temperature calculation.</p>	<p>Parameter Number 228 Parameter Type Enhanced, Sink Display Units x.x HP Drive Units Display units x 10 Factory Default 30.0 HP Minimum Value 1.0 HP Maximum Value 2000.0 HP</p>
<p>Base Motor Speed [Base Motor Speed]</p> <p>User entered value of nameplate motor speed in RPM. The drive uses this information to convert motor velocity RPM to/from drive per unit.</p>	<p>Parameter Number 229 Parameter Type Basic, Sink Display Units x RPM Drive Units x Factory Default 1,750 RPM Minimum Value 1 RPM Maximum Value 6,000 RPM</p>
<p>Motor Nameplate AMPS [Base Motor Curr]</p> <p>Drive nameplate current rating of the motor. Used for current reference scaling and current processor feedback scaling.</p>	<p>Parameter Number 230 Parameter Type Basic, Sink Display Units x.x Amps Drive Units Display units x 10 Factory Default 0.2 amps Minimum Value 0.1 amps Maximum Value 3,276.7 amps</p>
<p>Motor Nameplate VOLTS [Base Motor Volt]</p> <p>Drive nameplate voltage rating of the motor.</p>	<p>Parameter Number 231 Parameter Type Basic, Sink Display Units x Vlt Drive Units x Factory Default 240 volts Minimum Value 75 volts Maximum Value 575 volts</p>
<p>Motor Nameplate FREquency [Base Motor Freq.]</p> <p>Drive nameplate frequency rating of the motor.</p>	<p>Parameter Number 232 Parameter Type Basic, Sink Display Units xxx Hz Drive Units x Factory Default 60 Hz Minimum Value 1 Hz Maximum Value 250 Hz</p>
<p>Motor Nameplate Poles [Motor Poles]</p>	<p>Parameter Number 233 Parameter Type Basic, Sink Display Units x Drive Units x Factory Default 4 poles Minimum Value 2 poles Maximum Value 10 poles</p>
<p>Motor Inertia [Motor Inertia]</p> <p>User selectable time taken to accelerate an uncoupled motor from zero to base speed at rated torque.</p>	<p>Parameter Number 234 Parameter Type Enhanced, Sink Display Units x.xx Sec. Drive Units Display units times 100 Factory Default 0.60 Sec Minimum Value 0.01 Sec. Maximum Value 10.00 Sec.</p>

Chapter 5
Programming Parameters

GROUP 13
MOTOR
NAMEPLATE DATA

Encoder PPR
[Encoder PPR]

User entered pulse per revolution rating of the feedback device when using an encoder to determine motor velocity.

Parameter Number	235
Parameter Type	Basic, Sink
Display Units	x
Drive Units	x
Factory Default	1,024 ppr
Minimum Value	500 ppr
Maximum Value	20,000 ppr

GROUP 14
MOTOR
CONSTANTS

RS Tune
[Stator Resistance]

Sum of the stator and cable resistances of the motor in a per unit (percent representation) This parameter can be entered manually or be determined by the autocommissioning routine.

Parameter Number	236
Parameter Type	Enhanced
Display Units	x.xx %
Drive Units	4096 = 100% Stator Res
Factory Default	1.50%
Minimum Value	0.00%
Maximum Value	100.00%

Lsigma Tune [Leakage Inductance]
[Leakage Ind]

Sum of the motor stator and rotor leakage inductances and the motor cable inductance in a per unit base impedance. This parameter can be entered manually or be determined by the autocommissioning routine.

Parameter Number	237
Parameter Type	Enhanced
Display Units	X.xx%
Drive Units	4096 = 100% Leakage Ind.
Factory Default	18%
Minimum Value	0.0%
Maximum Value	100.00%

Id Tune [Base Flux Current]
[Base Flux Cur]

Magnetizing current which produces rated flux in the motor in a per unit (percent) representation.

Parameter Number	238
Parameter Type	Enhanced
Display Units	x.x%
Drive Units	4096 = 100% motor amps
Factory Default	30.0%
Minimum Value	0.0%
Maximum Value	75.0%

**GROUP 15
TORQUE
REGULATOR**

<p>Iq Tune (Rated Torque Current) [Base Torque Cur] Current which produces rated torque in the motor in a per unit (percent) representation.</p>	<p>Parameter Number 240 Parameter Type Enhanced Display Units x.x% Drive Units 1024 = 100% Iq Motor Factory Default 95.40 % Minimum Value 0.00% Maximum Value 100.00%</p>
<p>Vde Tune (Base Torque Voltage) [Base Torque Volt] D axis voltage command to the motor at rated speed and rated current. Parameter calculated by autocommissioning routine. Data represented as X.X volts</p>	<p>Parameter Number 241 Parameter Type Enhanced Display Units x.x volts Drive Units 16 = 1 volt (L-N) Factory Default -75.0 volts Minimum Value -468.0 volts Maximum Value 0.0 volts</p>
<p>Vqe Tune (Rated Flux Voltage) [Base Flux Volt] Q axis voltage command to the motor at rated speed and rated current if motor is not in field weakening. Parameter calculated by autocommissioning routine. Data represented as X.X volts</p>	<p>Parameter Number 242 Parameter Type Enhanced Display Units x.x volts Drive Units 16 = 1 volt (L-N) Factory Default 367.0 volts Minimum Value 0.0 volts Maximum Value 468.0 volts</p>
<p>Vde Maximum (Peak HP) [Vde Max] Maximum D axis voltage allowed on the motor. Parameter calculated by autocommissioning routine and MUST NOT BE CHANGED. Data represented as X.X volts</p>	<p>Parameter Number 243 Parameter Type Basic Display Units x.x volts Drive Units 16 = 1 volt line to neutral peak Factory Default 356 volts Minimum Value 0.0 volts Maximum Value 375 volts</p>
<p>Vqe Maximum (Constant HP) [Vqe Max] Q axis voltage at which the motor enters field weakening. Parameter calculated by autocommissioning routine and MUST NOT BE CHANGED. Data represented as X.X volts</p>	<p>Parameter Number 244 Parameter Type Enhanced Display Units x.x volts Drive Units 16 = 1 volt (L-N) Factory Default 367.0 volts Minimum Value 0,0 volts Maximum Value 468.8 volts</p>
<p>Vde Minimum (Constant HP) [Vde Min] D axis voltage below which the adaption to motor changes in the torque control is disabled. Parameter calculated by autocommissioning routine and MUST NOT BE CHANGED. Data represented as X.X volts</p>	<p>Parameter Number 245 Parameter Type Enhanced Display Units x.x Volts Drive Units 16 = 1 volt line to neutral peak Factory Default 3.0 volts Minimum Value 0.0 volts Maximum Value 50.0 volts</p>
<p>Kslip (Base Slip Frequency) [Base Slip Freq] Base slip frequency of the motor. Parameter calculated by autocommissioning routine and MUST NOT BE CHANGED. Data represented as X.X Hz.</p>	<p>Parameter Number 246 Parameter Type Enhanced Display Units x.xxx Hz Drive Units 256 = 1Hz/unit torque Factory Default 0.469 Hz Minimum Value 0.000 Hz Maximum Value 10.0 Hz</p>

**GROUP 15
TORQUE
REGULATOR**

<p>Kslip Maximum [Base Slip Max]</p> <p>Maximum slip frequency allowed on the motor. Calculated by autocommissioning routine and MUST NOT BE CHANGED. Data represented as X.X Hz.</p>	<p>Parameter Number 247 Parameter Type Enhanced Display Units x.xx Hz Drive Units 256 = 1Hz/unit torque Factory Default 2.00 Hz Minimum Value 0.00 Hz Maximum Value 30.00 Hz</p>
<p>Kslip Minimum [Slip Min]</p> <p>Minimum slip frequency allowed on the motor. Calculated by autocommissioning routine and MUST NOT BE CHANGED. Data represented as X.X Hz.</p>	<p>Parameter Number 248 Parameter Type Enhanced Display Units x.xx Hz Drive Units 256 = 1Hz / unit torque Factory Default 0.50 Hz Minimum Value 0.00 Hz Maximum Value 10.00 Hz</p>
<p>Kp – Slip Regulator [Kp Slip]</p> <p>Proportional Gain of the slip regulator. This parameter MUST NOT BE CHANGED. Data represented as X.</p>	<p>Parameter Number 249 Parameter Type Enhanced Display Units x Drive Units x Factory Default 153 Minimum Value 0 Maximum Value 32767</p>
<p>KI – Slip Regulator [Ki Slip]</p> <p>Integral Gain of the slip regulator. This parameter MUST NOT BE CHANGED. Data represented as X.</p>	<p>Parameter Number 250 Parameter Type Basic Display Units x Drive Units x Factory Default 306 Minimum Value 0 Maximum Value 32767</p>
<p>Kp – Flux Regulator [Kp Flux]</p> <p>Proportional Gain of the Flux regulator. This parameter MUST NOT BE CHANGED. Data represented as X.</p>	<p>Parameter Number 251 Parameter Type Enhanced Display Units x Drive Units x Factory Default 300 Minimum Value 0 Maximum Value 32767</p>
<p>Ki – Regulator [Ki Flux]</p> <p>Integral gain of the slip regulator. This parameter MUST NOT BE CHANGED. Data represented as X.</p>	<p>Parameter Number 252 Parameter Type Enhanced Display Units x Drive Units x Factory Default 125 Minimum Value 0 Maximum Value 32767</p>

**GROUP 16
AUTOTUNE
DIAGNOSTICS**

Autotune/Diagnostics Selection
[Autotune Diag Sel]

This parameter allows selection of drive diagnostic and commissioning tests by setting individual bits in this parameter:

- Bit 0 = Inverter transistor Diagnostics
- Bit 1 = Motor Phase Rotation Test
- Bit 2 = Leakage inductance Test
- Bit 3 = Stator Resistance Tests
- Bit 4 = Id Measure
- Bit 5 = Update Torque Block Gains
- Bit 6 = Motor Inertia Test
- Bit 7 = System Inertia Test
- Bit 8 = Update Velocity Regulator Gains

Parameter Number	256
Parameter Type	Basic, Sink
Display Units	Bits
Drive Units	Bits
Factory Default	0000 hex
Minimum Value	0000 hex
Maximum Value	01FF hex

Transistor Diagnostics Configuration
[Tran Diag Cfg]

This parameter provides a means of disabling certain transistor diagnostic tests by setting the following bits:

- Bit 0 = Current Feedback phase U offset tests
- Bit 1 = Current Feedback phase W offset tests
- Bit 2 = Shorted power transistor tests
- Bit 3 = Ground fault tests
- Bit 4 = Open transistor, open motor, open current feedback, open gate drive and open bus fuse tests
- Bit 5 = Reserved (Always leave 0)
- Bit 6 = Power Trans U upper for all tests
- Bit 7 = Power Trans U lower for all tests
- Bit 8 = Power Trans V upper for all tests
- Bit 9 = Power Trans V lower for all tests

Parameter Number	257
Parameter Type	Basic, Sink
Display Units	Bits
Drive Units	Bits
Factory Default	0000 hex
Minimum Value	0000 hex
Maximum Value	FFFF hex

- Bit 10 = Power Trans W upper for all tests
- Bit 11 = Power Trans W lower for all tests
- Bit 12 = Reserved (Always leave 0)
- Bit 13 = Reserved (Always leave 0)
- Bit 14 = Reserved (Always leave 0)
- Bit 15 = Reserved (Always leave 0)

Inverter Diagnostics Result #1
[Inverter Diag #1]

The results of the Transistor Diagnostic Tests are given in parameter 258, 259 and Torque Block testpoints 28 through 30.

Parameter Number	258
Parameter Type	Enhanced
Display Units	Bits
Drive Units	Bits
Factory Default	0000 hex
Minimum Value	0000 hex
Maximum Value	FFFF hex

- Bit 0 = Software Fault
- Bit 1 = No motor connected, or open bus fuse
- Bit 2 = Phase U and W Shorted
- Bit 3 = Phase U and V shorted
- Bit 4 = Phase V and W shorted
- Bit 5 = Shorted modules
- Bit 6 = Ground fault
- Bit 7 = Fault before shorted module ran
- Bit 8 = Hardware overvoltage fault occurred
- Bit 9 = Hardware desaturation fault occurred
- Bit 10 = Hardware ground fault occurred
- Bit 11 = Hardware phase overcurrent fault occurred
- Bit 12 = Open power transistor(s)
- Bit 13 = Current feedback faults(s)
- Bit 14 = Low bus voltage
- Bit 15 = Not Used

Chapter 5 Programming Parameters

GROUP 16 AUTOTUNE DIAGNOSTICS

Inverter Diagnostics Result #2

[Inverter Diag 2]

The results of the Transistor Diagnostic Tests are given in parameter 258, 259 and Torque Block testpoints 28 through 30. If any of the bits shown below are set, then a problem with the associated test is indicated.

0 = Transistor U upper shorted
1 = Transistor U lower shorted
2 = Transistor V upper shorted
3 = Transistor V lower shorted
4 = Transistor W upper shorted
5 = Transistor W lower shorted

Parameter Number	259
Parameter Type	Basic
Display Units	Bits
Drive Units	Bits
Factory Default	0000 hex
Minimum Value	0000 hex
Maximum Value	FFFF hex

6 = Current fdbk ph U offset too big
7 = Current fdbk ph W offset too big
8 = Transistor U upper open
9 = Transistor U lower open
10 = Transistor V upper open

11 = Transistor V lower open
12 = Transistor W upper open
13 = Transistor W lower open
14 = Current feedback phase U open
15 = Current feedback phase W open

Iq OFFSET

[Iq Offset]

This parameter contains the LEM U offset required to null the current error. (no motor current flowing) This offset is set automatically by running the transistor diagnostics.

Parameter Number	260
Parameter Type	Enhanced
Display Units	+/- x
Drive Units	+/- x
Factory Default	+0
Minimum Value	-100
Maximum Value	+100

Id OFFSET

[Id Offset]

This parameter contains the LEM W offset required to null the current error. (no motor current flowing) This offset is set automatically by running the transistor diagnostics.

Parameter Number	261
Parameter Type	Enhanced
Display Units	+/-
Drive Units	+/- X
Factory Default	+0
Minimum Value	-100
Maximum Value	+100

Phase Rotation Current Reference

[Ph Rot Cur Ref]

This parameter sets the current reference that will be used when the Phase Rotation test is run (Parm 256, bit 1)

Parameter Number	262
Parameter Type	Enhanced, Sink
Display Units	x.x%
Drive Units	4096 = 100% Motor Current
Factory Default	50%
Minimum Value	0.0%
Maximum Value	100%

Phase Rotation Frequency Reference

[Ph Rot Freq Ref]

This parameter sets the frequency reference that will be used when the Phase Rotation test is run (Parm 256, bit 1)

Parameter Number	263
Parameter Type	Enhanced, Sink
Display Units	x.x Hz
Drive Units	128 @ 1 Hz
Factory Default	3.0 Hz
Minimum Value	-30.0 Hz
Maximum Value	+30.0 Hz

GROUP NO. 17 METERING

Motor Current Magnitude Feedback

[Motor Cur Fdbk]

Displays the actual RMS value of the motor current as determined from the LEM current sensors. This data is averaged and updated on a 50 millisecond basis.

Parameter Number	264
Parameter Type	Basic
Display Units	x.x Amp
Drive Units	Display units x 10
Factory Default	+ 0.0 amps
Minimum Value	0.0 amps
Maximum Value	6,553.5 amps

**GROUP NO. 17
METERING**

<p>Motor Voltage Magnitude [Motor Volt Fdbk]</p> <p>Displays the actual Line-to-Line RMS value of motor voltage. This data is averaged and updated on a 50 millisecond basis.</p>	<table border="0"> <tr><td>Parameter Number</td><td>265</td></tr> <tr><td>Parameter Type</td><td>Basic, Source</td></tr> <tr><td>Display Units</td><td>x Vlt</td></tr> <tr><td>Drive Units</td><td>x</td></tr> <tr><td>Factory Default</td><td>+ 0 volts</td></tr> <tr><td>Minimum Value</td><td>- 3,000 volts</td></tr> <tr><td>Maximum Value</td><td>+3,000 Volts</td></tr> </table>	Parameter Number	265	Parameter Type	Basic, Source	Display Units	x Vlt	Drive Units	x	Factory Default	+ 0 volts	Minimum Value	- 3,000 volts	Maximum Value	+3,000 Volts
Parameter Number	265														
Parameter Type	Basic, Source														
Display Units	x Vlt														
Drive Units	x														
Factory Default	+ 0 volts														
Minimum Value	- 3,000 volts														
Maximum Value	+3,000 Volts														
<p>Stator Frequency [Freq Command]</p> <p>Displays the actual value of motor stator frequency. Units are in Hz times 128 (128 @ 1 Hz)</p>	<table border="0"> <tr><td>Parameter Number</td><td>266</td></tr> <tr><td>Parameter Type</td><td>Basic, Source</td></tr> <tr><td>Display Units</td><td>x .xxx Hz</td></tr> <tr><td>Drive Units</td><td>128 @ 1Hz</td></tr> <tr><td>Factory Default</td><td>0 .000 Hz</td></tr> <tr><td>Minimum Value</td><td>-255.992 Hz</td></tr> <tr><td>Maximum Value</td><td>+255.922 Hz</td></tr> </table>	Parameter Number	266	Parameter Type	Basic, Source	Display Units	x .xxx Hz	Drive Units	128 @ 1Hz	Factory Default	0 .000 Hz	Minimum Value	-255.992 Hz	Maximum Value	+255.922 Hz
Parameter Number	266														
Parameter Type	Basic, Source														
Display Units	x .xxx Hz														
Drive Units	128 @ 1Hz														
Factory Default	0 .000 Hz														
Minimum Value	-255.992 Hz														
Maximum Value	+255.922 Hz														
<p>Torque Feedback [Torque Fdbk]</p> <p>Displays the actual value of motor torque feedback as determined by the Current Processor. Scaling is 4096 at rated motor torque.</p>	<table border="0"> <tr><td>Parameter Number</td><td>267</td></tr> <tr><td>Parameter Type</td><td>Basic, Source</td></tr> <tr><td>Display Units</td><td>+/- x.x%</td></tr> <tr><td>Drive Units</td><td>4096 @ Rated Motor Torque</td></tr> <tr><td>Factory Default</td><td>+ 0.0 %</td></tr> <tr><td>Minimum Value</td><td>- 800.0 %</td></tr> <tr><td>Maximum Value</td><td>+ 800.0 %</td></tr> </table>	Parameter Number	267	Parameter Type	Basic, Source	Display Units	+/- x.x%	Drive Units	4096 @ Rated Motor Torque	Factory Default	+ 0.0 %	Minimum Value	- 800.0 %	Maximum Value	+ 800.0 %
Parameter Number	267														
Parameter Type	Basic, Source														
Display Units	+/- x.x%														
Drive Units	4096 @ Rated Motor Torque														
Factory Default	+ 0.0 %														
Minimum Value	- 800.0 %														
Maximum Value	+ 800.0 %														
<p>DC Bus Voltage [DC Bus Voltage]</p> <p>This is the actual Bus Voltage as read by the software from an analog input port. Units are in volts.</p>	<table border="0"> <tr><td>Parameter Number</td><td>268</td></tr> <tr><td>Parameter Type</td><td>Basic, Source</td></tr> <tr><td>Display Units</td><td>x Vlt</td></tr> <tr><td>Drive Units</td><td>x</td></tr> <tr><td>Factory Default</td><td>0 volts</td></tr> <tr><td>Minimum Value</td><td>0 volts</td></tr> <tr><td>Maximum Value</td><td>65,535 volts</td></tr> </table>	Parameter Number	268	Parameter Type	Basic, Source	Display Units	x Vlt	Drive Units	x	Factory Default	0 volts	Minimum Value	0 volts	Maximum Value	65,535 volts
Parameter Number	268														
Parameter Type	Basic, Source														
Display Units	x Vlt														
Drive Units	x														
Factory Default	0 volts														
Minimum Value	0 volts														
Maximum Value	65,535 volts														
<p>Motor Temperature Feedback [Motor Temp]</p> <p>Actual motor temperature determined by RTD in motor. Units are in degrees celcius.</p>	<table border="0"> <tr><td>Parameter Number</td><td>269</td></tr> <tr><td>Parameter Type</td><td>Basic, Source</td></tr> <tr><td>Display Units</td><td>x deg</td></tr> <tr><td>Drive Units</td><td>x</td></tr> <tr><td>Factory Default</td><td>0 deg C</td></tr> <tr><td>Minimum Value</td><td>- 153 deg C</td></tr> <tr><td>Maximum Value</td><td>+360 deg C</td></tr> </table>	Parameter Number	269	Parameter Type	Basic, Source	Display Units	x deg	Drive Units	x	Factory Default	0 deg C	Minimum Value	- 153 deg C	Maximum Value	+360 deg C
Parameter Number	269														
Parameter Type	Basic, Source														
Display Units	x deg														
Drive Units	x														
Factory Default	0 deg C														
Minimum Value	- 153 deg C														
Maximum Value	+360 deg C														
<p>Inverter Temperature Feedback [Inv Temp Fdbk]</p> <p>Inverter temperature determined by NTC device on heatsink power structure. Can be configured to generate either a warning or fault when heatsink reaches 80 degrees C.</p>	<table border="0"> <tr><td>Parameter Number</td><td>270</td></tr> <tr><td>Parameter Type</td><td>Basic, Source</td></tr> <tr><td>Display Units</td><td>x deg</td></tr> <tr><td>Drive Units</td><td>x</td></tr> <tr><td>Factory Default</td><td>0 deg C</td></tr> <tr><td>Minimum Value</td><td>- 50 deg C</td></tr> <tr><td>Maximum Value</td><td>+255 deg C</td></tr> </table>	Parameter Number	270	Parameter Type	Basic, Source	Display Units	x deg	Drive Units	x	Factory Default	0 deg C	Minimum Value	- 50 deg C	Maximum Value	+255 deg C
Parameter Number	270														
Parameter Type	Basic, Source														
Display Units	x deg														
Drive Units	x														
Factory Default	0 deg C														
Minimum Value	- 50 deg C														
Maximum Value	+255 deg C														
<p>Limited Motor Flux</p> <p>This parameter displays the level of motor field flux calculated by the current processor and limited by the Minimum Flux parameter (Par. 174).</p>	<table border="0"> <tr><td>Parameter Number</td><td>271</td></tr> <tr><td>Parameter Type</td><td>Basic</td></tr> <tr><td>Display Units</td><td>x.x%</td></tr> <tr><td>Drive Units</td><td>4096 = 100% flux</td></tr> <tr><td>Factory Default</td><td>100%</td></tr> <tr><td>Minimum Value</td><td>12.5%</td></tr> <tr><td>Maximum Value</td><td>100%</td></tr> </table>	Parameter Number	271	Parameter Type	Basic	Display Units	x.x%	Drive Units	4096 = 100% flux	Factory Default	100%	Minimum Value	12.5%	Maximum Value	100%
Parameter Number	271														
Parameter Type	Basic														
Display Units	x.x%														
Drive Units	4096 = 100% flux														
Factory Default	100%														
Minimum Value	12.5%														
Maximum Value	100%														

GROUP 18
TORQUE BLOCK
TEST POINT SEL

Testpoint Selection #1 [Torq TP Sel 1] This parameter not defined at this time.	Parameter Number	273
	Parameter Type	Basic
	Display Units	x
	Drive Units	x
	Factory Default	0
	Minimum Value	0
	Maximum Value	100

Testpoint Data #1 [Torq TP Data 1] This parameter is used to select torque block variables.	Parameter Number	274
	Parameter Type	Basic
	Display Units	+/- x
	Drive Units	+/- x
	Factory Default	0
	Minimum Value	-32767
	Maximum Value	32767

Testpoint Selection #2 [Torq TP Sel 2] This parameter is used to select torque block variables. The value of the variables appear in Parameter 276.	Parameter Number	275
	Parameter Type	Enhanced
	Display Units	x
	Drive Units	x
	Factory Default	0
	Minimum Value	0
	Maximum Value	100

Testpoint Data #2 [Torq TP Data 2] Value of the variable selected in 275.	Parameter Number	276
	Parameter Type	Enhanced
	Display Units	+/- x
	Drive Units	+/- x
	Factory Default	0
	Minimum Value	-32767
	Maximum Value	+32767

Testpoint Selection #3 [Torq TP Sel 3] This parameter is used to select torque block variables. The value of the variables appear in Parameter 278.	Parameter Number	277
	Parameter Type	Enhanced
	Display Units	x
	Drive Units	x
	Factory Default	0
	Minimum Value	0
	Maximum Value	100

Testpoint Data #3 [Torq TP Data 3] Value of the variable selected in 277.	Parameter Number	278
	Parameter Type	Enhanced
	Display Units	+/- x
	Drive Units	+/- x
	Factory Default	0
	Minimum Value	-32767
	Maximum Value	+32767

Testpoint Selection #4 [Torq TP Sel 4] This parameter is used to select torque block variables. The value of the variables appear in Parameter 280.	Parameter Number	279
	Parameter Type	Enhanced
	Display Units	x
	Drive Units	x
	Factory Default	0
	Minimum Value	0
	Maximum Value	100

GROUP 18
TORQUE BLOCK
TEST POINT SEL

Testpoint Data #4
[Torq TP Data 4]
Value of the variable selected in Parameter 279.

Parameter Number 280
Parameter Type Enhanced
Display Units +/- x
Drive Units +/-x
Factory Default 0
Minimum Value -32767
Maximum Value +32767

Testpoint Selection #5
[Torq TP Sel 5]
This parameter is used to select torque block variables. The values of the variables appear in Parameter 282.

Parameter Number 281
Parameter Type Enhanced
Display Units x
Drive Units x
Factory Default 0
Minimum Value 0
Maximum Value 100

Testpoint Data #5
[Torq TP Data 5]
Value of the variable selected in Parameter 281.

Parameter Number 282
Parameter Type Enhanced
Display Units +/- x
Drive Units +/- x
Factory Default 0
Minimum Value -32767
Maximum Value +32767

Testpoint Selection #6
[Torq TP Sel 6]
This parameter is used to select torque block variables. The values of the variables appear in Parameter 284.

Parameter Number 283
Parameter Type Enhanced
Display Units x
Drive Units x
Factory Default 0
Minimum Value 0
Maximum Value 100

Testpoint Data #6
[Torq TP Data 6]
Value of the variable selected in Parameter 283.

Parameter Number 284
Parameter Type Enhanced
Display Units +/- x
Drive Units +/-x
Factory Default 0
Minimum Value -32767
Maximum Value +32767

Selection for TEST DAC #1
[Test DAC 1 Sel]
This parameter is used to select torque block variables. The values of the variables appear at a test d/a on the main control board.

Parameter Number 285
Parameter Type Enhanced
Display Units x
Drive Units x
Factory Default 1
Minimum Value 0
Maximum Value 42

Selection for TEST DAC #2
[Test DAC 2 Sel]
This parameter is used to select torque block variables. The values of the variables appear at a test d/a on the main control board.

Parameter Number 286
Parameter Type Enhanced
Display Units x
Drive Units x
Factory Default 4
Minimum Value 0
Maximum Value 42

Chapter 5
Programming Parameters

GROUP 19
TEMPORARY
BLOCK

Dvbus dt
[DvBus dt]
Parameter Not Defined at this time.

Parameter Number	287
Parameter Type	Enhanced
Display Units	XV/ms
Drive Units	XV/ms
Factory Default	-10 v/ms
Minimum Value	-100 v/ms
Maximum Value	-1 v/ms

Bus Counts
[Bus Counts]
Parameter Not Defined at this time.

Parameter Number	288
Parameter Type	Enhanced
Display Units	x
Drive Units	x
Factory Default	10
Minimum Value	1
Maximum Value	128

PLC Comm Parameters

The parameters in the range from 300 to 500 are dedicated to the PLC Comm Adapter Board. PLC Communications Parameters are divided into 8 groups to help ease programming and operator access as follows:

GROUP 1 ADAPTER INFO		GROUP 2 ADAPTER DIAG		GROUP 3 SCANbus I/O		GROUP 4 MASKS	
300	PLC Comm Adpt ID	425	ChA RIO Fit Sel	314	Data In A1	408	Port Enable
301	PLC Comm Version	426	ChA RIO Warn Sel	315	Data In A2	409	Direction Mask
302	PLC Comm Config	430	ChB RIO Fit Sel	316	Data In B1	410	Start Mask
307	Func Blk Chksum	431	ChB RIO Warn Sel	317	Data In B2	411	Jog Mask
308	Func Blk ID	435	DIP Fault Setup	318	Data In C1	412	Reference Mask
309	Language Select	436	ChA Fault Sts	319	Data In C2	413	Clear Fault Mask
310	Adv/Basic Select	437	ChA Warn Sts	320	Data In D1	414	Reset Drive Mask
		438	ChB Fault Sts	321	Data In D2	415	Local Mask
		439	ChB Warn Sts	338	SB Analog In		
		440	SB Fault Sel	343	Data Out A1		
		441	SB Warn Sel	344	Data Out A2		
		442	SB Fault Sts	345	Data Out B1		
		443	SB Warn Sts	346	Data Out B2		
				347	Data Out C1		
				348	Data Out C2		
				349	Data Out D1		
				350	Data Out D2		
				367	Pt6 Logic Cmd In		
				368	Pt7 Logic Cmd In		
				386	SB Analog Out		
				391	SB Analog Sel		
				416	SB Default Ref		
GROUP 5 OWNERS		GROUP 6 ANALOG I/O		GROUP 7 ① CHANNEL A		GROUP 8 ① CHANNEL B	
369	Stop Owner	339	Analog In 1	303	ChA DIP Switch	304	ChB DIP Switch
370	Dir Owner	340	Analog In 2	305	ChA LED State	306	ChB LED State
371	Start Owner	341	Analog In 3				
372	Jog 1 Owner	342	Analog In 4	322	ChA RIO In 1	330	ChB RIO In 1
373	Jog 2 Owner	387	Analog Out 1	323	ChA RIO In 2	331	ChB RIO In 2
374	Set Ref Owner	388	Analog Out 2	324	ChA RIO In 3	332	ChB RIO In 3
375	Local Owner	389	Analog Out 3	325	ChA RIO In 4	333	ChB RIO In 4
376	Flux Owner	390	Analog Out 4	326	ChA RIO In 5	334	ChB RIO In 5
377	Trim Owner	392	Analog In 1 Offset	327	ChA RIO In 6	335	ChB RIO In 6
378	Ramp Owner	393	Analog In 1 Scale	328	ChA RIO In 7	336	ChB RIO In 7
379	Clrflt Owner	394	Analog In 2 Offset	329	ChA RIO In 8	337	ChB RIO In 8
		395	Analog In 2 Scale	351	ChA RIO Out 1	359	ChB RIO Out 1
		396	Analog In 3 Offset	352	ChA RIO Out 2	360	ChB RIO Out 2
		397	Analog In 3 Scale	353	ChA RIO Out 3	361	ChB RIO Out 3
		398	Analog In 4 Offset	354	ChA RIO Out 4	362	ChB RIO Out 4
		399	Analog In 4 Scale	355	ChA RIO Out 5	363	ChB RIO Out 5
		400	Analog Out 1 Offset	356	ChA RIO Out 6	364	ChB RIO Out 6
		401	Analog Out 1 Scale	357	ChA RIO Out 7	365	ChB RIO Out 7
		402	Analog Out 2 Offset	358	ChA RIO Out 8	366	ChB RIO Out 8
		403	Analog Out 2 Scale	427	Redund Chan No		
		404	Analog Out 3 Offset				
		405	Analog Out 3 Scale				
		406	Analog Out 4 Offset				
		407	Analog Out 4 Scale				

① Parameters included in GROUPS 7 and 8 will vary depending upon the selected communication protocol

For detailed parameter descriptions of PLC Comm Adapter parameters refer to the PLC Comm Adapter Reference Manual; 1336 FORCE – 5.7.

This Page Intentionally Blank

Derating Information

General

Customer Supplied Enclosure Requirements

1336 FORCE drives installed in customer supplied enclosures may be mounted within an enclosure or may be mounted to allow the heatsink to extend outside the enclosure. Use the information below in combination with the enclosure manufacturer's guidelines for sizing.

380-480V Drives ¹

Cat No.	Base Derate		Heat Dissipation ^{3, 4}		
	Amps ¹	Derate Curve ^{2, 3}	Drive Watts	Heatsink Watts	Total Watts
B007	14	None	91	270	361
B010	21	None	103	394	497
B015	27	Figure A	117	486	603
B020	34	Figure B	140	628	768
B025	42	Figure C	141	720	861
B030	48	Figure D	141	820	961
BX040	59	Figure E	175	933	1108
B040	65	Figure E	175	933	1108
B050	77	Figure F	193	1110	1303
BX060	77	Figure G	193	1110	1303
B060	96	⁵	361	1708	2069
B075	120	⁵	361	1708	2069
B100	150	⁵	426	1944	2370
B125	180	Figure H	522	2664	3186
BX150	180	⁵	606	2769	3375
B150	240	Figure I	606	2769	3375
B200	292	Figure J	755	3700	4455
B250	325	Figure K			

500-600V Drives

Cat No.	Base Derate		Heat Dissipation ^{3, 4}		
	Amps ¹	Derate Curve ^{2, 3}	Drive Watts	Heatsink Watts	Total Watts
C007-C060 ⁵		⁵	5	5	5

¹ Base Derate Amps are based on nominal voltage (480 or 600V). If input voltage exceeds Drive Rating, Drive Output must be derated. Refer to **Figure M**.

² Amp Rating is at 4 kHz. If carrier frequencies above 4 kHz are selected, drive Amp Rating must be derated. Refer to **Figures A-K**.

³ Drive Ambient Temperature Rating is 40°C. If ambient exceeds 40°C, the drive must be derated. Refer to **Figures A-K**.

⁴ Drive Rating is based on altitudes of 1,000 m (3,000 ft) or less. If installed at higher altitude, drive must be derated Refer to **Figure L**.

⁵ Not available at time of publication.

Derating Guidelines

Derating Factors

Drive ratings can be affected by a number of factors. If more than one factor exists, derating percentages must be multiplied. For example, if a 14 Amp drive is installed at a 2 km (6,600 ft.) altitude and has a 2% high input line voltage, the actual amp rating will be:

$$14 \times 94\% \text{ Altitude Derate} \times 96\% \text{ High Line Derate} = 12.6 \text{ Amps}$$

Figure A — Drive Rating B015
Carrier Frequency and Ambient
Temperature Derating

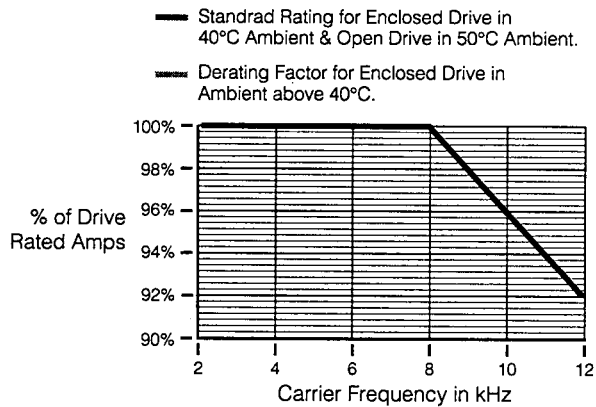

Figure B — Drive Rating B020
Carrier Frequency and Ambient
Temperature Derating

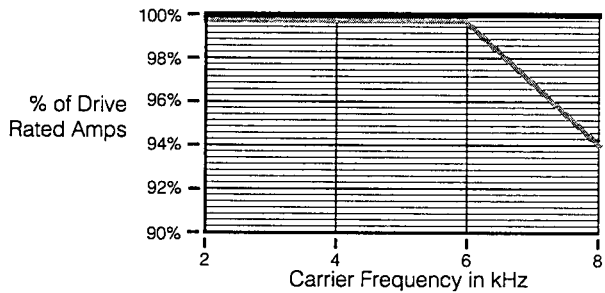

Figure C — Drive Rating B025
Carrier Frequency and Ambient
Temperature Derating

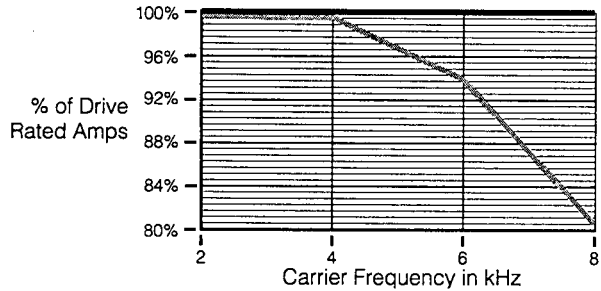

Figure D — Drive Rating B030
Carrier Frequency and Ambient
Temperature Derating

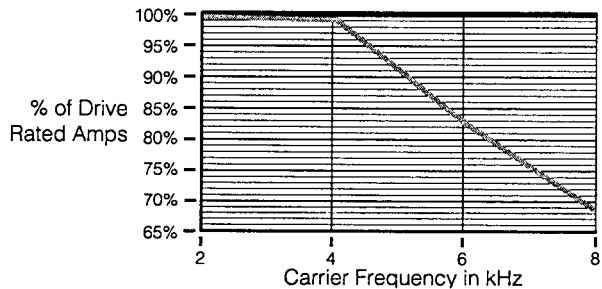

Figure E — Drive Rating B040/X040
Carrier Frequency and Ambient
Temperature Derating

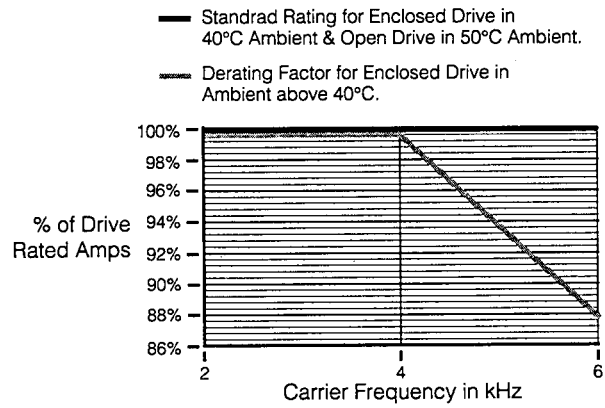

Figure F — Drive Rating B050
Carrier Frequency and Ambient
Temperature Derating

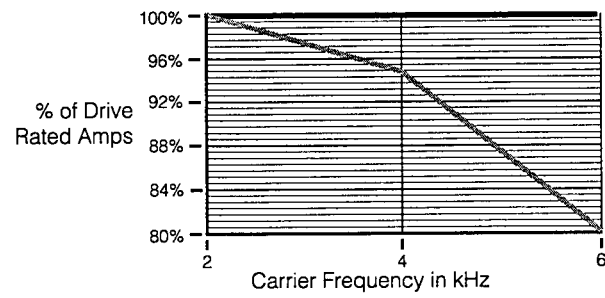

Figure G — Drive Rating BX060
Carrier Frequency and Ambient
Temperature Derating

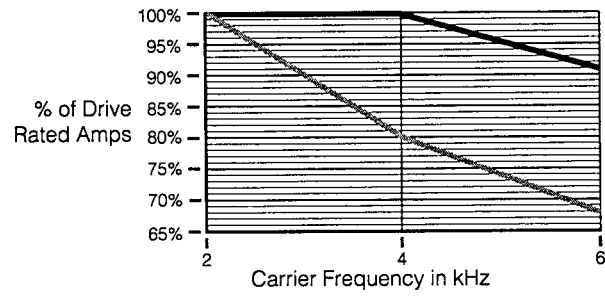
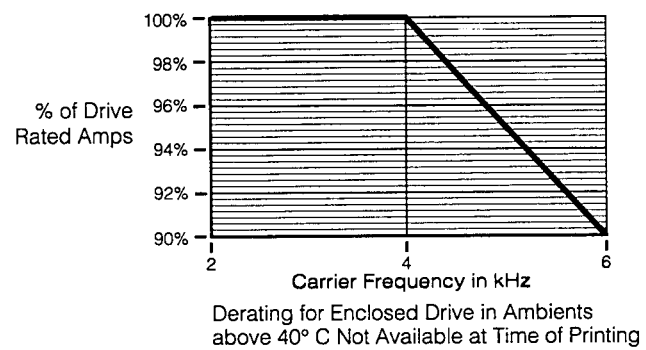
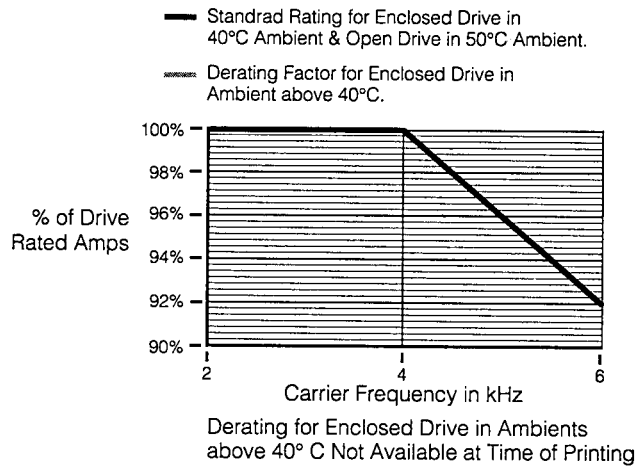

Figure H — Drive Rating B125
Carrier Frequency and Ambient
Temperature Derating



**Figure I — Drive Rating B150
Carrier Frequency and Ambient
Temperature Derating**



**Figure J — Drive Rating B200
Carrier Frequency and Ambient
Temperature Derating**

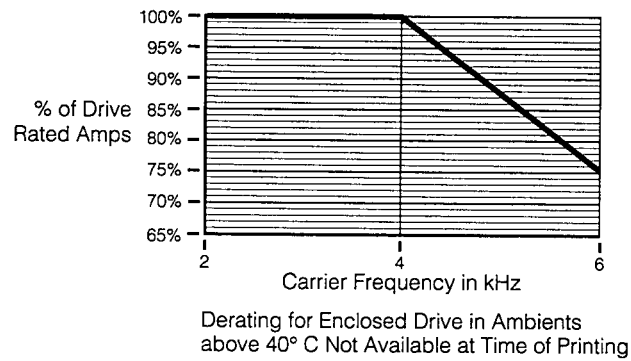

**Figure J — Drive Rating B200
Carrier Frequency and Ambient
Temperature Derating**

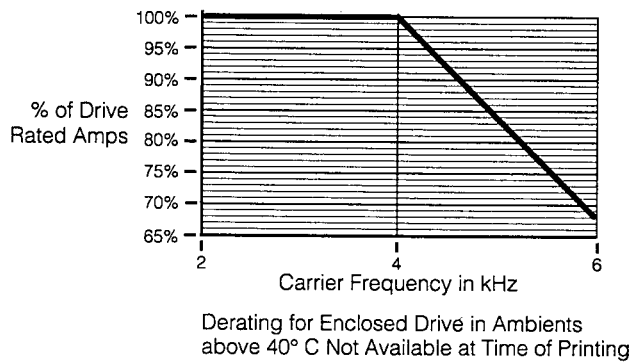

**Figure K — Drive Rating B250
Carrier Frequency and Ambient
Temperature Derating**

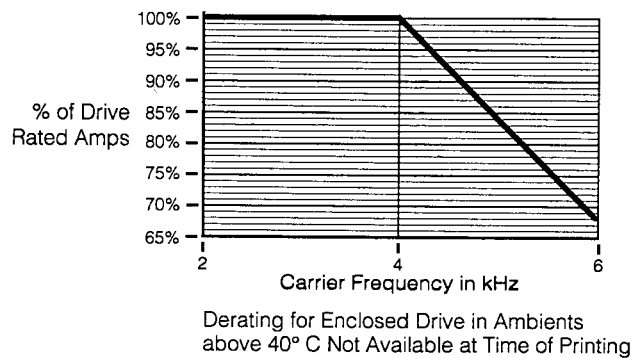

**Figure L — All Drive Ratings
Altitude Derating**

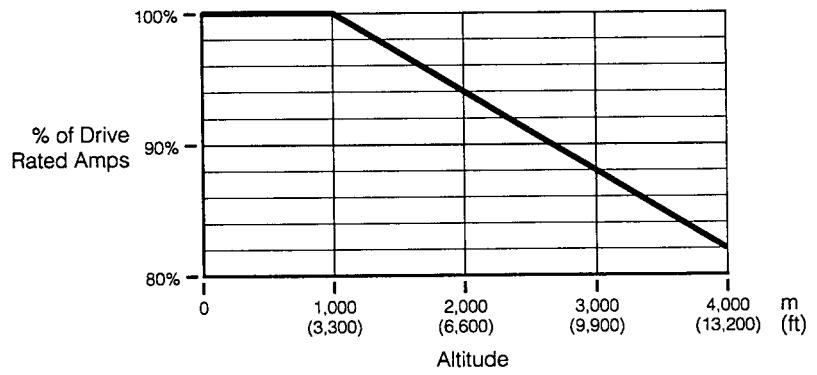

**Figure M — High Input Voltage
Derating**

**Required Only for the Following
Drives:**

18.5 kW (25 HP) at 8 kHz

22 kW (30 HP) at 6 or 8 kHz

45 kW (60 HP) at 6 kHz

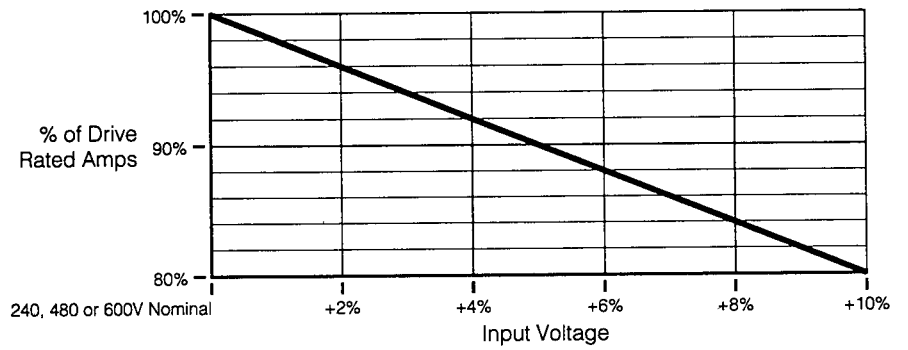

Appendix A

Derating Information

This Page Intentionally Blank

This Page Intentionally Blank

This Page Intentionally Blank

This Page Intentionally Blank

This Page Intentionally Blank

This Page Intentionally Blank

This Page Intentionally Blank



We Want Our Manuals to be the Best!

You can help! Our manuals must meet the needs of you, the user. This is your opportunity to make sure they do just that. By filling out this form you can help us provide the most useful, thorough, and accurate manuals available. Please take a few minutes to tell us what you think. Then mail or FAX this form.

FAX: to your local Allen-Bradley Sales Office or 414/512-8579

PUBLICATION NAME _____

PUBLICATION NUMBER, DATE AND PART NUMBER (IF PRESENT) _____

✓ CHECK THE FUNCTION THAT MOST CLEARLY DESCRIBES YOUR JOB.

- SUGGEST / RESPONSIBLE FOR THE PURCHASE OF EQUIPMENT
- DESIGN / IMPLEMENT ELECTRICAL SYSTEMS
- SUPERVISE FLOOR OPERATIONS
- MAINTAIN / OPERATE PROGRAMMABLE MACHINERY
- TRAIN / EDUCATE MACHINE USERS

✓ WHAT LEVEL OF EXPERIENCE DO YOU HAVE WITH EACH OF THE FOLLOWING PRODUCTS?

	NONE	LITTLE	MODERATE	EXTENSIVE
PROGRAMMABLE CONTROL	<input type="checkbox"/>	<input type="checkbox"/>	<input type="checkbox"/>	<input type="checkbox"/>
AC / DC DRIVES	<input type="checkbox"/>	<input type="checkbox"/>	<input type="checkbox"/>	<input type="checkbox"/>
PERSONAL COMPUTERS	<input type="checkbox"/>	<input type="checkbox"/>	<input type="checkbox"/>	<input type="checkbox"/>
NC / CNC CONTROLS	<input type="checkbox"/>	<input type="checkbox"/>	<input type="checkbox"/>	<input type="checkbox"/>
DATA COMMUNICATIONS / LAN	<input type="checkbox"/>	<input type="checkbox"/>	<input type="checkbox"/>	<input type="checkbox"/>

✓ RATE THE OVERALL QUALITY OF THIS MANUAL BY CIRCLING YOUR RESPONSE BELOW. (1) = POOR (5) = EXCELLENT

HELPFULNESS OF INDEX / TABLE OF CONTENTS	1	2	3	4	5
CLARITY	1	2	3	4	5
EASE OF USE	1	2	3	4	5
ACCURACY AND COMPLETENESS	1	2	3	4	5
QUALITY COMPARED TO OTHER COMPANIES' MANUALS	1	2	3	4	5
QUALITY COMPARED TO OTHER ALLEN-BRADLEY MANUALS	1	2	3	4	5

✓ WHAT DID YOU LIKE MOST ABOUT THIS MANUAL?

✓ WHAT DID YOU LIKE LEAST ABOUT THIS MANUAL?

✓ PLEASE LIST ANY ERRORS YOU FOUND IN THIS MANUAL (REFERENCE PAGE, TABLE, OR FIGURE NUMBERS).

✓ DO YOU HAVE ANY ADDITIONAL COMMENTS?

✓ COMPLETE THE FOLLOWING.

NAME _____ COMPANY _____

TITLE _____ DEPARTMENT _____

STREET _____ CITY _____ STATE _____ ZIP _____

TELEPHONE _____ DATE _____

CUT ALONG DOTTED LINE

FOLD HERE

FOLD HERE



BUSINESS REPLY MAIL

FIRST CLASS PERMIT NO. 413 MEQUON, WI

NO POSTAGE
NECESSARY
IF MAILED
IN THE
UNITED STATES

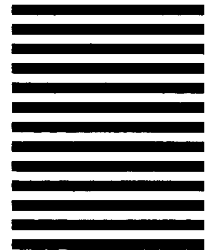

POSTAGE WILL BE PAID BY ADDRESSEE

ALLEN-BRADLEY

Attn: Marketing Communications
P.O. Box 760
Mequon, WI 53092-9907



1336 FORCE™, Drive Tools™, SCANport™ and DH+™ are trademarks of Allen-Bradley Company, Inc., a Rockwell International Company.

PLC® is a registered trademark of Allen-Bradley Company, Inc., a Rockwell International Company.

Windows™ is a trademark of Microsoft.



ALLEN-BRADLEY
A ROCKWELL INTERNATIONAL COMPANY

Allen-Bradley has been helping its customers improve productivity and quality for 90 years. We design, manufacture and support a broad range of control and automation products worldwide. They include logic processors, power and motion control devices, man-machine interfaces, sensors and a variety of software. Allen-Bradley is a subsidiary of Rockwell International, one of the world's leading technology companies.

With major offices worldwide.



Algeria • Argentina • Australia • Austria • Bahrain • Belgium • Brazil • Bulgaria • Canada • Chile • China, PRC • Colombia • Costa Rica • Croatia • Cyprus • Czech Republic • Denmark • Ecuador • Egypt • El Salvador • Finland • France • Germany • Greece • Guatemala • Honduras • Hong Kong • Hungary • Iceland • India • Indonesia • Israel • Italy • Jamaica • Japan • Jordan • Korea • Kuwait • Lebanon • Malaysia • Mexico • New Zealand • Norway • Oman • Pakistan • Peru • Philippines • Poland • Portugal • Puerto Rico • Qatar • Romania • Russia-CIS • Saudi Arabia • Singapore • Slovakia • Slovenia • South Africa, Republic • Spain • Switzerland • Taiwan • Thailand • The Netherlands • Turkey • United Arab Emirates • United Kingdom • United States • Uruguay • Venezuela • Yugoslavia

World Headquarters, Allen-Bradley, 1201 South Second Street, Milwaukee, WI 53204 USA, Tel: (1) 414 382-2000 Fax: (1) 414 382-4444