



# M100 Electronic Motor Starters

Bulletins M105, M109

Topic	Page
Overview	2
Product Overview	2
Protection Features	2
Safety Concept	2
Product Selection	7
Catalog Number Explanation	7
Product Selection	7
Accessories	8
Wiring Diagrams	9
Single- and Three-phase Wiring	9
Control Wiring Diagram	10
Specifications	14
Approximate Dimensions	17
Additional Resources	19

## Product Overview

The M100 starter is an advanced electro-mechanical motor starter that combines the functionality of a contactor and an overload relay into a smaller footprint. This starter series offers direct-on-line (DOL) and reversing electronic motor starters, with an option for SIL 3 Safe Torque Off (STO) Functional Safety. M100 starters can control single- and three-phase motors up to 480V AC and are available with maximum current ratings of 9 A and 23 A. The M100 starter has integrated electronic overload protection, which eliminates the need for a separate overload relay.

The M100 series of starters includes non-reversing, reversing, safety, and standard options, all of which have the same slim form-factor. All M100 starter options can be installed side-by-side without derating. This configuration is referred to as 'zero stacked.' Zero-stacking provides a significant reduction in the required panel space. See [Zero Stacked Configuration](#) for more information.

The M100 starter requires a 24V DC control power source and uses 24V DC control signals. For control inputs, the M100 starter is equipped with start, stop, remote reset, and reversing (when applicable). Two separate, integrated 24V DC (100 mA max load) outputs signal the M100 starter and fault status. The M100 starter safety option requires two separate 24V DC OSSD safety demands, which must be provided from a compatible safety logic device.

The M100 starter features a user interface on the front of the unit for configuration and diagnostics. Light-emitting diodes (LEDs) indicate module and motor status and reversing and STO status when applicable. With the M100 starter DIP switches, you can switch between single- and three-phase control and select auto or manual overload reset. A full load ampere (FLA) selector dial is also installed on the front of the unit, which can be used to configure the M100 starter protection features.

## Protection Features

The M100 starter offers multiple protection functions with the following options:

- Thermal overload protection with Class 10 overload trip
- Auto and manual overload reset
- Phase loss protection
- Phase imbalance protection
- Contact weld protection
- Single-phase miswiring protection
- Remote reset control input

For additional circuit protection information, see [Specifications](#).

## Safety Concept

The TÜV Rheinland group has approved the M100 starter for use in safety applications up to and including the following:

- Category 3 according to EN ISO 13849-1
- SIL 3 according to IEC 61508

As a risk reduction method, the M100 starter STO can also be used together with other components in a safety application to achieve the following:

- An overall Category 3 / PL(e) according to EN ISO 13849-1
- SIL 3 according to EN 62061 and IEC 61508

---

**IMPORTANT** The following safety requirements are based on the standards that are current at the time of certification.

---

For additional functional safety ratings, see [Functional Safety Ratings](#). For additional safety information, see the Electronic Motor Starters User Manual, publication [M100-UM001](#). For product certifications currently available from Rockwell Automation, see [rok.auto/certifications](#).

## Safety Inputs Operation

The M100 starter functional safety configuration has two safety demand inputs. For additional information, see [Specifications](#).

The M100 starter has the following three-wire control functional safety operating modes.

**Figure 1 - Functional Safety Operation Modes for Three-wire Configurations**

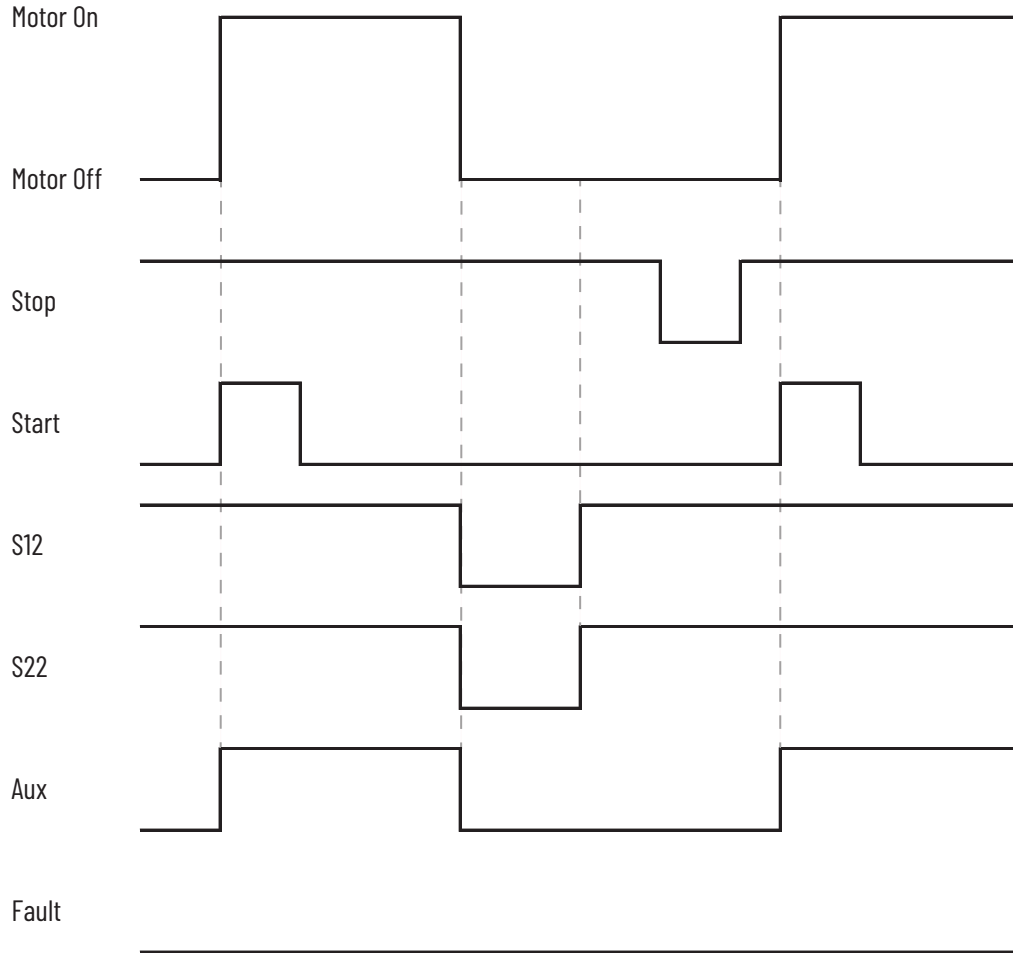

The M100 starter has the following two-wire control functional safety operating modes.

**Figure 2 - Functional Safety Operation Modes for Two-wire Configurations**

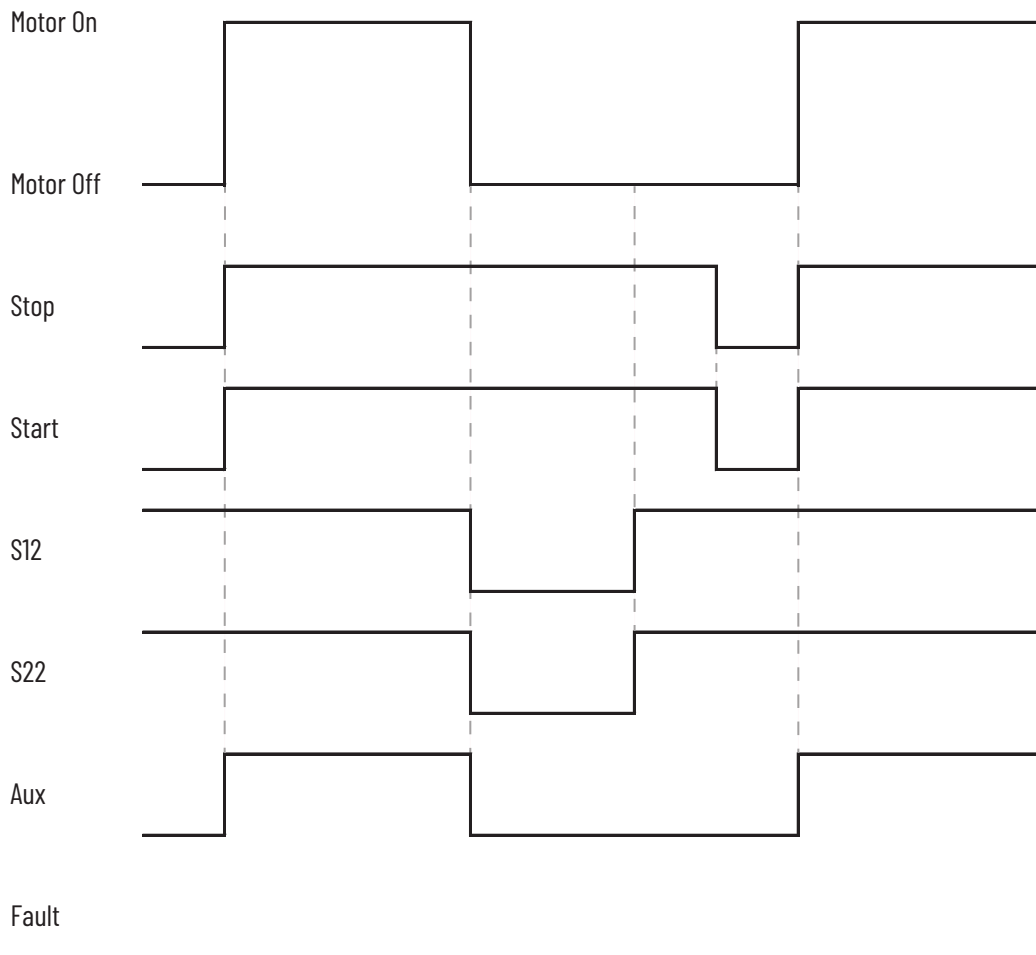

## Mounting

### Zero Stacked Configuration

The M100 starter can be mounted vertically in a zero-stacked configuration at maximum current without derating. The M100 starter is designed to be mounted in a vertical orientation, but operates correctly when mounted horizontally.

---

**IMPORTANT** If the M100 starter is mounted horizontally, do not mount additional M100 starter units in the space above or below the unit.

---

For more information, see the M100 Electronic Motor Starters User Manual, publication [M100-UM001](#).

### DIN Rail Mounting

The M100 starter uses standard 35 x 7.5 mm (1.38 x 0.30 in.) DIN Rail mounting. For additional information on mounting the M100 starter on DIN Rail, see the Installation instruction for Motor Starters, publication [M100-IN001](#).

## Connectors

The M100 starter has the following connectors.

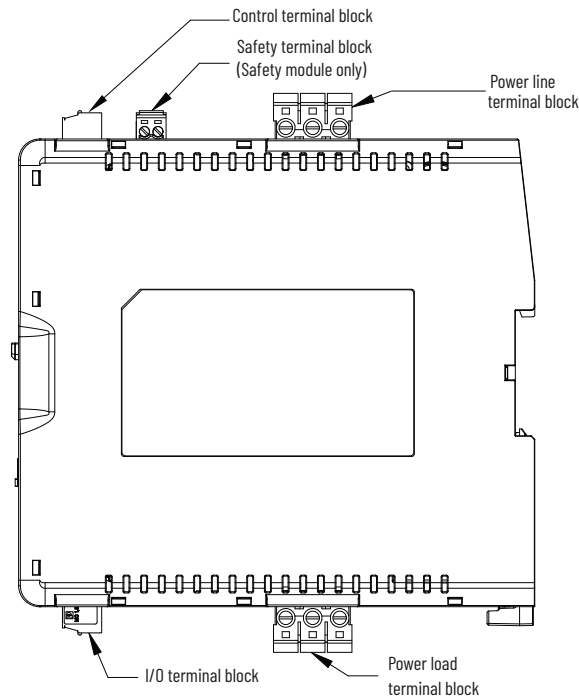

The M100 starter terminal main line and load connections support the following:

- Flexible stranded wire
- Flexible stranded wire with ferrule
- Coarse-stranded wire
- Solid wire



Only one single conductor can be used on the power and safety terminals. The control/aux terminal can use two conductors per terminal.

## Automatic Reset

The M100 starter is configured to reset the overload trips manually by default. For more information, see the Electronic Motor Starters User Manual, publication [M100-UM001](#).



**WARNING:** If the device is set to Automatic Reset, it will restart automatically. Take precautions to help prevent hazards.



**AVERTISSEMENT:** Si le dispositif est réglé en mode de réinitialisation automatique, il redémarrera automatiquement. Veuillez prendre des précautions pour prévenir les risques.

## Group Installation with MPCBs



Devices rated for 9 A (M105N/S-C09-..., M109N/S-C09-...) are Suitable for motor group applications when used on the load side of a cat. no. 140MT-D9E-C20 circuit breaker with an SCCR rating of 65 kA @ 480Y/277V.

There is only one BCPD for the "Group".

Group installation has been successfully used for many years in the U.S. and Canada. It allows “two or more motors or one or more motors and other loads to be connected to the same branch-circuit...”. The most restrictive part of the conditions that are specified for Group Installation is the requirement for the protection of the conductors for each motor circuit. In the U.S. NEC for 2002, a new rule for the conductor sizing was added for devices that are listed and marked “Suitable for use as Tap Conductor Protection”.

Figure 3 shows an example that illustrates installations involving multiple motors with a single BCPD protecting the entire “Group”.

Bulletin 140MT MPCBs are UL/CSA Listed for Group Installation: conductors from the BCPD to each motor must be a minimum of 1/3 the ampacity of the Branch Circuit conductors.

Bulletin 140MT MPCBs are UL/CSA Listed for Tap conductor Protection in Group Installations: conductors from the BCPD to manual motor controller listed as “...Tap Conductor Protection...” must be minimum of 1/10 the rating or setting of the BCPD. Conductors from the controller to the motor must be 125% of the motor FLA.

Figure 3 - Group Installation with MPCBs

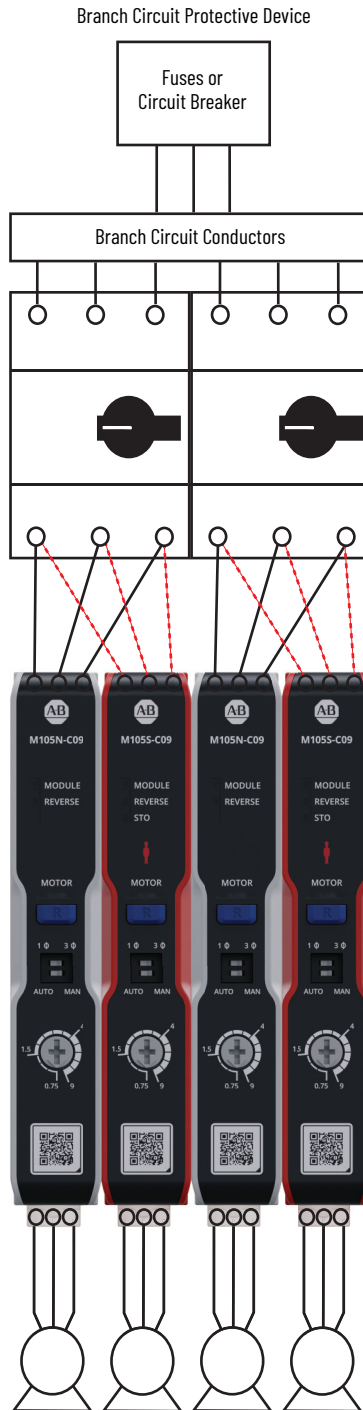

## Catalog Number Explanation

The examples that are provided in this section are not intended to be used for product selection. Not all combinations produce a valid catalog number. Use ProposalWorks™ software to configure the M100 starter. ProposalWorks software is available from [rok.auto/systemtools](http://rok.auto/systemtools).

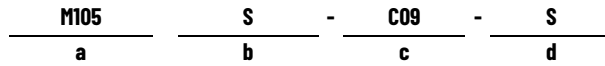

a		b		c		d	
Bulletin Number		Safety		Current Range		Terminals	
Code	Description	Code	Description	Code	Description	Code	Description
M105	M100 reversing starter	N	No functional safety	C09	0.75...9 A	S	Screw terminals
M109	M100 non-reversing starter	S	Functional safety	C23	4.6...23 A	P	Push-in terminals

For a list of available M100 starter accessories, see [Accessories](#).

## Product Selection

Table 1 - Product Selection

Current Range [A]	Reversing / Non-reversing	Safety	Terminals	Cat. No.
0.75...9 A	Reversing	No functional safety	Screw terminals	M105N-C09-S
			Push-in terminals	M105N-C09-P
		Functional safety	Screw terminals	M105S-C09-S
			Push-in terminals	M105S-C09-P
	Non-reversing	No functional safety	Screw terminals	M109N-C09-S
			Push-in terminals	M109N-C09-P
		Functional safety	Screw terminals	M109S-C09-S
			Push-in terminals	M109S-C09-P
4.6...23 A	Reversing	No functional safety	Screw terminals	M105N-C23-S
			Push-in terminals	M105N-C23-P
		Functional safety	Screw terminals	M105S-C23-S
			Push-in terminals	M105S-C23-P
	Non-reversing	No functional safety	Screw terminals	M109N-C23-S
			Push-in terminals	M109N-C23-P
		Functional safety	Screw terminals	M109S-C23-S
			Push-in terminals	M109S-C23-P

The M100 starter ships with terminal block kits. The following accessory kits are intended to be used as spare or replacement terminal blocks.

**Table 2 - Terminal Block Kits**

Current Range [A]	Reversing / Non-reversing	Safety	Terminals	Cat. No.
0.75...9A	Reversing	No functional safety	Screw terminals	M105N-C09-S-TB
			Push-in terminals	M105N-C09-P-TB
		Functional safety	Screw terminals	M105S-C09-S-TB
			Push-in terminals	M105S-C09-P-TB
	Non-reversing	No functional safety	Screw terminals	M109N-C09-S-TB
			Push-in terminals	M109N-C09-P-TB
		Functional safety	Screw terminals	M109S-C09-S-TB
			Push-in terminals	M109S-C09-P-TB
4.6...23 A	Reversing	No functional safety	Screw terminals	M105N-C23-S-TB
			Push-in terminals	M105N-C23-P-TB
		Functional safety	Screw terminals	M105S-C23-S-TB
			Push-in terminals	M105S-C23-P-TB
	Non-reversing	No functional safety	Screw terminals	M109N-C23-S-TB
			Push-in terminals	M109N-C23-P-TB
		Functional safety	Screw terminals	M109S-C23-S-TB
			Push-in terminals	M109S-C23-P-TB



## Single- and Three-phase Wiring

Figure 4 - Three-phase Wiring Diagram

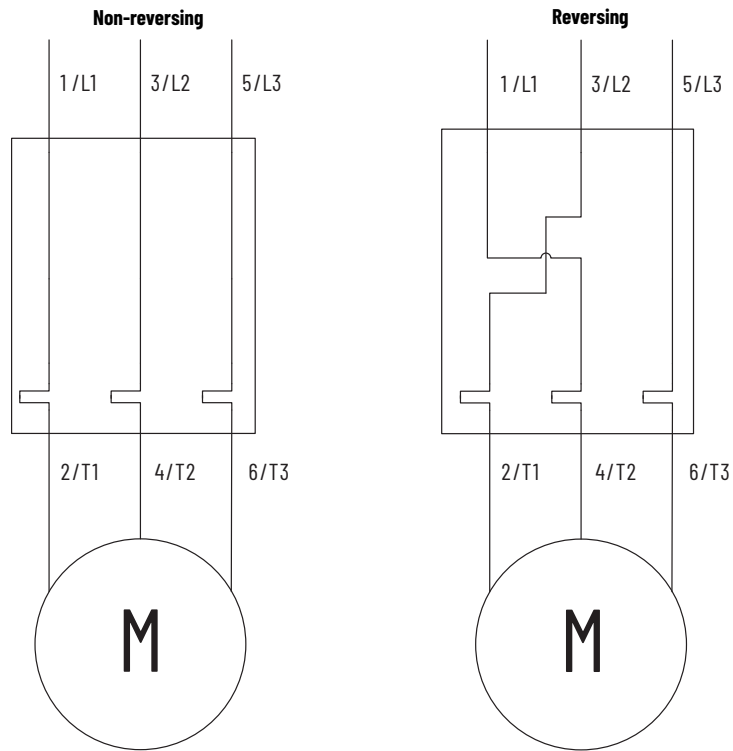
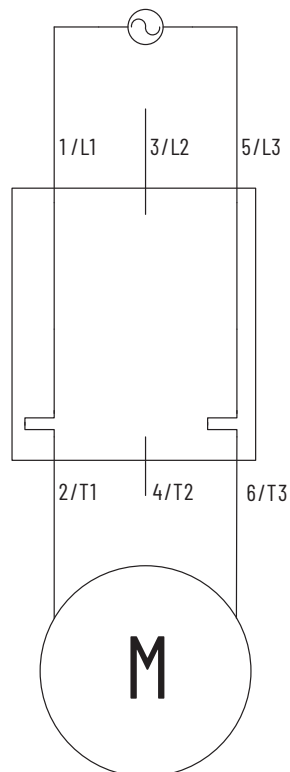

Figure 5 - Single-phase Wiring Diagram



## Control Wiring Diagram

Figure 6 - Three-wire Control with OSSD Functional Safety Devices – Remote Reset, Reversing, Auxiliary

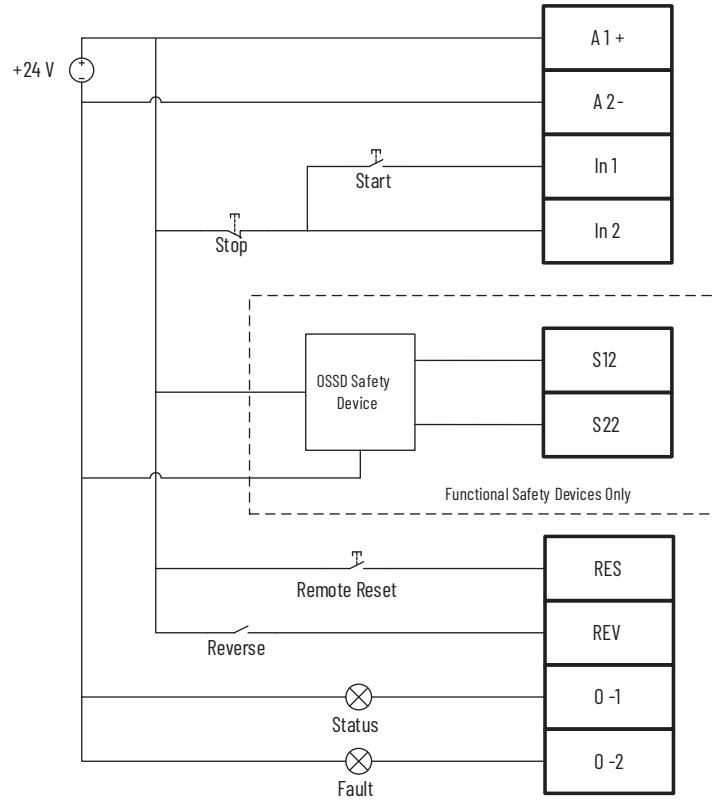
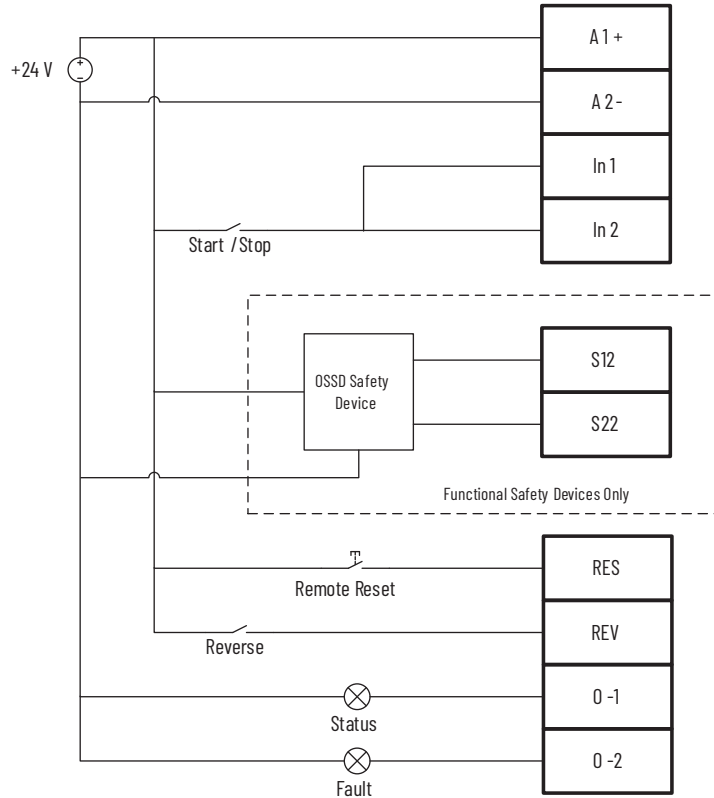

Figure 7 - Two-wire Control with OSSD Functional Safety Devices – Remote Reset, Reversing, Auxiliary Outputs



# Trip Curves

Figure 8 - Trip Curves – 9 A

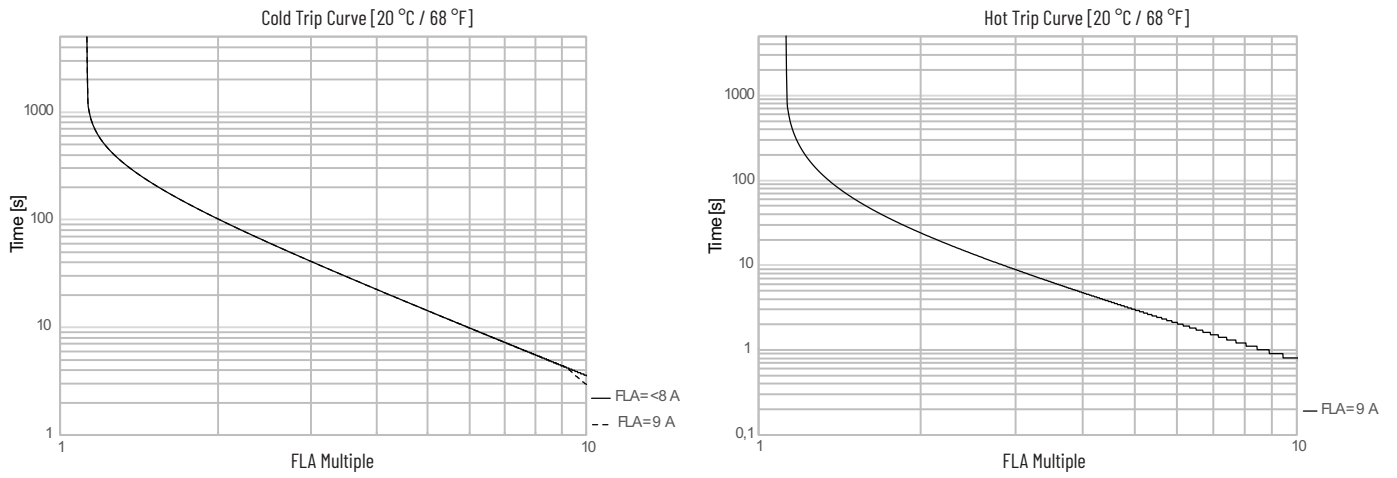

Figure 9 - Trip Curves – 23 A

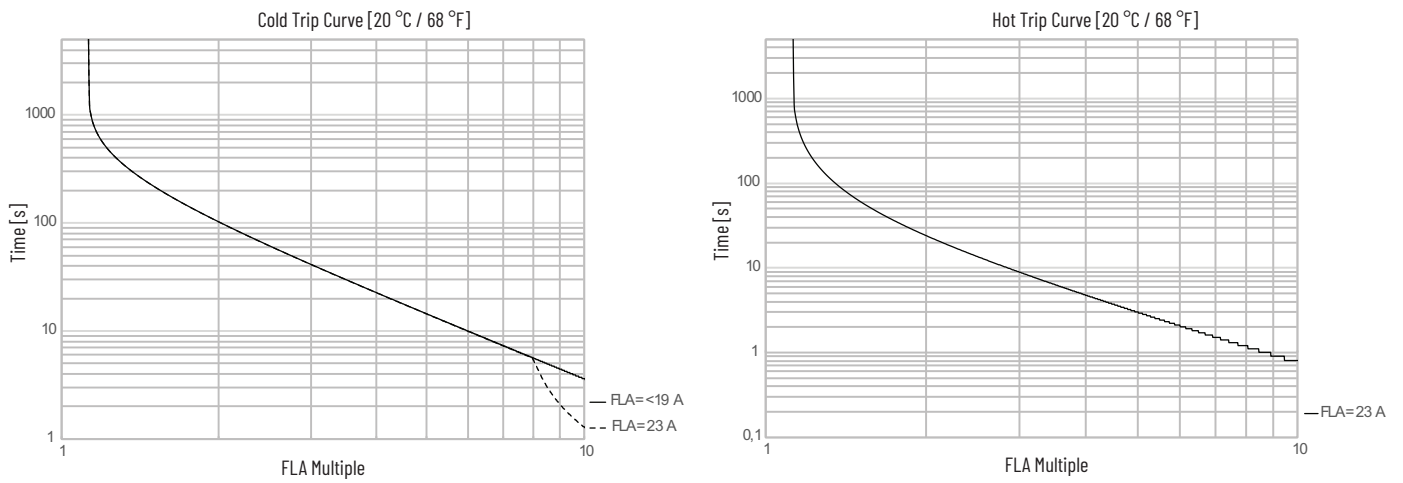

Figure 10 - Maximum Starts per Minute @ 20 °C (68 °F) – 9 A and 23 A Devices, 80% FLA

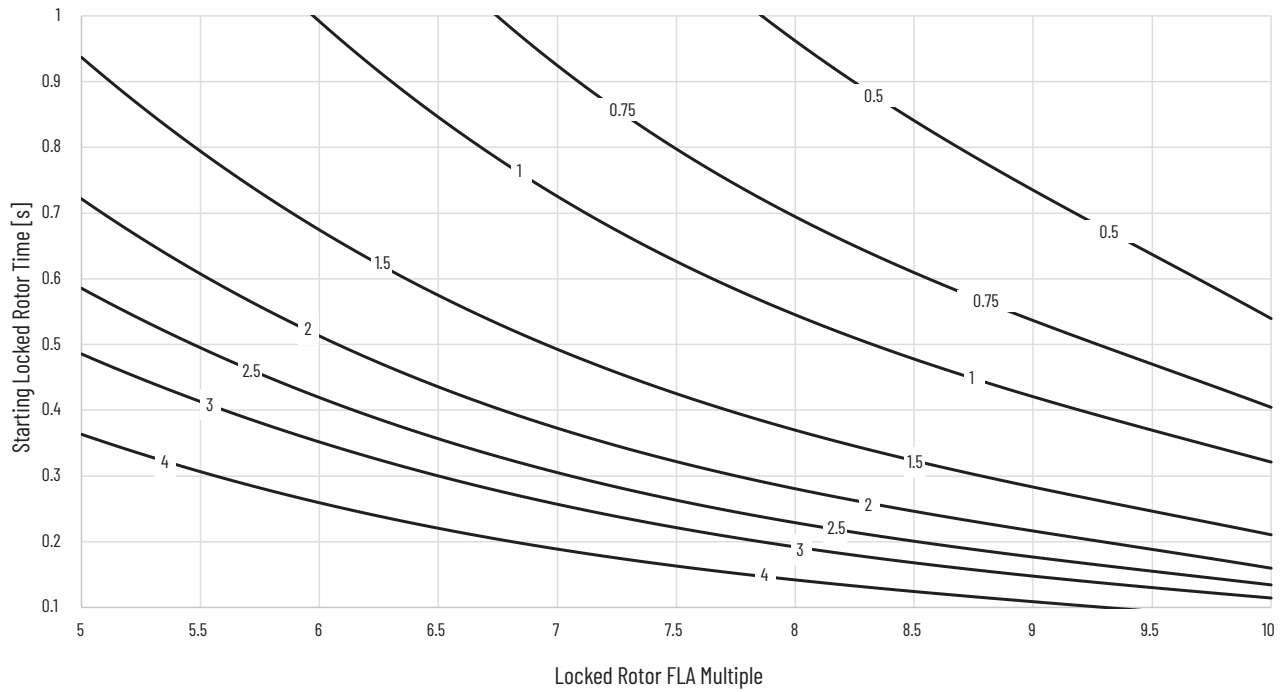

Figure 11 - Maximum Starts per Minute @ 20 °C (68 °F) – 9 A and 23 A Devices, 100% FLA

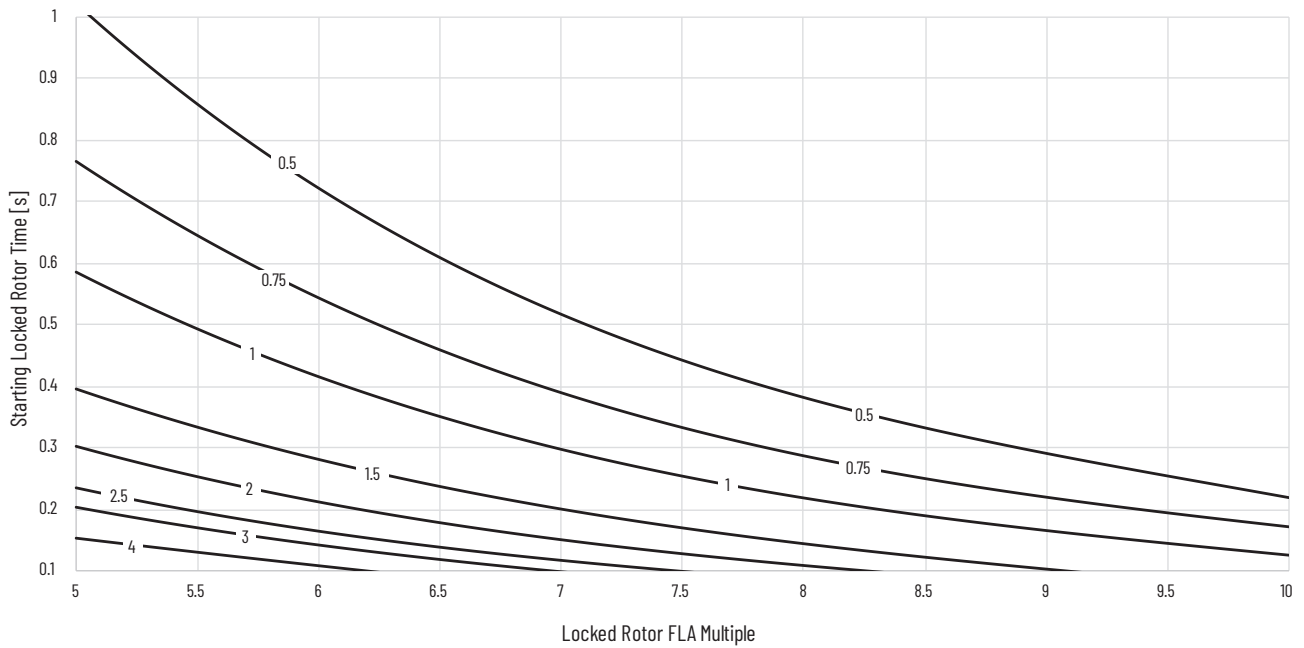
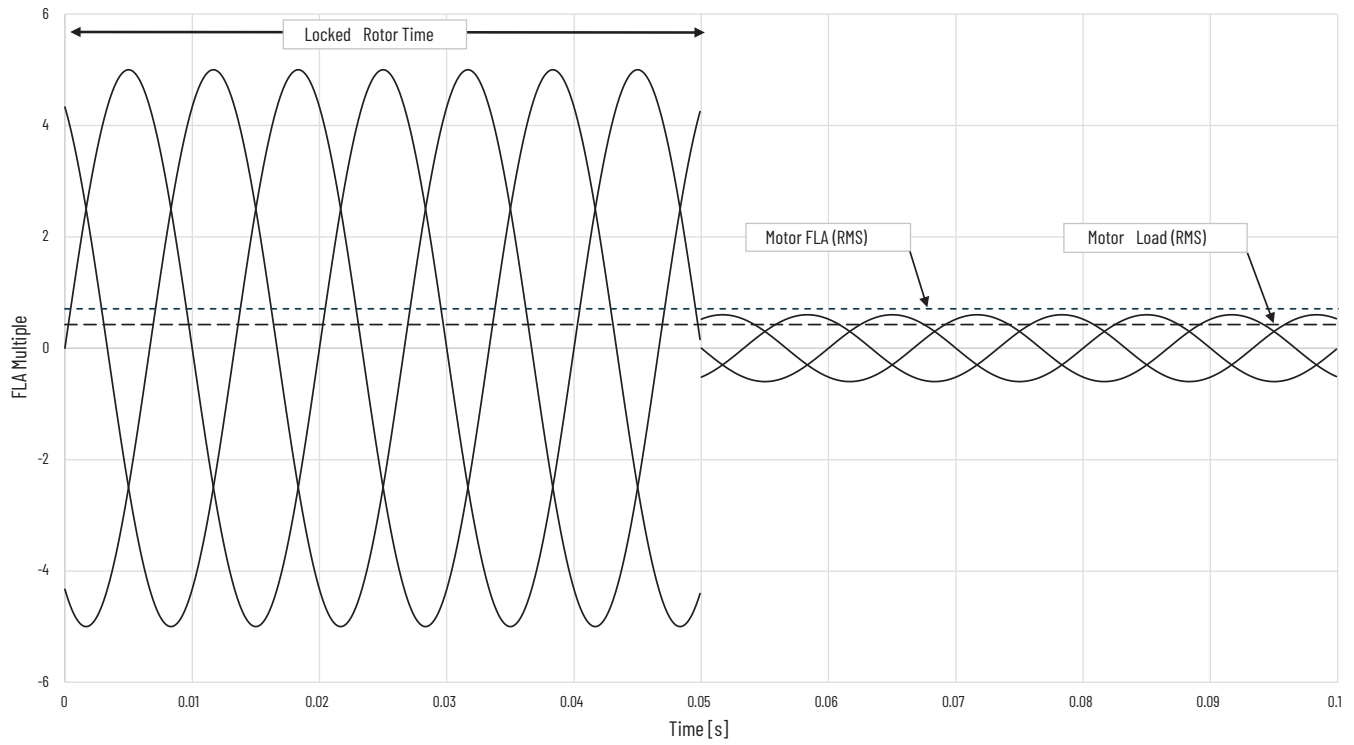

Figure 12 - Simplified Motor Start



**Table 3 - General Ratings**

Attribute		Value
Standards compliance		<ul style="list-style-type: none"> <li>UL 60947-4-1</li> <li>CSA C22.2, No. 60947-4-1</li> <li>EN 60947-4-1</li> <li>NM EN 60947-4-1</li> </ul> For more information, see <a href="#">Table 4</a> .
Certifications		<ul style="list-style-type: none"> <li>cULus, CE, UKCA, Morocco, RCM</li> </ul> For more information, see <a href="#">Table 4</a> . For additional product certifications currently available from Rockwell Automation, see <a href="http://rok.auto/certifications">rok.auto/certifications</a>
Number of safety demand inputs		2
Safety input type		24V DC ( $U_e$ ) type 1 rated inputs, as defined in EN 60947-1
Rated operating current	9 A configuration	0.75...9 A
	23 A configuration	4.6...23 A
Control voltage power source requirements <sup>(1)</sup>	9 A devices	24V DC (-15% / +10%) control power source on the A1+/A2-terminals For functional safety applications, see <a href="#">Table 4</a> .
	23 A devices	
Rated operating voltage $U_e$		480V AC
Maximum operating voltage		480V AC
Rated insulation voltage $U_i$		500V
Rated impulse withstand voltage $U_{imp}$		6 kV
Rated frequency		50/60 Hz
Trip class		10
Utilization category		AC-3
Number of operations		1,000,000 (AC-3)
Temperature	Storage temperature range	-40...+85 °C (-40...+185 °F)
	Ambient temperature range	-20...+55 °C (-4...+131 °F)
	Surrounding air temperature range	-20...+65 °C (-4...+149 °F)
Humidity	Operating	5...95% noncondensing 92% relative humidity
	Damp Heat - Steady State Per IEC 60068-2-78	93% relative humidity 40 °C (104 °F) 56 days
	Damp Heat - Cyclic Per IEC 60068-2-30	93% relative humidity 25 °C/40 °C (77 °F/104 °F) 21 Cycles
Cooling Method		Natural convection
Resistance to Vibration Per IEC 60068-2-6	9 A configuration	Operating 3 G
	23 A configuration	
Resistance to Shock Per IEC 60068-2-27	9 A configuration	15 G Operating 30 G Nonoperating
	23 A configuration	15 G Operating 25 G Nonoperating
Maximum altitude		2000 m (6561 ft)
Pollution environment		Pollution Degree 3
Mounting		Vertical mounting Recommended See Electronic Motor Starters User Manual, publication <a href="#">M100-UM001</a> .
Minimum distance to other units, same type		Zero-stack capability
Degree of protection		IP20 with terminal blocks installed
Minimum enclosure size	9 A configuration	406 x 305 x 203 mm (16 x 12 x 8 in.)
	23 A configuration	

(1) The M100 starter is designed with internal overcurrent protection to limit the maximum energy into the control circuit.

**Table 4 - Functional Safety Ratings<sup>(1)</sup>**



Attribute		Rating
Safety integrity level (SIL) of 3		IEC 61508
Designated architecture Category 3		(EN) ISO 13849-1 Standard
Suitable for use in SIL 3		IEC/EN 62061 Standard
Suitable for use in Performance Level e (PLe)		(EN) ISO 13849-1 Standard
PFH	9 A Devices	5.31E-09
	23 A Devices	4.04E-09
HFT		1(1oo2)
PTI		20 years
Hardware type		Type A
Safety demand validation interval		1 month
M100 starter control power source		<ul style="list-style-type: none"> <li>• 24V DC SELV/PELV</li> <li>• Fault Voltage = 60V</li> <li>• Connected to the M100 starter A1+ and A2-terminals</li> <li>• Conforms to the SELV/PELV requirements of IEC 60364-4-41</li> <li>• 60V maximum, including ripple, isolation, and noise</li> </ul>
Mounting		Inside an enclosure rated to a minimum of IP54
Mode of Operation		High Demand

(1) For product certifications currently available from Rockwell Automation, see [rok.auto/certifications](http://rok.auto/certifications).

**Table 5 - Fault Ratings**

Rating	Protection Type	Attribute	9 A Starters	23 A Starters
UL Standard Fault	Fuse or circuit breaker	Max Fuse [A]	35 (Class RK5)	90 (Class J)
		Max Circuit Breaker [A]	30 (Bulletin 140UT)	
		Standard Fault Current [kA]	1	3
UL High Fault	Fuse	Max Class J Fuse [A]	35	60
		Max Class CC Fuse [A]	30	–
		High Fault Current [kA]	100	
	Circuit breaker	Max Circuit Breaker [A]	30	
		High Fault Current [kA]	65	
		Recommended Circuit Breaker (480Y/277V)	Cat. No. 140UT-D7D3-C30	

**Table 6 - Wiring and Torque Specifications**

Connection				Screw Terminals						Push-in Terminals							
				Power Terminals <sup>(1)</sup>		Control/Auxiliary Terminals		Safety Terminals		Power Terminals <sup>(1)</sup>		Control/Auxiliary Terminals		Safety Terminals			
				9 A	23 A	9 A	23 A	9 A	23 A	9 A	23 A	9 A	23 A	9 A	23 A		
Wiring	Solid		1 conductor	mm <sup>2</sup>	2.5...4	2.5...6	1...2.5		0.5...1.5		2.5...4	2.5...6	1...2.5		0.5...1.5		
			AWG	14...12	14...10	18...14		28...16		14...12	14...10	18...14		28...16			
		2 conductors	mm <sup>2</sup>	—	—	1...1.5		—	—	—	—	1...2.5		—	—		
		AWG	—	—	18...16		—	—	—	—	18...16		—	—			
	Stranded <sup>(2)</sup>		1 conductor	mm <sup>2</sup>	2.5...4	2.5...6	1...2.5		0.5...1.5		2.5...4	2.5...6	1...2.5		0.5...1.5		
			AWG	14...12	14...10	18...14		28...16		14...12	14...10	18...14		28...16			
		2 conductors	mm <sup>2</sup>	—	—	1...1.5		—	—	—	—	1...1.5		—	—		
		AWG	—	—	18...16		—	—	—	—	18...16		—	—			
Stripping length				9 mm (0.35 in.)		9 mm (0.35 in.)		9 mm (0.35 in.)		9 mm (0.35 in.)		9 mm (0.35 in.)		9 mm (0.35 in.)			
Recommended screwdriver				3 mm (1/8 in.)		3 mm (1/8 in.)		3 mm (1/8 in.)		Push button	0.6 x 3.5 mm (0.02 x 0.14 in.)	0.4 x 2.5 mm (0.02 x 0.1 in.)		0.4 x 2.5 mm (0.02 x 0.1 in.)			
Tightening torque				N•m		0.4...0.5		0.5...0.6		0.22...0.25		0.22...0.25		—			
				lb•in		3.5...4.4		4.4...5.3		1.95...2.21		1.95...2.21					

(1) Power terminals allow only one conductor per terminal (line and load sides).

(2) Main line and load connections support flexible stranded wire, flexible stranded wire with ferrule, or coarse-stranded wire.

For more information on wiring terminal installation and specifications, see the Installation Instructions for Motor Starters, publication [M100-IN001](#).



## Approximate Dimensions

Dimensions are in millimeters (inches). Dimensions are not intended to be used for manufacturing purposes.

**Figure 13 - Approximate Dimensions**

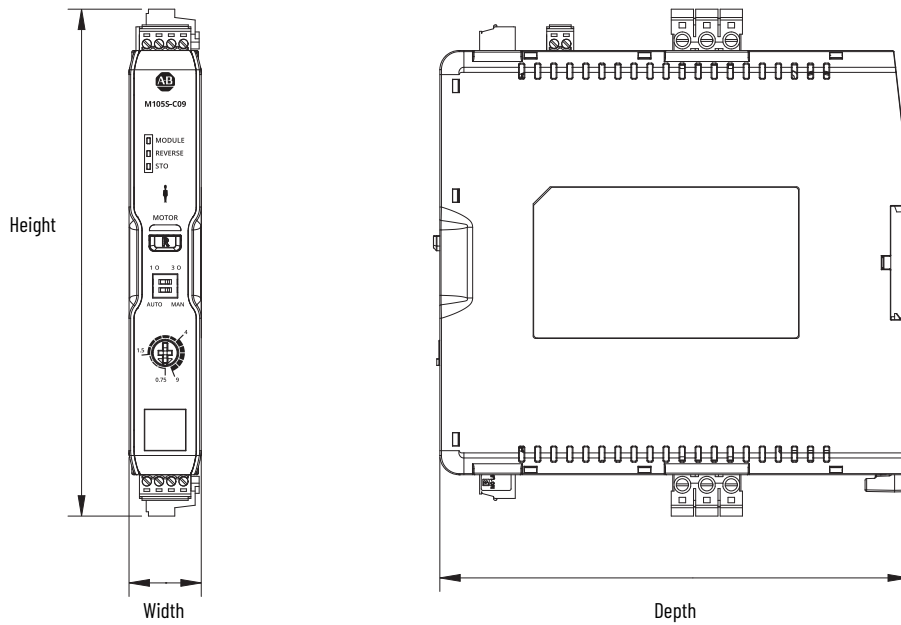

**Table 7 - Approximate Dimensions**

Starter Size	Height [mm (in.)]	Width [mm (in.)]	Depth [mm (in.)]
9 A	158.1 (6.22)	22.5 (0.89)	148 (5.83)
23 A	180.6 (7.11)	45 (1.77)	168.7 (6.64)



## Additional Resources

These documents contain additional information concerning related products from Rockwell Automation. You can view or download publications at [rok.auto/literature](http://rok.auto/literature).

Resource	Description
Installation instruction for Motor Starters, publication <a href="#">M100-IN001</a>	This publication provides information on how to install the M100 Electronic Starter.
Electronic Motor Starters User Manual, publication <a href="#">M100-UM001</a>	This publication provides information on how to install, program, and use the M100 Electronic Starter.
Motor Protection Circuit Breaker and Motor Circuit Protector Specifications, publication <a href="#">140-TD005</a>	Provides product selection and specification information for the Bulletin 140MP and 140MT lines of motor protection devices.
Short-circuit Current Ratings and Your Industrial Control Panel, publication <a href="#">SCCR-AT002</a>	Provides examples for short-circuit current ratings of panels that are based on the methods that are stated in UL 508A Supplement B.
EtherNet/IP™ Network Devices User Manual, publication <a href="#">ENET-UM006</a>	Describes how to configure and use EtherNet/IP devices to communicate on the EtherNet/IP network.
Ethernet Reference Manual, publication <a href="#">ENET-RM002</a>	Describes basic Ethernet concepts, infrastructure components, and infrastructure features.
System Security Design Guidelines Reference Manual, publication <a href="#">SECURE-RM001</a>	Provides guidance on how to conduct security assessments, implement Rockwell Automation products in a secure system, harden the control system, manage user access, and dispose of equipment.
American Standards, Configurations, and Ratings: Introduction to Motor Circuit Design, publication <a href="#">IC-AT001</a>	Provides an overview of American motor circuit design based on methods that are outlined in the NEC.
Industrial Components Preventive Maintenance, Enclosures, and Contact Ratings Specifications, publication <a href="#">IC-TD002</a>	Provides a quick reference tool for Allen-Bradley® industrial automation controls and assemblies.
Industrial Automation Wiring and Grounding Guidelines, publication <a href="#">1770-4.1</a>	Provides general guidelines for installing a Rockwell Automation industrial system.
Product Selection and Configuration tools, <a href="http://rok.auto/systemtools">rok.auto/systemtools</a>	Helps configure complete, valid catalog numbers and build complete quotes based on detailed product information.
Rockwell Automation Global SCCR tool, <a href="http://rok.auto/sccr">rok.auto/sccr</a>	Provides coordinated high-fault branch circuit solutions for motor starters, soft starters, and component drives.
Product Certifications website, <a href="http://rok.auto/certifications">rok.auto/certifications</a>	Provides declarations of conformity, certificates, and other certification details.

# Rockwell Automation Support

Use these resources to access support information.

<b>Technical Support Center</b>	Find help with how-to videos, FAQs, chat, user forums, Knowledgebase, and product notification updates.	<a href="http://rok.auto/support">rok.auto/support</a>
<b>Local Technical Support Phone Numbers</b>	Locate the telephone number for your country.	<a href="http://rok.auto/phonesupport">rok.auto/phonesupport</a>
<b>Technical Documentation Center</b>	Quickly access and download technical specifications, installation instructions, and user manuals.	<a href="http://rok.auto/techdocs">rok.auto/techdocs</a>
<b>Literature Library</b>	Find installation instructions, manuals, brochures, and technical data publications.	<a href="http://rok.auto/literature">rok.auto/literature</a>
<b>Product Compatibility and Download Center (PCDC)</b>	Download firmware, associated files (such as AOP, EDS, and DTM), and access product release notes.	<a href="http://rok.auto/pcdc">rok.auto/pcdc</a>

## Documentation Feedback

Your comments help us serve your documentation needs better. If you have any suggestions on how to improve our content, complete the form at [rok.auto/docfeedback](http://rok.auto/docfeedback).

Allen-Bradley, expanding human possibility, and Rockwell Automation are trademarks of Rockwell Automation, Inc.





EtherNet/IP is a trademark of ODVA, Inc.

Trademarks not belonging to Rockwell Automation are property of their respective companies.

Rockwell Automation maintains current product environmental compliance information on its website at [rok.auto/pec](http://rok.auto/pec).

Rockwell Automation NV Commercial Registration Number 0424.293.935

Rockwell Otomasyon Ticaret A.Ş. Kar Plaza İş Merkezi E Blok Kat:6 34752, İçerenköy, İstanbul, Tel: +90 (216) 5698400 EEE Yönetmeliğine Uygundur

Connect with us.    

**rockwellautomation.com** ————— **expanding human possibility®**

AMERICAS: Rockwell Automation, 1201 South Second Street, Milwaukee, WI 53204-2496 USA, Tel: (1) 414.382.2000

EUROPE/MIDDLE EAST/AFRICA: Rockwell Automation NV, Pegasus Park, De Kleetlaan 12a, 1831 Diegem, Belgium, Tel: (32) 2663 0600

ASIA PACIFIC: Rockwell Automation SEA Pte Ltd, 2 Corporation Road, #04-05, Main Lobby, Corporation Place, Singapore 618494, Tel: (65) 6510 6608

UNITED KINGDOM: Rockwell Automation Ltd., Pitfield, Kiln Farm, Milton Keynes, MK11 3DR, United Kingdom, Tel: (44)(1908) 838-800

Publication M100-TD001A-EN-P - February 2025

Copyright © 2025 Rockwell Automation, Inc. All rights reserved. Printed in the U.S.A.