

42JB VisiSight M20B Photoelectric Sensor

Catalog Numbers 42JB-D2MNA1-xx, 42JB-D2MPA1-xx, 42JB-B2MNB1-xx, 42JB-B2MPB1-xx, 42JB-B2MNB2-xx, 42JB-B2MPB2-xx, 42JB-B2MNA3-xx, 42JB-B2MPA3-xx, 42JB-N2MNA1-xx, 42JB-N2MPA1-xx, 42JB-P2MNB1-xx, 42JB-P2MPB1-xx, 42JB-P2MNA1-xx, 42JB-P2MPA1-xx, 42JB-C2MNA1-xx, 42JB-C2MPA1-xx, 42JB-E2EZB1-xx, 42JB-E2EZB2-xx, 42JB-R2MNB1-xx, 42JB-R2MPB1-xx, 42JB-R2MNB2-xx, 42JB-R2MPB2-xx

Topic	Page
Overview	1
Specifications	1
Product Selection	2
Status Indicators and User Interface	3
Wiring	3
Typical Response Curves	4
Approximate Dimensions	7
Accessories	7

Overview

The Allen-Bradley® VisiSight™ M20B family offers a wide range of sensing modes and an adjustment knob that simplifies sensitivity adjustment for maximum application flexibility.

The VisiSight sensor offers an industry standard 20 mm (0.79 in.) depth housing ideal for compact housing installations.

Available Models

- Polarized retroreflective
- Transmitted beam
- Background suppression
- Background reflection
- Diffuse
- Clear object detection

Features

- 360° highly visible operation status indicators
- Visible light source offered on select models for ease of alignment
- Industry standard 25.4 mm (1 in.) side mounting holes
- Embedded IO-Link 1.1 communication protocol with enhanced parameters
- Input to disable light source on transmitted beam emitter
- IP67 rated enclosure
- -40...+65 °C (-40...+149 °F) operating temperatures

Specifications

Attribute	Value
Certifications	CE Marked for all applicable directives, cULus Listed, KCC, RCM, UKCA Marked for all applicable regulations
EMC Directive	EN 60947-5-2
Standards	UL 60947-5-2
Ambient light immunity	EN 60697-5-2:2007+A:2012
For declarations of conformity and certification details, visit rok.auto/certifications .	
Functional Safety Parameters	
MTTFd	860 a
User Interface	
Status indicators	Green and orange
Adjustments	Adjustment knob depending on catalog number
Optical	
Light-emitting diode (LED)	Visible red on all models
Electrical	
Operating voltage	10...30V DC
Current consumption	Less than 35 mA
Sensor protection	Reverse polarity and short circuit
Output	
Output type	PNP or NPN by catalog number
Output mode	Light and dark operate
Response Time	
Diffuse, max	0.5 ms
Transmitted beam, max	0.5 ms
Polarized retroreflective, max	0.5 ms
Clear object detection, max	0.5 ms
Background suppression, max	0.66 ms
Background reflection, max	0.66 ms
Load Current	
Resistive load	100 mA, max
Mechanical	
Housing material	ABS
Lens material	Acrylic
Environmental	
Enclosure rating	IP67
Operating temperature	-40...+65 °C (-40...+149 °F)

Product Selection

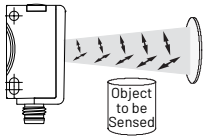
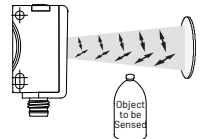
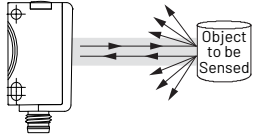
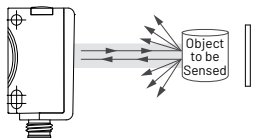
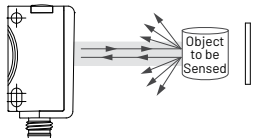
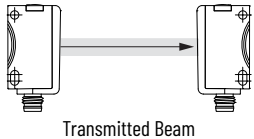
Sensing Mode	Light Source	Sensing Distance	Sensitivity Adjustment	Output Function	Output Type	Cat. No.
 <p>Polarized Retroreflective</p>	Visible red	6 m with 92-125 reflector	No adjustment knob	Complementary light and dark operate	NPN	42JB-P2MNB1-F4
			Adjustment knob		PNP	42JB-P2MPB1-F4
					NPN	42JB-P2MNA1-F4
			PNP		42JB-P2MPA1-F4	
 <p>Clear Object Detection</p>	Visible red	3 m with 92-125 reflector	Adjustment knob	Complementary light and dark operate	NPN	42JB-C2MNA1-F4
					PNP	42JB-C2MPA1-F4
 <p>Diffuse</p>	Visible red	10...1.5 m	Adjustment knob	Complementary light and dark operate	NPN	42JB-D2MNA1-F4
					PNP	42JB-D2MPA1-F4
 <p>Background Suppression</p>	Visible red	50 mm	No adjustment knob	Complementary light and dark operate	NPN	42JB-B2MNB1-F4
		Visible red			100 mm	PNP
	250 mm		NPN		42JB-B2MNB2-F4	
			PNP		42JB-B2MPB2-F4	
	Adjustment knob		NPN		42JB-B2MNA3-F4	
		PNP	42JB-B2MPA3-F4			
 <p>Background Reflection</p>	Visible red	250 mm	Adjustment knob	Complementary light and dark operate	NPN	42JB-N2MNA1-F4
					PNP	42JB-N2MPA1-F4
 <p>Transmitted Beam</p>	Visible red	25000 mm	No adjustment knob - Freq 1	—	—	42JB-E2EZB1-F4
			Adjustment knob - Freq 1	Complementary light and dark operate	NPN	42JB-R2MNB1-F4
					PNP	42JB-R2MPB1-F4
			No adjustment knob - Freq 2	—	—	42JB-E2EZB2-F4
			Adjustment knob - Freq 2	Complementary light and dark operate	NPN	42JB-R2MNB2-F4
PNP	42JB-R2MPB2-F4					

IMPORTANT

Connection Options ⁽¹⁾: The following suffixes describe the available connection options:

- P4: Describes an integral 4-pin DC Pico (M8) quick-disconnect.
- F4: Describes a 4-pin DC micro (M12) quick-disconnect on a 150 mm (6 in.) length pigtail on DC models.
- A2: Describes a 2 m (6.6 ft) PVC cable.

(1) Additional connection options may be available. See the ProposalWorks™ tool for available options by sensing mode.

Status Indicators and User Interface

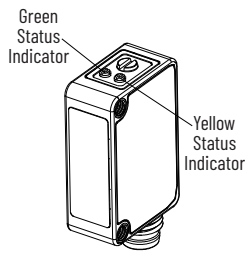

The following tables provide indicator status in the Run mode during operation. The sensor is always in Run mode except when being taught.

Table 1 - Standard I/O Operating Mode Indication

Color	Status	Description
Green	OFF	Power is OFF
	ON	Power is ON
	Flashing (6 Hz)	Unstable light: $0.8 X < \text{margin} < 1.5 X$
	Flashing (1.4 Hz)	Output short circuit protection active
Orange	OFF	Output de-energized
	ON	Output energized

Table 2 - IO-Link Operation Mode Indication

Color	Status	Description
Green	OFF	Power is OFF
	Flashing (1 Hz)	Power is ON
Orange	OFF	Output de-energized
	ON	Output energized

The green status indicator can also serve as a setup alignment aid. As the sensor is adjusted:

- A flashing green indicator shows that the sensor has detected a margin of $0.8 X$
- A flashing green indicator and steady orange output indicator shows a margin greater than 1
- Steady green and orange indicators show a margin greater than 1.5. This status means that the sensor is receiving at least 1.5 times the signal strength back from the target that is required to trigger an output signal.

In general, it is desirable to have a higher margin to help overcome any deteriorating environmental conditions (dust build-up on the sensor lens). When aligning the sensor, the optimum performance can be obtained if this margin indicator is illuminated with the target in place.

Wiring

The quick-disconnect connector is shown in the following diagrams. The pin numbers correspond to plug connectors on the sensor.

Figure 1 - Micro (M12) Plug QD on Pigtail and Integral Pico (M8) Plug QD Pinout

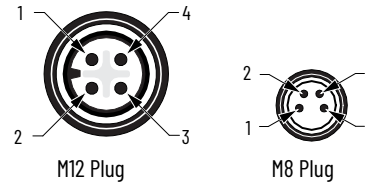

Output Wiring

Figure 2 - PNP Complementary Models

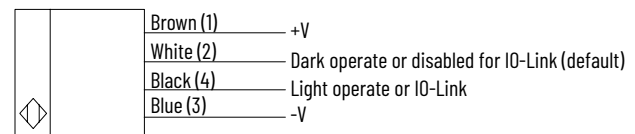
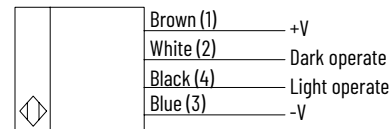
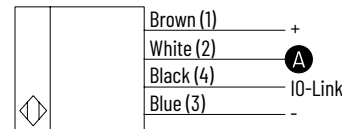

Figure 3 - NPN Complementary Models



Transmitted Beam Emitter



Item	Description
A	For normal operation, the black wire (Pin 4) needs no connection. To deactivate the light source, connect the black wire (Pin 4) to +V.

The IO-Link output Pin 4 (black) does not support the connection of multiple sensors in series (for example, one sensor powers the next sensor). The connection of multiple sensors in series can be achieved when using Pin 2 (white) outputs or by ordering a non-IO-Link catalog number.

Visit rok.auto/knowledgebase or contact your local Allen-Bradley distributor or Rockwell Automation sales office for specific ordering information.

Typical Response Curves

Diffuse

Figure 4 - 1.5 m (4.9 ft) Sensing Distance - Margin Curve

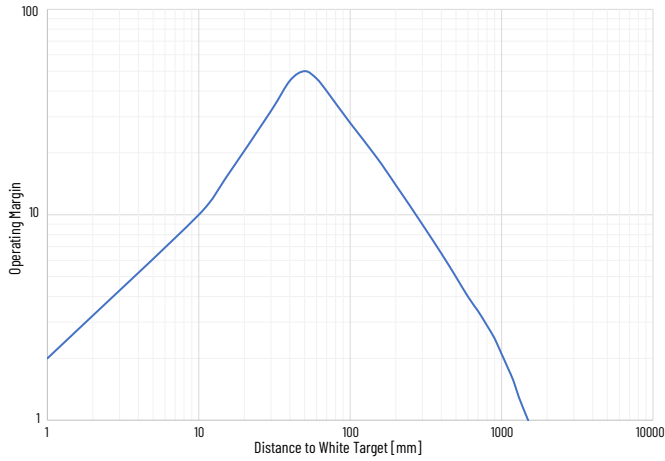
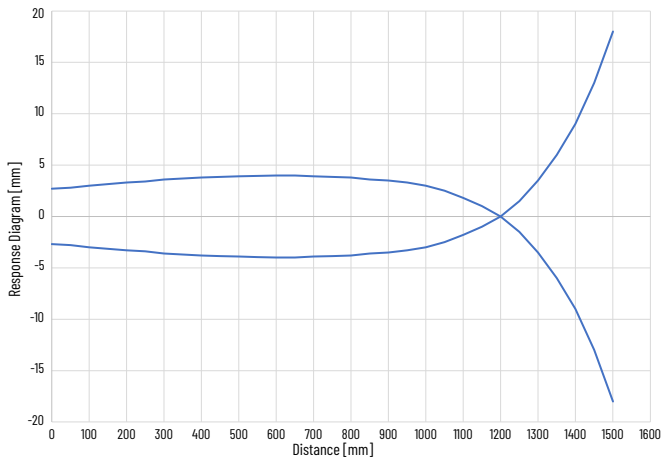

Figure 5 - 1.5 m (4.9 ft) Sensing Distance - Beam Pattern



Polarized Retroreflective

Figure 6 - 6 m (19.7 ft) Sensing Range - Margin Curve

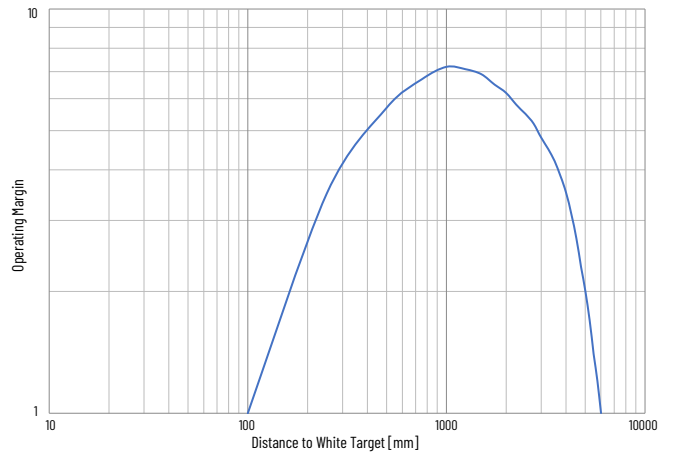
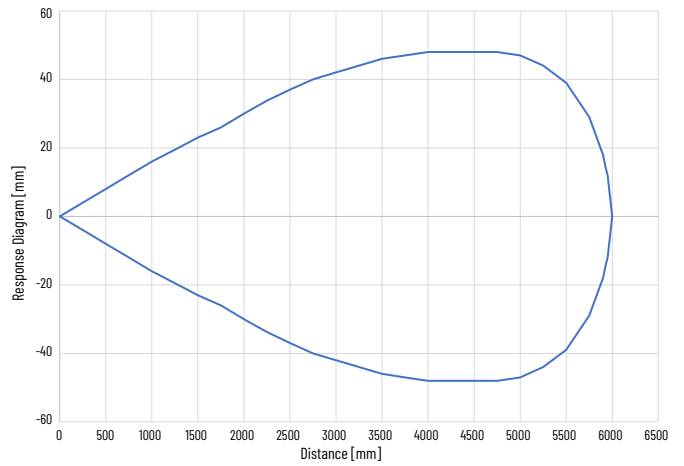

Figure 7 - 6 m (19.7 ft) Sensing Range - Beam Pattern



Background Suppression

Figure 8 - 50 mm (1.97 in.) Sensing Range - Margin Curves

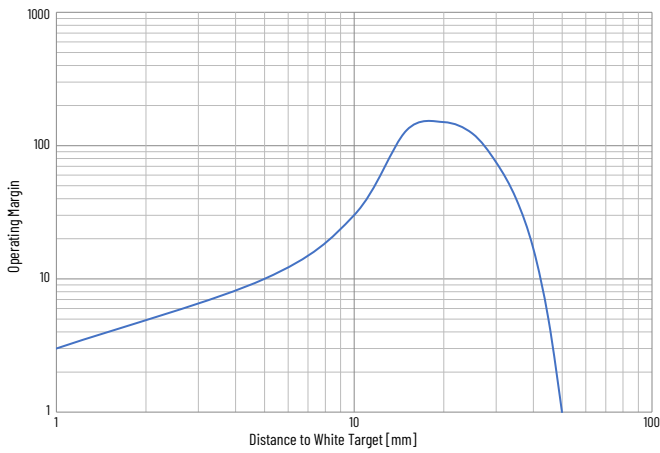

Figure 11 - 100 mm (3.94 in.) Sensing Range - Beam Pattern

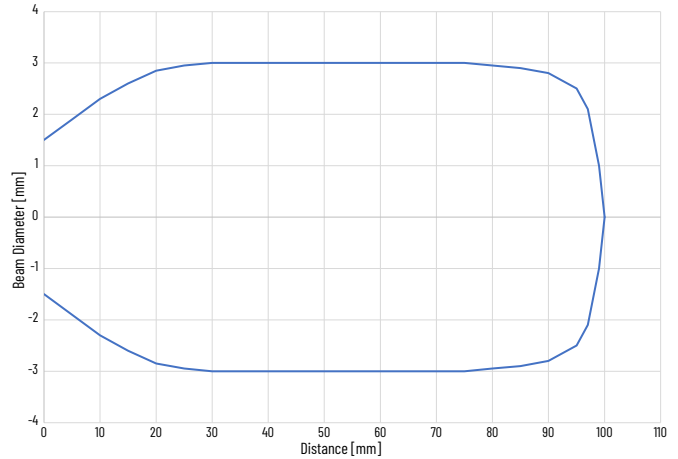

Figure 9 - 50 mm (1.97 in.) Sensing Range - Beam Pattern

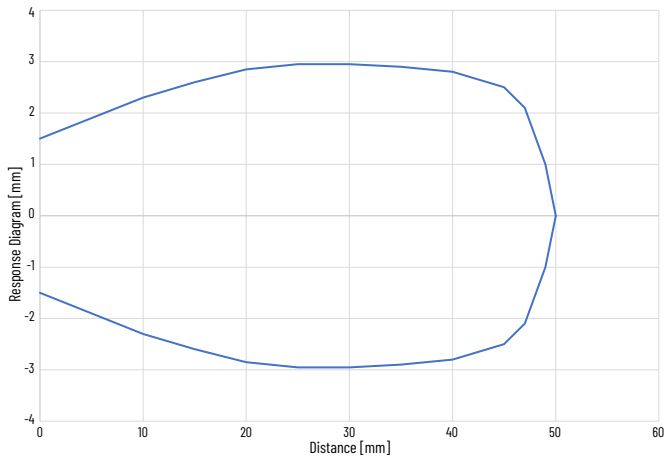

Figure 12 - 250 mm (9.84 in.) Sensing Range - Margin Curves

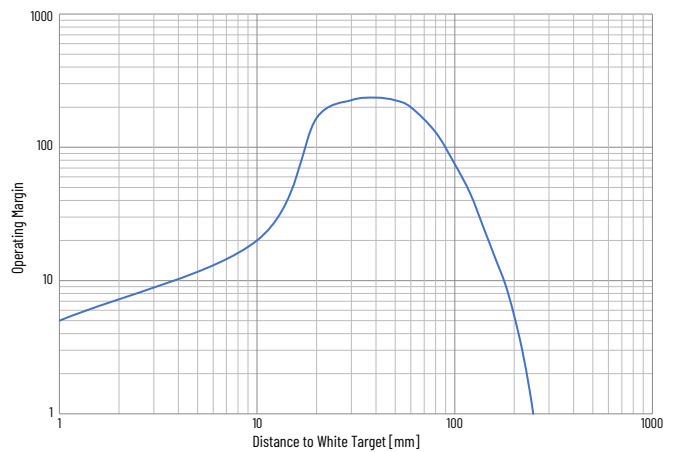

Figure 10 - 100 mm (3.94 in.) Sensing Range - Margin Curves

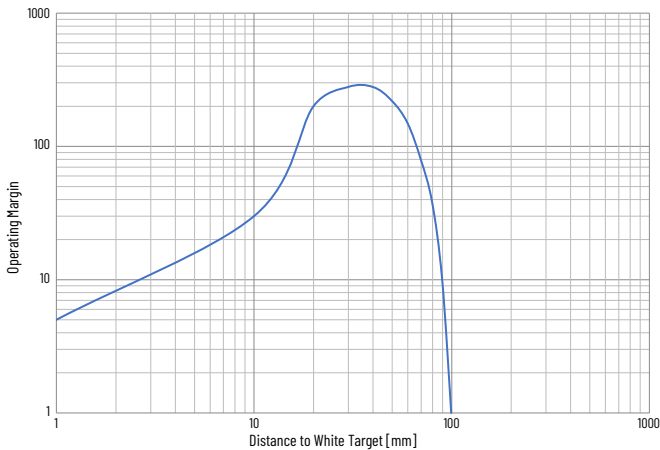
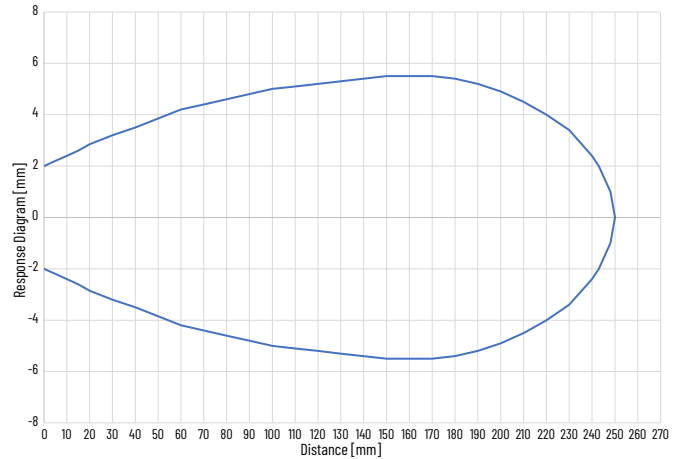

Figure 13 - 250 mm (9.84 in.) Sensing Range - Beam Pattern



Background Reflection

Figure 14 - 250 mm (9.84 in.) Sensing Range - Margin Curves

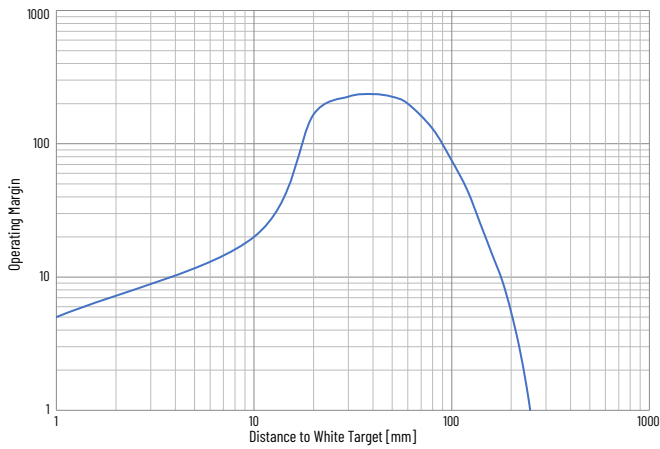
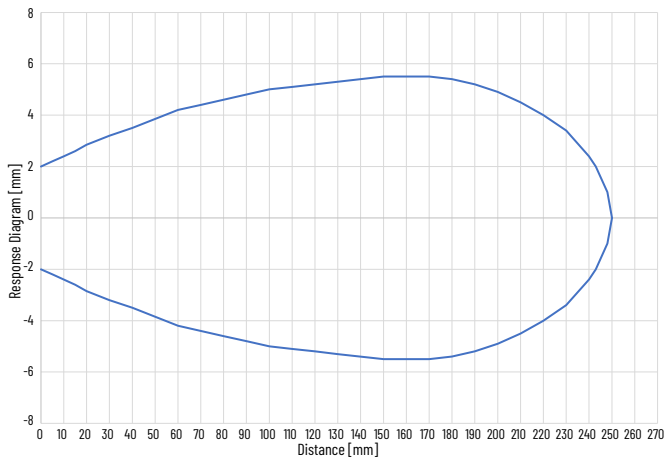
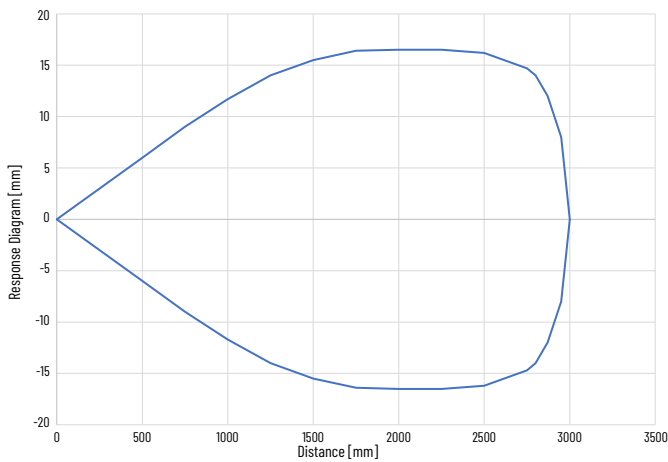

Figure 15 - 250 mm (9.84 in.) Sensing Range - Beam Patterns



Clear Object Detection

Figure 16 - 3 m (9.8 ft) Sensing Range - Beam Patterns



Transmitted Beam

Figure 17 - 25 m (82 ft) Sensing Range - Margin Curves

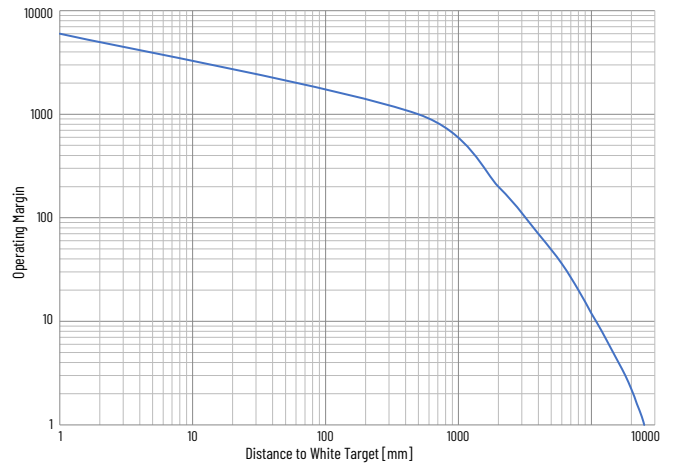
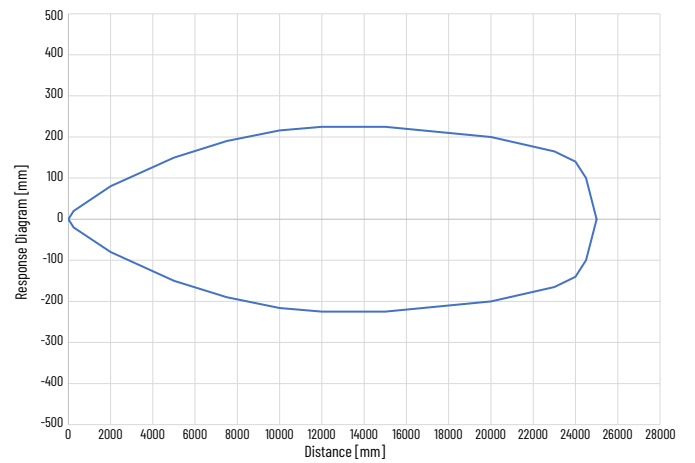

Figure 18 - 25 m (82 ft) Sensing Range - Beam Pattern



Approximate Dimensions

Figure 19 - 2 m (6.6 ft) Cable Models

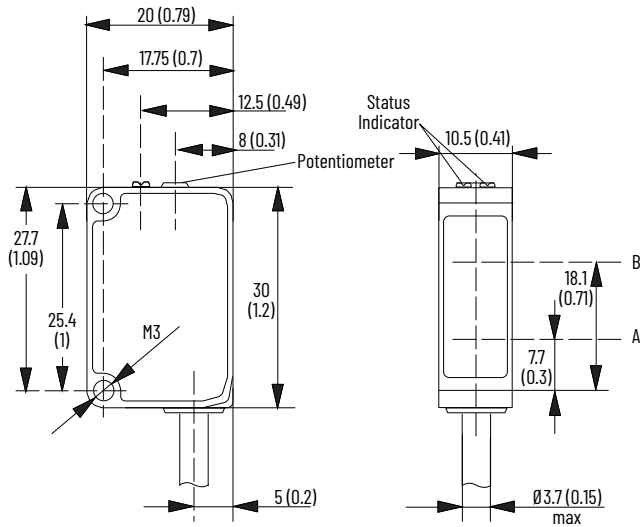
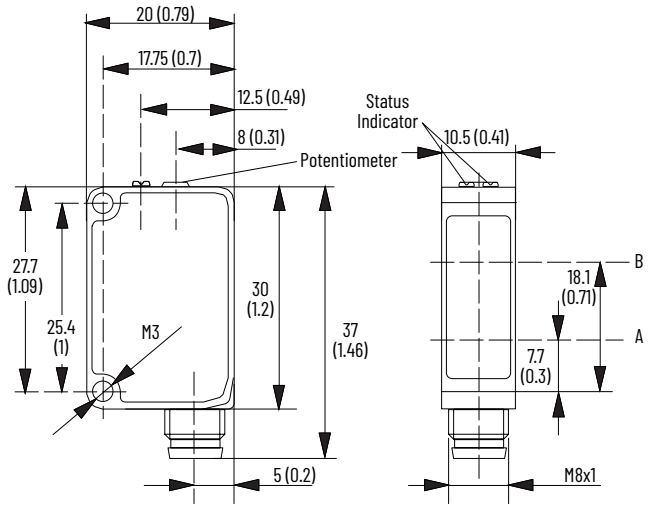

Figure 20 - Integral M8 Pico QD Models



Item	Description
A	Emitter axis
B	Receiver axis

Item	Description
A	Emitter axis
B	Receiver axis

Table 3 - Emitter and Receiver Axis Position

Sensing Mode	A [mm (in.)]	B [mm (in.)]
Diffuse	7.7 (0.3)	18.1 (0.71)
Background suppression	7.7 (0.3)	18.1 (0.71)
Background reflection	7.7 (0.3)	18.1 (0.71)
Polarized retroreflective	7.7 (0.3)	18.1 (0.71)
Clear object detection	7.7 (0.3)	18.1 (0.71)
Transmitted beam emitter		16.3 (0.64)
Transmitted beam receiver		16.3 (0.64)

Accessories

Description		Cat. No.
DC micro (M12) QD cordset, straight, 4-pin, 2 m (6.6 ft)		889D-F4AC-2
DC pico (M8) QD cordset, straight, 4-pin, 2 m (6.6 ft)		889P-F4AB-2
DC pico (M8) QD cordset, right angle, 4-pin, 2 m (6.6 ft)		889P-R4AB-2
Mounting bracket	Stainless steel, L-shaped	60-BJS-L1
		60-BJS-L2
		60-BJT-L2
	Stainless steel, dovetail	60-BKTL-SS
	Plastic, swivel/tilt	60-2619
	Replacement, stainless steel, for replacing larger (50 x 50 mm) sensors	60-BJT-RCS
	Protective, stainless steel, U-shaped	60-BJT-U1
Protective, stainless steel, horizontal and vertical	60-BJT-H1	

Description		Cat. No.
Reflector	Corner cube, 76 mm (3 in.) diameter	92-124
	Corner cube, 84 mm (3.3 in.) diameter	92-125
	Corner cube, 32 mm (1.5 in.) diameter	92-47
	Corner cube, 100 x 100 mm (4 x 4 in.)	92-108
	Corner cube, 51 x 61 mm (2 x 2.5 in.)	92-109
	Micro cube, 51 x 61 mm (2 x 2.5 in.) for laser and clear object models	92-118

Rockwell Automation Support

Use these resources to access support information.

Technical Support Center	Find help with how-to videos, FAQs, chat, user forums, Knowledgebase, and product notification updates.	rok.auto/support
Local Technical Support Phone Numbers	Locate the telephone number for your country.	rok.auto/phonesupport
Technical Documentation Center	Quickly access and download technical specifications, installation instructions, and user manuals.	rok.auto/techdocs
Literature Library	Find installation instructions, manuals, brochures, and technical data publications.	rok.auto/literature
Product Compatibility and Download Center (PCDC)	Download firmware, associated files (such as AOP, EDS, and DTM), and access product release notes.	rok.auto/pcdc

Documentation Feedback





Your comments help us serve your documentation needs better. If you have any suggestions on how to improve our content, complete the form at rok.auto/docfeedback.

Allen-Bradley, expanding human possibility, ProposalWorks, Rockwell Automation, and VisiSight are trademarks of Rockwell Automation, Inc. Trademarks not belonging to Rockwell Automation are property of their respective companies.

Rockwell Automation maintains current product environmental compliance information on its website at rok.auto/pec.

Rockwell Automation NV Commercial Registration Number 0424.293.935

Rockwell Otomasyon Ticaret A.Ş. Kar Plaza İş Merkezi E Blok Kat:6 34752, İçerenköy, İstanbul, Tel: +90 (216) 5698400 EEE Yönetmeliğine Uygundur

Connect with us.    

rockwellautomation.com ————— **expanding human possibility®**

AMERICAS: Rockwell Automation, 1201 South Second Street, Milwaukee, WI 53204-2496 USA, Tel: (1) 414.382.2000

EUROPE/MIDDLE EAST/AFRICA: Rockwell Automation NV, Pegasus Park, De Kleetlaan 12a, 1831 Diegem, Belgium, Tel: (32) 2663 0600

ASIA PACIFIC: Rockwell Automation SEA Pte Ltd, 2 Corporation Road, #04-05, Main Lobby, Corporation Place, Singapore 618494, Tel: (65) 6510 6608

UNITED KINGDOM: Rockwell Automation Ltd., Pitfield, Kiln Farm, Milton Keynes, MK11 3DR, United Kingdom, Tel: (44)(1908) 838-800

Publication 42JB-TD001A-EN-P - January 2025

Copyright © 2025 Rockwell Automation, Inc. All rights reserved. Printed in the U.S.A.