

SoftLogix 5800 Controllers Selection Guide

Catalog Numbers 1789-L10, 1789-L30, 1789-L60

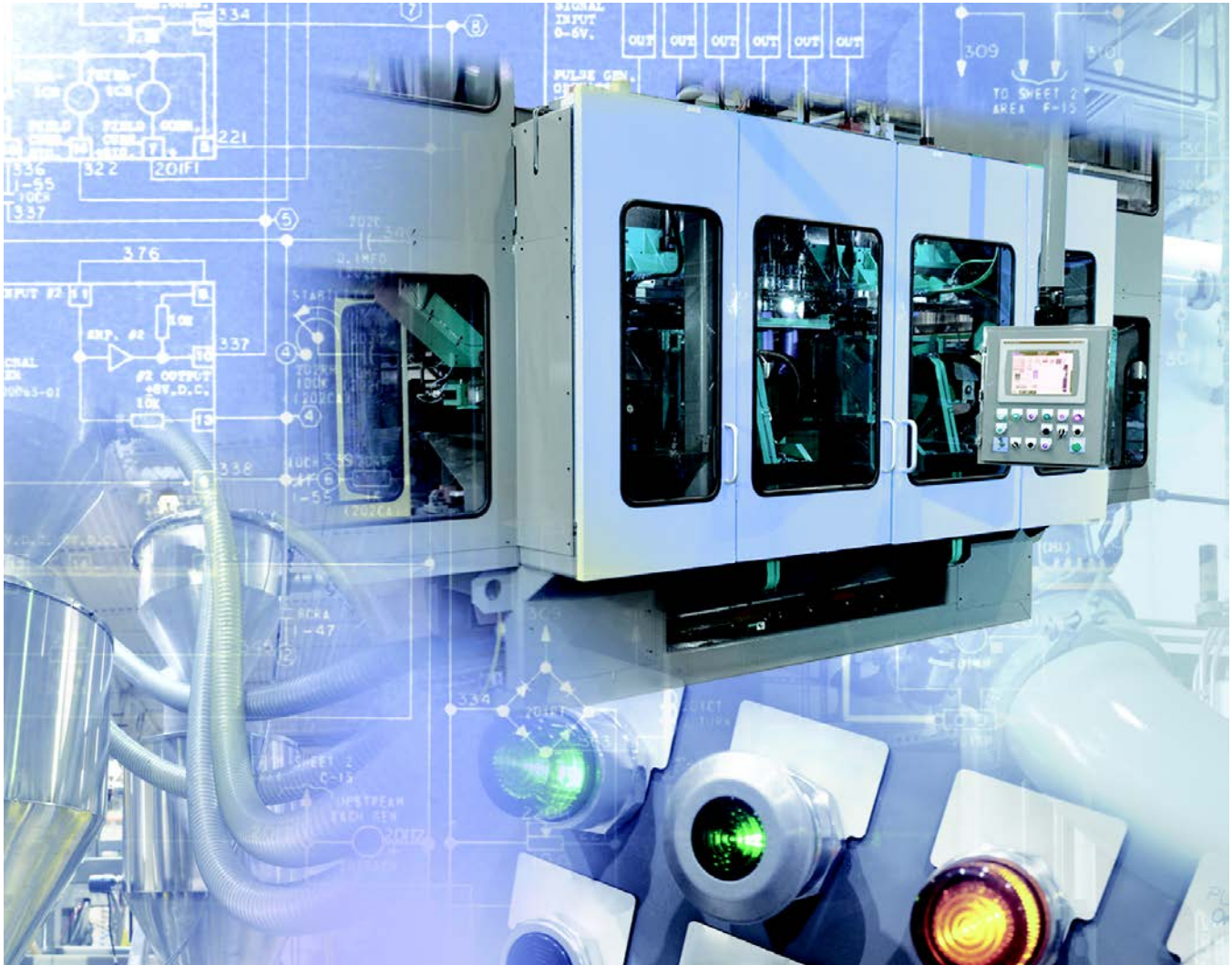

[SoftLogix 5800 System Overview](#)

[SoftLogix 5800 System Layout](#)

[SoftLogix 5800 Controllers](#)

[SoftLogix 5800 Communication Options](#)

[SoftLogix 5800 Programming Software](#)



**LISTEN.
THINK.
SOLVE.®**

Logix Controllers Comparison

Characteristic	ControlLogix® 1756-71, 1756-L72, 1756-L73, 1756-L73XT, 1756-L74, 1756-L75 GuardLogix® 1756-L72S, 1756-L73S, 1756-L73SXT	CompactLogix™ 5370 L3 1769-L30ER, 1769-L30ER-NSE, 1769-L30ERM, 1769-L33ER, 1769-L33ERM, 1769-L36ERM	CompactLogix™ 5370 L2 1769-L24ER-BB1B, 1769-L24ER-QBFC1B, 1769-L27ERM-QBFC1B	CompactLogix™ 5370 L1 1769-L16ER-BB1B, 1769-L18ER-BB1B, 1769-L18ERM-BB1B	CompactLogix™ 1768-L43, 1768-L45 Compact GuardLogix® 1768-L43S, 1768-L45S	SoftLogix™ 5800 1789-L10, 1789-L30, 1789-L60
Controller tasks: • Continuous • Periodic • Event	32; 100 programs/task	32; 100 programs/task	32; 100 programs/task	32; 100 programs/task	• 1768-L43: 16; 32 programs/task • 1768-L45: 30; 32 programs/task	32; 100 programs/task
Event tasks	All event triggers	All event triggers	All event triggers	All event triggers, plus embedded inputs	All event triggers	All event triggers, plus outbound and Windows events
User memory	<ul style="list-style-type: none"> 1756-L71: 2 MB 1756-L72: 4 MB 1756-L72S: 4 MB + 2 MB safety 1756-L73, 1756-L73SXT, 1756-L73XT: 8 MB 1756-L73S: 8 MB + 4 MB safety 1756-L74: 16 MB 1756-L75: 32 MB 	<ul style="list-style-type: none"> 1769-L30ER, 1769-L30ER-NSE, 1769-L30ERM: 1MB 1769-L33ER, 1769-L33ERM: 2 MB 1769-L36ERM: 3 MB 	<ul style="list-style-type: none"> 1769-L24ER: 750 KB 1769-L27ERM: 1 MB 	<ul style="list-style-type: none"> 1769-L16ER: 384 KB 1769-L18ER, 1769-L18ERM: 512 KB 	<ul style="list-style-type: none"> 1768-L43: 2 MB 1768-L43S: 2 MB + 0.5 MB safety 1768-L45: 3 MB 1768-L45S: 3 MB + 1 MB safety 	<ul style="list-style-type: none"> 1789-L10: 2 MB; 1 controller 1789-L30: 64 MB; 3 controllers 1789-L60: 64 MB; 6 controllers
Memory card	Secure Digital	Secure Digital	Secure Digital	Secure Digital	CompactFlash	None
Built-in ports	1 USB	2 EtherNet/IP 1 USB	2 EtherNet/IP 1 USB	2 EtherNet/IP 1 USB	1 RS-232	Depends on personal computer
Communication options	<ul style="list-style-type: none"> EtherNet/IP (standard and safety) ControlNet (standard and safety) DeviceNet (standard and safety) DH+ Remote I/O SynchLink™ 	<ul style="list-style-type: none"> Dual-port EtherNet/IP⁽¹⁾ DeviceNet 	<ul style="list-style-type: none"> Dual-port EtherNet/IP⁽¹⁾ DeviceNet 	<ul style="list-style-type: none"> Dual-port EtherNet/IP⁽¹⁾ 	<ul style="list-style-type: none"> EtherNet/IP (standard and safety) ControlNet (standard and safety) DeviceNet (standard) 	<ul style="list-style-type: none"> EtherNet/IP
Controller connections	500	256	256	256	250	250
Network connections	Per module: <ul style="list-style-type: none"> 128 ControlNet (CN2/B) 40 ControlNet (CNB) 256 EtherNet/IP; 128 TCP (EN2x) 128 EtherNet/IP; 64 TCP (ENBT) 	<ul style="list-style-type: none"> 1769-L30ER, 1769-L30ER-NSE, 1769-L30ERM: 256 EtherNet/IP; 120 TCP 1769-L33ER, 1769-L33ERM: 256 EtherNet/IP; 120 TCP 1769-L36ERM: 256 EtherNet/IP; 120 TCP 	<ul style="list-style-type: none"> 1769-L24ER: 256 EtherNet/IP; 120 TCP 1769-L27ERM: 256 EtherNet/IP; 120 TCP 	<ul style="list-style-type: none"> 1769-L16ER: 256 EtherNet/IP; 120 TCP 1769-L18ER, 1769-L18ERM: 256 EtherNet/IP; 120 TCP 	Per module: <ul style="list-style-type: none"> 48 ControlNet 128 EtherNet/IP; 64 TCP 	Per module: <ul style="list-style-type: none"> 128 EtherNet/IP; 64 TCP
EtherNet/IP nodes in a single Logix Designer application, max	N/A	<ul style="list-style-type: none"> 1769-L30ER, 1769-L30ER-NSE, 1769-L30ERM: 16 1769-L33ER, 1769-L33ERM: 32 1769-L36ERM: 48 	<ul style="list-style-type: none"> 1769-L24ER: 8 1769-L27ERM: 16 	<ul style="list-style-type: none"> 1769-L16ER: 4 1769-L18ER, 1769-L18ERM: 8 	N/A	N/A
Controller redundancy	Full support	Backup via DeviceNet	Backup via DeviceNet	—	Backup via DeviceNet	—
Integrated motion	<ul style="list-style-type: none"> Integrated motion on an EtherNet/IP network SERCOS interface Analog options 	Integrated motion on an EtherNet/IP network	Integrated motion on an EtherNet/IP network	Integrated motion on an EtherNet/IP network	SERCOS interface	N/A
Programming languages	<ul style="list-style-type: none"> Standard task: all languages Safety task: relay ladder, safety application instructions 	<ul style="list-style-type: none"> Relay ladder Structured text Function block SFC 	<ul style="list-style-type: none"> Relay ladder Structured text Function block SFC 	<ul style="list-style-type: none"> Relay ladder Structured text Function block SFC 	<ul style="list-style-type: none"> Standard task: all languages Safety task: relay ladder, safety application instructions 	<ul style="list-style-type: none"> Relay ladder Structured text Function block SFC External routines (C/C++)

(1) CompactLogix 5370 controllers have two EtherNet/IP ports to connect to an EtherNet/IP network. The ports carry the same network traffic as part of the controller's embedded switch. The controller uses only one IP address.

SoftLogix 5800 System Overview

The SoftLogix™ 5800 controller is a soft controller based on the Logix Platform. The Logix platform provides a single integrated control architecture for discrete, drives, motion, process, and safety control. SoftLogix controllers use the Logix control engine and common development tools to provide high performance in an easy-to-use environment. The SoftLogix controller takes the control functions normally found in a dedicated programmable controller, encapsulates them in software, and runs them on a commercial operating system.

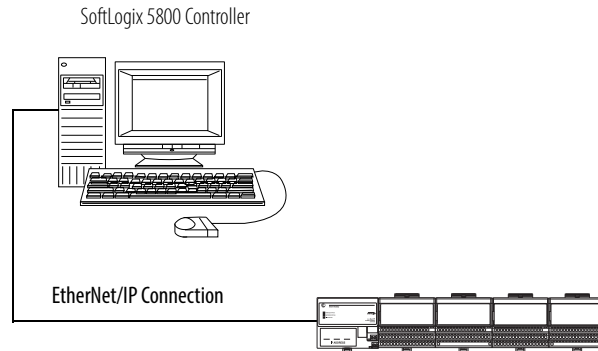

A simple SoftLogix system can consist of a single, standalone computer and its networked devices.

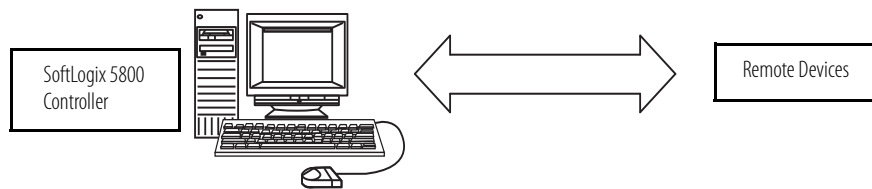

For a more robust system, use I/O in multiple platforms that is distributed in many locations and connected over multiple I/O links.

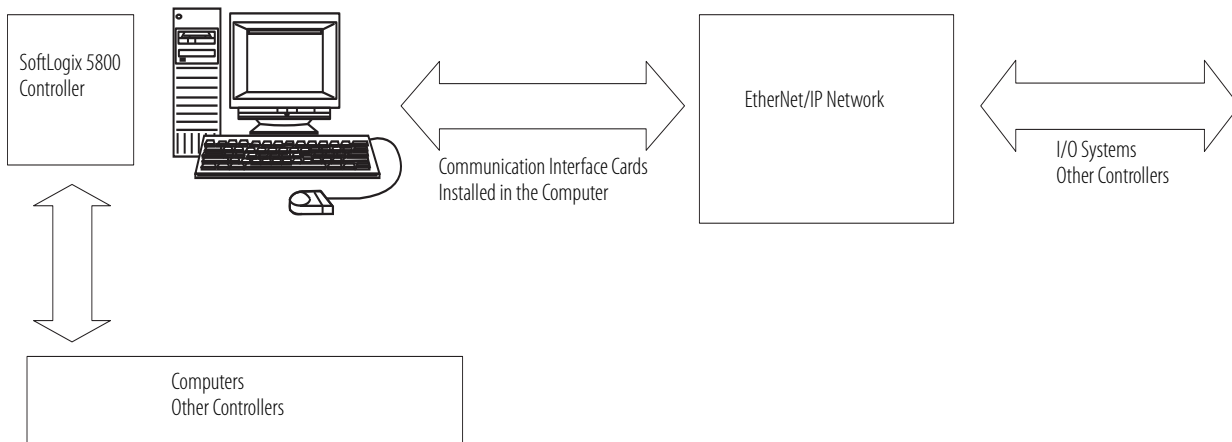

A typical SoftLogix system uses a virtual chassis application, the chassis monitor, that houses controllers and communication modules that interface with other Logix controllers and I/O modules. I/O simulator modules in the virtual chassis make application debugging and system startup easier.

These devices reside on a virtual backplane. The virtual backplane functions like an actual hardware backplane in that it connects the controller and other devices, allows bridging, and supports produced and consumed data. Through the chassis monitor you can create and configure SoftLogix 5800 controllers, create and configure communication cards, and monitor controller status.

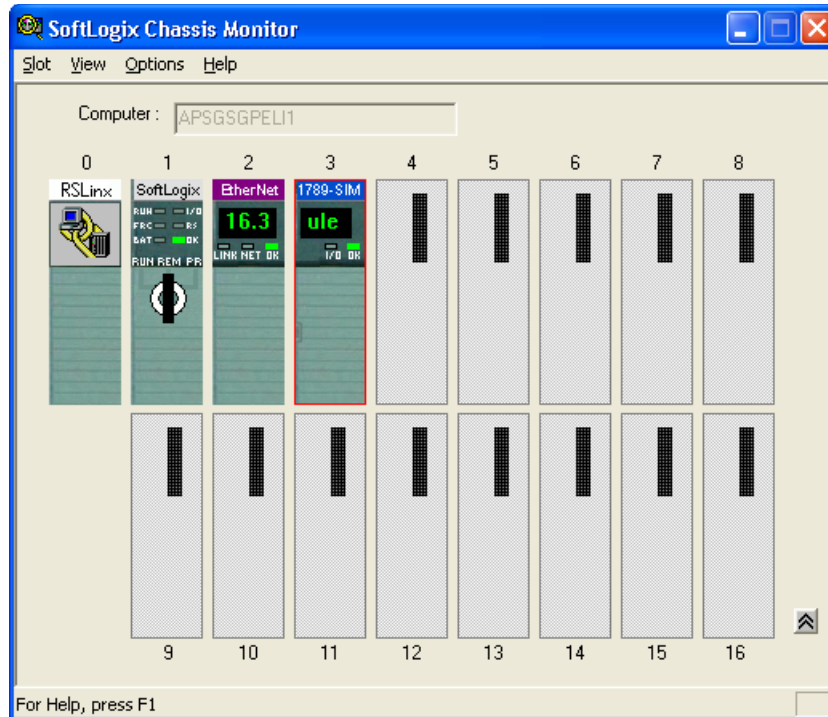

SoftLogix 5800 System Layout

Lay out a SoftLogix 5800 system by determining the network configuration and the placement of components in each location. For a SoftLogix controller to control I/O modules, both the controller and the I/O modules must be directly connected to the same control network.

Place each SoftLogix 5800 controller's I/O on an isolated network to maximize performance and to more easily accommodate future network or system configuration changes. If you plan to share I/O among controllers, make sure the I/O is on a network that each controller can access.

For example, assume that Location A and Location B both require a controller. Each controller's I/O is isolated on its own network. Both controllers must interact with time-critical information. Panel C does not require a controller and can be a communication bridge.

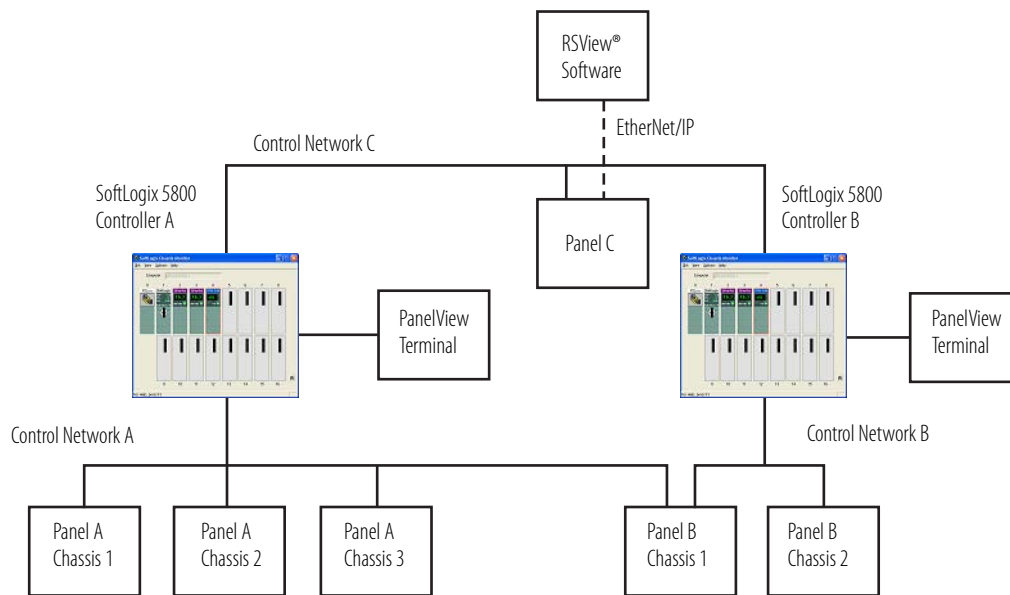

This table lists which controllers in the above example can control which I/O modules. How you configure the I/O modules in the Studio 5000 Logix Designer™ application determines which controller controls which modules.

I/O Location	Controller in Panel A, Chassis 1	Controller in Panel B, Chassis 1
Panel A, Chassis 1	Yes	No
Panel A, Chassis 2	Yes	No
Panel A, Chassis 3	Yes	No
Panel B, Chassis 1	Yes	Yes
Panel B, Chassis 2	No	Yes
Panel C, Chassis 1	Yes	Yes

SoftLogix 5800 Controllers

The SoftLogix 5800 controller supports 32 configurable tasks that can be prioritized. One task can be continuous. The others can be periodic or event-driven tasks. Each task can have as many as 100 programs, each with its own local data and logic, allowing virtual machines to operate independently within the same controller. These SoftLogix controllers are available.

Cat. No.	Capability	Available Slots
1789-L10	1 SoftLogix controller; 2 MB per controller 2 PCI network interface cards ⁽¹⁾ One EtherNet/IP card 1 1784-SIM module No third-party virtual-backplane module support	3-slot virtual chassis
1789-L30	3 SoftLogix controllers; 64 MB per controller 5 PCI network interface cards ⁽²⁾ 5 1784-SIM modules Third-party virtual-backplane module support	5-slot virtual chassis
1789-L60	6 SoftLogix controllers; 64 MB per controller 16 PCI network interface cards ⁽²⁾ 16 1784-SIM modules Third-party virtual-backplane module support	16-slot virtual chassis

(1) Even though the 1789-L10 controller supports two PCI network interface cards, each card must be a different network card. You cannot have two of the same cards installed in the computer.

(2) The number of available slots in the virtual chassis is limited by activation level. You can have as many PCI communication cards as you have available slots in the virtual chassis and in the personal computer.

The same SoftLogix controller is supplied in all of the above products. Regardless of the product you have, select the 1789-L60 controller in the Logix Designer application when you specify a controller.

System Requirements

Important: SoftLogix 5800 controllers and software do not support Integrated Motion on the EtherNet/IP network. ControlNet and DeviceNet are supported in SoftLogix 5800 controller version 20 and earlier. When using a SoftLogix 5800 controller on a Microsoft Windows 7 operating system, the EtherNet/IP network is the only communication network supported; no other communication modules are supported or should be used. Rockwell Automation PCI-based cards are not supported when using the Microsoft Windows 7 operating system.

This table shows system requirements for the SoftLogix 5800 controller.

Category	Description
Personal computer	IBM-compatible Pentium 4, 1.6 GHz or later ⁽¹⁾ Other requirements include the following: <ul style="list-style-type: none"> • FactoryTalk® Activation Manager if you are currently using Factory Activation software. • A hard disk that supports bus mastering. • Bus-mastering drivers for the personal computer's chip set; for Intel motherboards, this software is called Application Accelerator. • Dual CPUs may be required if applications that are resource-intensive are running on the computer, including applications that use sequential, motion, or other local applications running on the computer. • The Studio 5000 Logix Designer application, Version 21.00.00, not required
Operating systems	<ul style="list-style-type: none"> • Microsoft Windows 7 Home Premium Service Pack 1 • Windows 7 Professional Service Pack 1 • Microsoft Windows Server 2008 R2 Standard Edition Service Pack 1 <p>IMPORTANT: When SoftLogix software is installed the following modules will be available in the Chassis Monitor:</p> <ul style="list-style-type: none"> • SoftLogix controller • Soft ENBT • Input/output simulator module <p>IMPORTANT: Motion, ControlNet, and DeviceNet modules are currently not supported in SoftLogix software, version 21.00.</p>
RAM	1 GB, min
Hard disk space	64 MB of free hard disk space per controller instance (or more based on application requirements)
Network requirements	Supports EtherNet/IP and Ethernet port of the personal computer. Third-party networks are supported through the Rockwell Automation® Encompass™ program.
Video requirements	16-color VGA graphics adapter 640 x 480, or later resolution (256-color, 800 x 600 min, for optimal resolution)

(1) The SoftLogix 5800 controller has been tested and qualified only on genuine Intel processors.

External Routines and Applications

You can use external routines and applications to interact with the SoftLogix controller. External routines and applications can do the following:

- Collect data from the controller
- Let events in the controller affect an application
- Let events in an application affect the controller
- Save the current controller information (tag data values and configuration information)

External Routines

Use any programming language that can create a Windows DLL (C and C++) to develop routine objects that invoke functions developed outside of the Studio 5000 environment. After you develop the routine, use the Logix Designer application to add the routine to the controller organizer and use the routine properties to define the DLL to execute. There are three ways to structure an external routine.

Structure	Considerations
Inline	<ul style="list-style-type: none">• Write the code inline.• Keep in mind the controller watchdog timer and make sure the code executes within that time.• Do not perform any screen I/O.• The code executes in real time - it is possible to write code that will interfere with control logic.
Spawn thread	<ul style="list-style-type: none">• Write the code to spawn a thread of execution.• Make sure you only spawn the thread on the first scan.• Slowly executing code in the thread is not bound by the controller watchdog execution time.• Do not perform any screen I/O.• The code executes in real time - it is possible to write code that will interfere with other logic.• Setting the threshold priority to the lowest might prevent interfering with the execution of other logic.• Consider thread and process termination.
Create process	<ul style="list-style-type: none">• Write the code to create another Windows process.• Make sure you only create the process on the first scan.• Use standard Windows interprocess communication techniques.• Slowly executing code in the thread is not bound by the controller watchdog execution time.• You can display user interface elements from the new process.• Set the new process to run at user priority to prevent interfering with the execution of other logic.• Consider thread and process termination.

External Applications

Using standard programming tools, such as Visual Basic, you can develop external applications that do the following.

- Collect data from the controller
- Let events in the controller affect an application
- Let events in an application affect the controller
- Save the current controller information (tag data values and configuration information)

SoftLogix 5800 Communication Options

Available Networks

You can configure your system for information exchange between a range of devices, computing platforms, and operating systems. Select the appropriate communication interface for the network.

Requirements	Network	Communication Interface
<ul style="list-style-type: none">Plant managementMaterial handlingConfiguration, data collection, and control on a single, high-speed networkTime-critical applications with no established scheduleData sent regularlyInternet/Intranet connection	EtherNet/IP network	Windows-compatible Ethernet card
<ul style="list-style-type: none">ModemsSupervisory control and data acquisition (SCADA)	Serial network	Serial port on the computer

Important: ControlNet and DeviceNet are supported in SoftLogix 5800 controllers, version 20 and earlier. SoftLogix 5800 controllers, version 20 and earlier, support the following PCI cards:

- 1784-PCICS card for the ControlNet network (not compatible with Microsoft Windows 7 operating system)
- 1784-PCIDS card for the DeviceNet network (not compatible with Microsoft Windows Vista, Microsoft Windows 2008 Server, and Microsoft Windows 7 operating systems)

EtherNet/IP Network

The Ethernet network Industrial protocol (EtherNet/IP) is an open industrial-networking standard that supports both real-time I/O messaging and message exchange. The EtherNet/IP network uses off-the-shelf Ethernet communication chips and physical media. For access to EtherNet/IP networks, the SoftLogix controller uses your user-supplied Ethernet communication card and RSLinx software.

Capability	Requirements
Remote program upload/download programs	RSLinx Lite software version 2.30.00 or later
Read/write tags	RSLinx single node or later (not the RSLinx Lite that comes with Logix Designer software) RSLinx with OLE for Process Control (OPC) capability (requires RSLinx OEM or later)
Send/receive messages	RSLinx Lite software version 2.30.00 or later
Control I/O	RSLinx Lite software version 2.41.00 or later

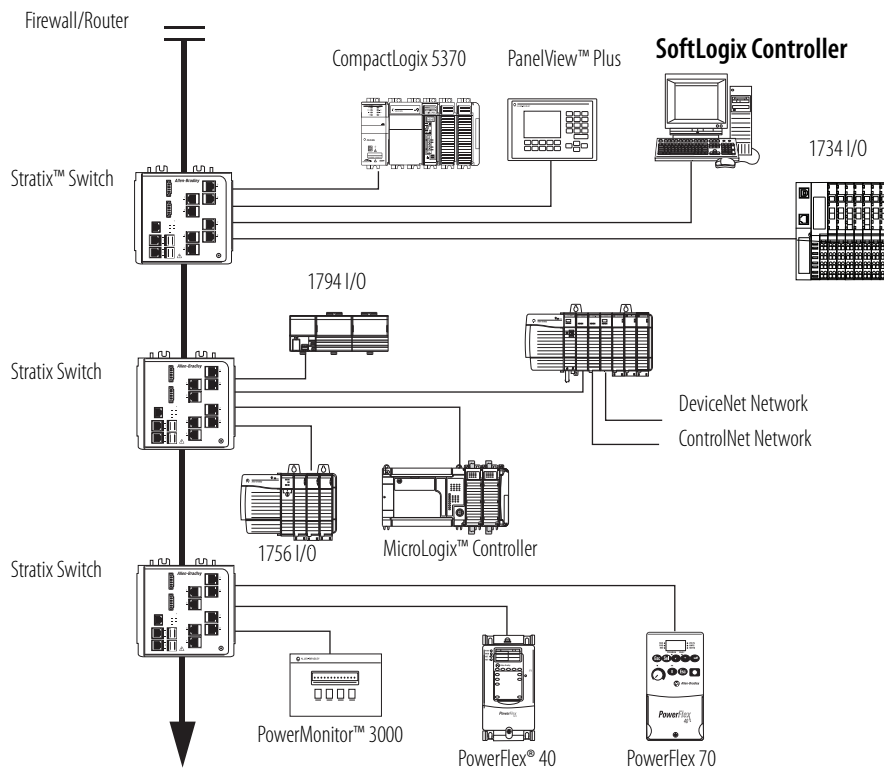

Serial Network

The serial port is compatible with RS-232 serial communication. The serial port supports the DF1 protocol to communicate with other devices on the serial link.

DF1 Mode	Description
Point-to-point	Communication between a controller and other DF1-compatible devices using DF1 full-duplex protocol
DF1 radio modem	SCADA applications where controllers exchange data via radio transmission
DF1 master	Control of polling and message transmission between the master and each slave using DF1 half-duplex polled protocol
DF1 slave	Using the controller as a slave station in a master/slave serial network using DF1 half-duplex protocol
User mode (ASCII)	Communication between a controller and an ASCII device, such as a bar code reader

The fully isolated serial port is Channel 0 and supports DF1, DH-485, and ASCII protocols.

The SoftLogix controller supports one RS-232 serial port per controller. If you have multiple controllers in the virtual chassis, each one can use a serial port.

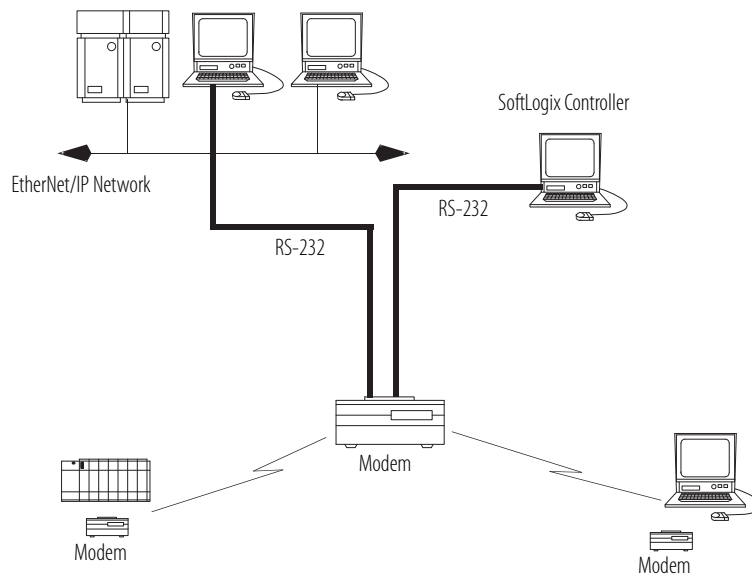

Modbus Support

To access a Modbus RTU network, connect through the serial port and execute a specific ladder-logic routine. For more information, see the Application Solution titled Using Logix5000 Controllers as Masters or Slaves on Modbus, publication [CIG-AP129](#).

SoftLogix 5800 Programming Software

Your selection of modules and network configuration determines what software packages you need to configure and program your system.

Studio 5000 Environment

The Studio 5000 Automation Engineering & Design Environment™ combines engineering and design elements into a common environment. The first element in the Studio 5000® environment is the Logix Designer application. The Logix Designer application is the rebranding of RSLogix™ 5000 software and continues to be the product to program Logix5000™ controllers for discrete, process, batch, motion, safety, and drive-based solutions.

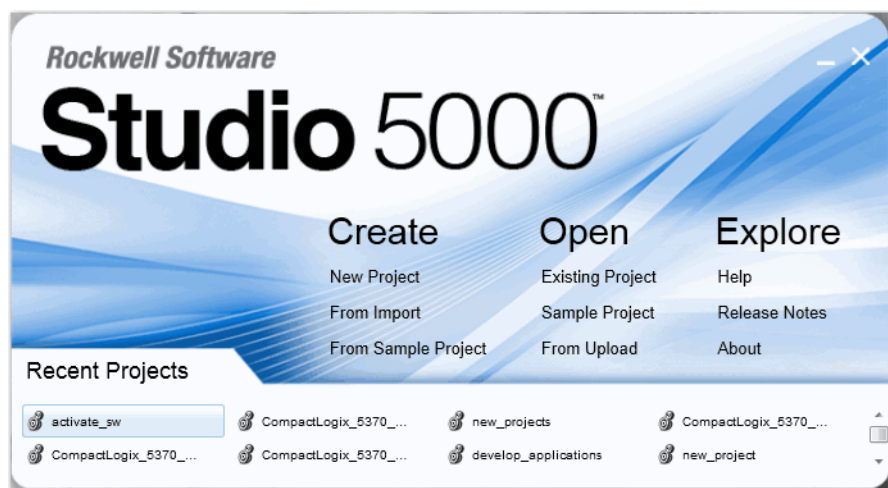

The Studio 5000 environment is the foundation for the future of Rockwell Automation® engineering design tools and capabilities. The Studio 5000 environment is the one place for design engineers to develop all of the elements of their control system.

Hardware Requirements

The personal computer must meet these minimum requirements. By using a computer meeting or exceeding the recommended characteristics, you improve performance.

Characteristic	Minimum	Recommended
Processor	Pentium 4	Intel Core i5
Speed	2.8 GHz	2.4 GHz
RAM memory	1 GB	8 GB
Hard disk space	16 GB free	20 GB free
Graphics device	1024 x 768, true color	DirectX 9, with WDDM 1.0 or higher driver

Software Requirements

Operating system and service pack compatibility is as follows.

- This version of Logix Designer has been tested on the following operating systems.
 - Microsoft Windows 7 Professional (64-bit) with Service Pack 1
 - Microsoft Windows 7 Home Premium (64-bit) with Service Pack 1
 - Microsoft Windows 7 Home Premium (32-bit) with Service Pack 1
 - Microsoft Windows Server 2008 R2 Standard Edition with Service Pack 1
- This version of the Logix Designer application has not been tested but is expected to operate correctly on all other editions and service packs of the following operating systems.
 - Microsoft Windows 7
 - Microsoft Windows Server 2008 R2
- For operating systems that support User Account Control (UAC), this version of the Logix Designer application was tested with UAC set to the most restrictive level (“Always notify” for Windows 7). This version of the Logix Designer application is also expected to operate correctly when UAC is configured for any less restrictive setting.
- Running the Logix Designer application in conjunction with Fast-User Switching, in Safe mode, or via Remote Desktop is not supported.

Additional Software Product Considerations

Additional software compatibility is as follows.

- FactoryTalk Services Platform, version 2.51 or later, is not required to run the Logix Designer application; however, it is required to perform some security functions in the Logix Designer application.
- RSLinx Classic software communication software is not required to install the Logix Designer application; however, it is required to perform online communication with controllers.
- RSLinx Classic, version 3.51.00, is a component aligned to Logix Designer, version 21.00.00. RSLinx Classic software, version 3.51.00, (CPR9 Service Release 5.1) has been tested, and is compatible, with the following products.
 - FactoryTalk Services Platform, version 2.51.00
 - RSLinx Enterprise software, version 5.51.00
 - RSNetWorx™ software, version 21.00.00
 - FactoryTalk Activation Manager, version 3.51.00
- RSLinx Classic software version 3.51.00, Logix Designer application version 21.00.00, and device profiles that ship with the Logix Designer application version 21.00.00 are not compatible with these products.
 - RSNetWorx software, version 11.00.00 or earlier
 - DeviceNet Tag Generator version 11.00.20

RSNetWorx software and the DeviceNet Tag Generator must be upgraded prior to installing these products.

-
- FactoryTalk View SE (CPR 9) software and RSLinx Enterprise communication software are not required to install the Logix Designer application; however, these products are required to fully use the alarm capabilities introduced with version 16.03.00.
 - Be sure to check the software requirements for other Rockwell Software® products that you intend to install to be sure that these products are also compatible with the system.

Notes:

Allen-Bradley, Rockwell Software, Rockwell Automation, LISTEN. THINK. SOLVE, ControlLogix, GuardLogix, CompactGuardLogix, CompactLogix, SoftLogix, MicroLogix, Studio 5000, Studio 5000 Logix Designer, Studio 5000 Automation Engineering & Design Environment, Logix5000, RSLogix, RSNetWorx, PowerMonitor, PanelView, Stratix, Encompass, SynchLink, DH+, FactoryTalk, RSView, and PowerFlex are trademarks of Rockwell Automation, Inc.

Trademarks not belonging to Rockwell Automation are property of their respective companies.

www.rockwellautomation.com

Power, Control and Information Solutions Headquarters

Americas: Rockwell Automation, 1201 South Second Street, Milwaukee, WI 53204-2496 USA, Tel: (1) 414.382.2000, Fax: (1) 414.382.4444

Europe/Middle East/Africa: Rockwell Automation NV, Pegasus Park, De Kleetlaan 12a, 1831 Diegem, Belgium, Tel: (32) 2 663 0600, Fax: (32) 2 663 0640

Asia Pacific: Rockwell Automation, Level 14, Core F, Cyberport 3, 100 Cyberport Road, Hong Kong, Tel: (852) 2887 4788, Fax: (852) 2508 1846