

Rockwell Automation Library of Process Objects: E3/E3 Plus Overload Relay (P_E30vld)

Version 3.5

IMPORTANT

This manual applies to the Rockwell Automation Library of Process Objects version 3.5 or earlier.
For Rockwell Automation Library of Process Objects version 5.0, see

- [PROCES-RM200](#)

For Rockwell Automation Library of Process Objects version 4.0 or later, use the following manuals:

- [PROCES-RM013](#) contains logic instructions
- [PROCES-RM014](#) contains display elements



Important User Information

Read this document and the documents listed in the additional resources section about installation, configuration, and operation of this equipment before you install, configure, operate, or maintain this product. Users are required to familiarize themselves with installation and wiring instructions in addition to requirements of all applicable codes, laws, and standards.

Activities including installation, adjustments, putting into service, use, assembly, disassembly, and maintenance are required to be carried out by suitably trained personnel in accordance with applicable code of practice.

If this equipment is used in a manner not specified by the manufacturer, the protection provided by the equipment may be impaired.

In no event will Rockwell Automation, Inc. be responsible or liable for indirect or consequential damages resulting from the use or application of this equipment.

The examples and diagrams in this manual are included solely for illustrative purposes. Because of the many variables and requirements associated with any particular installation, Rockwell Automation, Inc. cannot assume responsibility or liability for actual use based on the examples and diagrams.

No patent liability is assumed by Rockwell Automation, Inc. with respect to use of information, circuits, equipment, or software described in this manual.

Reproduction of the contents of this manual, in whole or in part, without written permission of Rockwell Automation, Inc., is prohibited.

Throughout this manual, when necessary, we use notes to make you aware of safety considerations.



WARNING: Identifies information about practices or circumstances that can cause an explosion in a hazardous environment, which may lead to personal injury or death, property damage, or economic loss.



ATTENTION: Identifies information about practices or circumstances that can lead to personal injury or death, property damage, or economic loss. Attentions help you identify a hazard, avoid a hazard, and recognize the consequence.

IMPORTANT

Identifies information that is critical for successful application and understanding of the product.

Labels may also be on or inside the equipment to provide specific precautions.



SHOCK HAZARD: Labels may be on or inside the equipment, for example, a drive or motor, to alert people that dangerous voltage may be present.



BURN HAZARD: Labels may be on or inside the equipment, for example, a drive or motor, to alert people that surfaces may reach dangerous temperatures.



ARC FLASH HAZARD: Labels may be on or inside the equipment, for example, a motor control center, to alert people to potential Arc Flash. Arc Flash will cause severe injury or death. Wear proper Personal Protective Equipment (PPE). Follow ALL Regulatory requirements for safe work practices and for Personal Protective Equipment (PPE).

Preface	Software Compatibility and Content Revision	5
	Additional Resources	5
E3/E3 Plus Overload Relay (P_E30vId)	Guidelines	8
	Functional Description	8
	Required Overload Configuration	9
	Required Files	9
	Controller File	9
	Visualization Files	9
	Controller Code	11
	E3/E3 Plus Overload Relay InOut Structure	11
	E3/E3 Plus Overload Relay Input Structure	11
	E3/E3 Plus Overload Relay Output Structure	14
	E3/E3 Plus Overload Relay Local Configuration Tags	17
	Operations	18
	Modes	18
	Alarms	19
	Simulation	19
	Execution	19
	Programming Example	20
	Display Elements	21
	Status/Quality Indicators	22
	Alarm Indicators	23
	Faceplate	26
	Operator Tab	27
	Maintenance Tab	30
	Engineering Tab	32
	Diagnostics Tab	35
	Alarms Tab	36
	E3/E3 Plus Overload Relay Faceplate Help	38

Notes:

Software Compatibility and Content Revision

Table 1 - Summary of Changes

Topic	Page
Visualization Files: Global Objects (.ggfx) - Process Diagnostic Objects	10

For the latest compatible software information and to download the Rockwell Automation® Library, see the Product Compatibility and Download Center at <http://www.rockwellautomation.com/rockwellautomation/support/pcdc.page>.

For general library considerations, see rockwell Automation Library of Process Objects, publication [PROCES-RM002](#).

Additional Resources

These documents contain additional information concerning related products from Rockwell Automation.

Resource	Description
PlantPax® Distributed Control System Selection Guide, publication PROCES-SG001	Provides information to assist with equipment procurement for your PlantPax system.
PlantPax Distributed Control System Reference Manual, publication PROCES-RM001	Provides characterized recommendations for implementing your PlantPax system.
Rockwell Automation Library of Process Objects, publication PROCES-RM002	Provides general considerations for the PlantPax system library of process objects.
FactoryTalk® View Machine Edition User Manual, publication VIEWME-UM004	Provides details on how to use this software package for creating an automation application.
FactoryTalk View Site Edition User Manual, publication VIEWSE-UM006	Provides details on how to use this software package for developing and running human-machine interface (HMI) applications.
Logix5000™ Controllers Add-On Instructions Programming Manual, publication 1756-PM010	Provides information for designing, configuring, and programming Add-On Instructions.
Rockwell Automation Library of Process Objects: Common Alarm Block (P_Alarm) Reference Manual, publication SYSLIB-RM002	Details how to monitor an input condition to raise an alarm.
Rockwell Automation Library of Process Objects: E1 Plus™ overload relay(P_E1PlusE) Reference Manual, publication SYSLIB-RM049A-EN-P	Details how to control and monitor a 193-ETN (E1 Plus on EtherNet/IP) overload relay.
Rockwell Automation Library of Process Objects: E300™ overload relay(EtherNet/IP) (P_E300vld) Reference Manual, publication SYSLIB-RM051A-EN-P	Details how to controls and monitors a 193-ECM-ETR (E300 on EtherNet/IP) overload relay.

Notes:

E3/E3 Plus Overload Relay (P_E3Ovld)

The P_E3Ovld (E3™/E3 Plus™ overload relay) Add-On Instruction controls and monitors a 193/592-EC1, -EC2, -EC3, or -EC5 overload relay.

The image displays the configuration and faceplate for the P_E3Ovld Add-On Instruction. It is divided into three main sections:

- Add-On Instruction:** A tree view showing the object hierarchy for P_E3Ovld (E3 / E3Plus Overload Relay). The tree includes:
 - Inp
 - Inp_Trip
 - Inp_TripReset
 - Out
 - Val_TripResTimeMin
 - Val_TripResTimeSec
 - Sts_WarnBits
 - Sts_TripBits
 - Sts_Inp1
 - Sts_Inp2
 - Sts_Inp3
 - Sts_Inp4
 - Sts_OutA
 - Sts_OutB
 - Sts_LocalResetReqd
 - Sts_Err
 - Sts_Warn
 - Sts_Trip
- Global Object:** A small icon representing a motor or relay.
- Faceplate:** A graphical user interface for the P_E3Ovld - Motor Overload Relay. It features:
 - Home - Operator status bar.
 - Average % Full Load Amps: 88.0.
 - An OK button and a red square indicator.
 - Inputs:** Run Feedback and Disconnect Closed (both with radio buttons).
 - Outputs:** Starter Energized (with a radio button).
 - A Comm Good status bar at the bottom.

Guidelines

Use this instruction to monitor an Allen-Bradley® E3 or E3 Plus motor overload relay using its built-in DeviceNet interface or using a 2100-ENET EtherNet/IP interface. This instruction monitors the overload relay for warning and trip conditions, displays motor current as a percentage of Full Load Amps (% FLA), and provides commands to initiate a remote trip and a remote trip reset. The instruction provides alarms for trip warning, relay trip, and I/O communication failure.

Do not use this instruction if you have other Allen-Bradley motor overload relays, such as the E1 Plus, E300, or 857 series:

- For the E1 Plus series of motor overload relays using the 193-ETN EtherNet/IP interface, use the P_E1PlusE Add-On Instruction instead.
- For the E300 series of motor overload relays, use the P_E300Ovld Add-On Instruction.
- Other overload relays can be monitored by specific logic or are supported by future Add-On Instructions.

Functional Description

The E3/E3 Plus overload relay instruction provides the following capabilities:

- Warning of impending overloads
- Identification of overload trip conditions
- Countdown of time until overload trip can be reset
- Configurable command to initiate a remote test trip
- Configurable command to initiate a trip reset

TIP Three trips within a configurable time requires resetting the trip locally (at the relay).

- Monitoring of states of relay's discrete inputs and discrete outputs
- Monitors input quality and communication status and provides value and indication of source and quality for the input
- Alarms for Trip Warning, Overload Trip, and I/O Fault
- Supports HMI 'breadcrumbs' for Alarm Inhibited, Bad Configuration, Not Ready

Required Overload Configuration

Be sure that you set up the E3/E3 Plus parameters as follows:

- Input Assembly
 - Device Status Word (parameter 21) - set parameter 61 to 21
 - Warning Status (parameter 15) - set parameter 62 to 15
 - Trip Status (parameter 14) - set parameter 63 to 14
 - Average Percent Full Load Amps (parameter 8) - set parameter 64 to 8
- Output Assembly

The P_E3Ovld Add-On Instruction uses only the Remote Trip and Remote Trip Reset bits in the Output assembly.

Required Files

Add-On Instructions are reusable code objects that contain encapsulated logic that can streamline implementing your system. This lets you create your own instruction set for programming logic as a supplement to the instruction set provided natively in the ControlLogix® firmware. An Add-On Instruction is defined once in each controller project, and can be instantiated multiple times in your application code as needed.

Controller File

The P_E3Ovld_3_5-00_AOIL5X Add-On Instruction must be imported into the controller project to be used in the controller configuration. The service release number (boldfaced) can change as service revisions are created.

Visualization Files

This Add-On Instruction has associated visualization files that provide a common user interface. These files can be downloaded from the Product Compatibility and Download Center at <http://www.rockwellautomation.com/rockwellautomation/support/pcdc.page>.

IMPORTANT	The visualization file dependencies require Process Library content imports to occur in a specific order as reflected in the following tables: <ul style="list-style-type: none">• Images• Global Objects• Standard Displays• HMI Tags• Macros
------------------	--

Images are external graphic files that can be used in displays. They must be imported for FactoryTalk View to make use of them.

When PNG files are imported, they are renamed by FactoryTalk View with a .bmp file extension, but retain a .png format.

Table 2 - Visualization Files: Images (.png)

FactoryTalk View SE Software	FactoryTalk View ME Software	Description
All .png files in the images folder	All .png files in the images folder	These are the common icons used in the global objects and standard displays for all Process Objects.

The Global Object files (.ggfx file type) in the following table are Process Library display elements that are created once and referenced multiple times on multiple displays in an application. When changes are made to a Global Object, all instances in the application are automatically updated.

Table 3 - Visualization Files: Global Objects (.ggfx)

FactoryTalk View SE Software	FactoryTalk View ME Software	Description
(RA-BAS) Common Faceplate Objects	(RA-BAS-ME) Common Faceplate Objects	Global objects used on process object faceplates.
(RA-BAS) Process Alarm Objects	(RA-BAS-ME) Process Alarm Objects	Global objects used for managing alarms on process object faceplates.
(RA-BAS) Process Diagnostic Objects	(RA-BAS-ME) Process Diagnostic Objects	Diagnostic global objects used on process object faceplates.
(RA-BAS) Process Faceplate Motor Objects	(RA-BAS-ME) Process Faceplate Motor Objects	Motor global objects used on process object faceplates.
(RA-BAS) Process Graphics Library	(RA-BAS-ME) Process Graphics Library	Process global object device symbols used to build process graphics
(RA-BAS) Process Help Objects	(RA-BAS-ME) Process Help Objects	Global objects used for all process objects help displays.

The Standard Display files (.gfx file type) in the following table are the Process Library displays that you see at runtime.

Table 4 - Visualization Files: Standard Displays (.gfx)

FactoryTalk View SE Software	FactoryTalk View ME Software	Description
(RA-BAS) Common-AnalogEdit	N/A	Faceplate used for analog input data entry. The FactoryTalk View ME faceplates use the native analog input data entry so no file is required.
(RA-BAS) P_Alarm-Faceplate	(RA-BAS-ME) P_Alarm-Faceplate	The faceplate that is used for managing alarms for the object.
(RA-BAS) P_Alarm-Help	(RA-BAS-ME) P_Alarm-Help	Alarm Help information that is accessed from the P_Alarm faceplate.
(RA-BAS) P_E3Ovld-Faceplate	(RA-BAS-ME) P_E3Ovld-Faceplate	The faceplate that is used for the object
(RA-BAS) Process Ovld Family-Help	(RA-BAS-ME) Process Ovld Family-Help	The Help display for Overload objects

HMI Tags are created in a FactoryTalk View ME application to support tab switching on Process Library faceplates. The HMI tags may be imported via the comma-separated values file (.csv file type) in the following table.

Table 5 - Visualization Files: HMI Tags (.csv)

FactoryTalk View SE Software	FactoryTalk View ME Software	Description
N/A	FTVME_PlantPaxLib_Tags_3_5_XX.csv where XX = the service release number.	These tags must be imported into the FactoryTalk View ME project to support switching tabs on any Process Object faceplate.

Controller Code

This section describes the parameter references for this Add-On Instruction.

E3/E3 Plus Overload Relay InOut Structure

InOut parameters are used to link the Add-On Instruction to external tags that contain necessary data for the instruction to operate. These external tags must be of the data type shown.

Tag Name	Data Type	Description
Inp	P_E3Ovld_Inp	E3 Overload Parameter-based Input Assembly (100)

E3/E3 Plus Overload Relay Input Structure

Input parameters include the following:

- Input data elements (Inp_) are typically used to connect field inputs from I/O modules or signals from other objects.
- Configuration data elements (Cfg_) are used to set configurable capabilities and features of the instruction.
- Commands (PCmd_, OCmd_, MCmd_) are used by program logic, operators, and maintenance personnel to request instruction actions.

Table 7 - P_E3Ovld Input Parameters

Input Parameter	Data Type	Alias For	Default	Description
EnableIn	BOOL		1	<p>Ladder Diagram: If the rung-in condition is true, the instruction's Logic routine executes. If the rung-in condition is false, the instruction's EnableInFalse routine executes.</p> <p>Function Block Diagram: If true, or not connected, the instruction's Logic routine executes. If the parameter is exposed as a pin and wired, and the pin is false, the instruction's EnableInFalse routine executes.</p> <p>Structured Text: No effect. The instruction's Logic routine executes.</p>
Inp_Trip	BOOL		0	1 = Send Remote Trip request to Overload Relay.
Inp_TripReset	BOOL		0	1 = Send Trip Reset request to Overload Relay.
Inp_Reset	BOOL		0	1 = Reset All Latched Alarms.
Cfg_E3Plus	BOOL		0	0 = E3 (2 discrete inputs and 1 discrete output) 1 = E3 (4 discrete inputs and 2 discrete outputs).
Cfg_AllowOperTrip	BOOL		0	1 = Remote Trip or Trip Reset function is available to Operator.
Cfg_AllowOperReset				
Cfg_AllowMaintTrip	BOOL		0	1 = Remote Trip or Trip Reset function is available to Maintenance.
Cfg_AllowMaintReset				

Table 7 - P_E30vld Input Parameters

Input Parameter	Data Type	Alias For	Default	Description
Cfg_PCcmdClear	BOOL		1	When this parameter is 1, program commands are cleared once they are acted upon. When set to 0, program commands remain set until cleared by the application program logic. IMPORTANT: Clearing this parameter online can cause unintended program command execution.
Cfg_HasWarnAlm	BOOL	Warn.Cfg_Exists	0	These parameters determine whether the corresponding alarm exists and is checked or if the alarm does not exist and is not used. When these parameters are 1, the corresponding alarm exists.
Cfg_HasTripAlm		Trip.Cfg_Exists	1	
Cfg_HasIOFaultAlm		IOFault.Cfg_Exists	0	
Cfg_WarnResetReqd	BOOL	Warn.Cfg_ResetReqd	0	These parameters determine whether a reset is required to clear the alarm status. When these parameters are 1, the alarm is latched ON when the alarm occurs. After the alarm condition returns to normal, a reset is required to clear the alarm status (for example, OCmd_Reset, Inp_Reset, or Trip.OCmd_Reset are required to clear Alm_Trip alarm after the alarm is set and the value returns to normal). When this parameter is 0, no reset is required and the alarm status is cleared when the alarm condition returns to normal. IMPORTANT: If the reset clears the alarm, it also acknowledges the alarm.
Cfg_TripResetReqd		Trip.Cfg_ResetReqd		
Cfg_IOFaultResetReqd		IOFault.Cfg_ResetReqd		
Cfg_WarnAckReqd	BOOL	Warn.Cfg_AckReqd	1	These parameters determine whether an acknowledgement is required for an alarm. When these parameters are 1, the acknowledge (ack) bit is cleared when the alarm occurs. An acknowledge command (for example, PCmd_TripAck or Trip.OCmd_Ack) is required to acknowledge the alarm. When set to 0, the Acknowledge bit is set when an alarm occurs indicating an acknowledged alarm and no acknowledge command is required.
Cfg_TripAckReqd		Trip.Cfg_AckReqd		
Cfg_IOFaultAckReqd		IOFault.Cfg_AckReqd	0	
Cfg_WarnSeverity	INT	Warn.Cfg_Severity	500	These parameters determine the severity of each alarm. This drives the color and symbol that are used to indicate alarm status on the faceplate and global object. The following are valid values: 1...250 = Low 251...500 = Medium 501...750 = High 751...1000 = Urgent IMPORTANT: For FactoryTalk View software version 7.0, these severity parameters drive only the indication on the global object and faceplate. The Alarms and Events definition of severity drives the color and symbol that is used on the alarm banner and alarm summary as well as the value returned by factoryTalk Alarms and Events display commands.
Cfg_TripSeverity		Trip.Cfg_Severity	750	
Cfg_IOFaultSeverity		IOFault.Cfg_Severity	1000	
Cfg_PulseT	DINT		5	Time (seconds) to pulse Trip Reset or Remote Trip output to E3.
Cfg_LocalResetReqdT	DINT		3600	No more than (1, 2, 3) remote Trip Resets are allowed in this amount of time (seconds).
Cfg_LocalResetReqdNum	DINT		3	No more than this many remote Trip Resets are allowed in (configured) time.
PCmd_Trip	BOOL		0	When Cfg_PCcmdClear is 1: <ul style="list-style-type: none"> Set PCmd_Trip to 1 to send remote trip request to Overload Relay Set PCmd_TripReset to 1 to send trip reset request to Overload Relay These parameters reset automatically When Cfg_PCcmdClear is 0: <ul style="list-style-type: none"> Set PCmd_Trip to 1 to send remote trip request to Overload Relay Set PCmd_TripReset to 1 to send trip reset request to Overload Relay These parameters do not reset automatically
PCmd_TripReset				
PCmd_Reset	BOOL		0	<ul style="list-style-type: none"> Set PCmd_Reset to 1 to reset all alarms requiring reset This parameter is always reset automatically
PCmd_WarnAck	BOOL	Warn.PCmd_Ack	0	<ul style="list-style-type: none"> Set PCmd_<Alarm>Ack to 1 to Acknowledge alarm The parameter is reset automatically
PCmd_TripAck		Trip.PCmd_Ack		
PCmd_IOFaultAck		IOFault.PCmd_Ack		

Table 7 - P_E3Ovld Input Parameters

Input Parameter	Data Type	Alias For	Default	Description
PCmd_WarnSuppress	BOOL	Warn.PCmd_Suppress	0	When Cfg_PCmdClear is 1: <ul style="list-style-type: none"> Set PCmd_<Alarm>Suppress to 1 to suppress alarm Set PCmd_<Alarm>Unsuppress to 1 to unsuppress alarm These parameters reset automatically When Cfg_PCmdClear is 0: <ul style="list-style-type: none"> Set PCmd_<Alarm>Suppress to 1 to suppress alarm Set PCmd_<Alarm>Suppress to 0 to unsuppress alarm PCmd_<Alarm>Unsuppress is not used These Parameters do not reset automatically
PCmd_TripSuppress		Trip.PCmd_Suppress		
PCmd_IOFaultSuppress		IOFault.PCmd_Suppress		
PCmd_WarnUnsuppress	BOOL	Warn.PCmd_Unsuppress	0	
PCmd_TripUnsuppress		Trip.PCmd_Unsuppress	0	
PCmd_IOFaultUnsuppress		IOFault.PCmd_Unsuppress	0.00E+00	
PCmd_WarnUnshelve	BOOL	Warn.PCmd_Unshelve	0	<ul style="list-style-type: none"> Set PCmd_<Alarm>Unshelve to 1 to Unshelve alarm The parameter is reset automatically
PCmd_TripUnshelve		Trip.PCmd_Unshelve	0	
PCmd_IOFaultUnshelve		IOFault.PCmd_Unshelve	0.00E+00	
OCmd_Trip	BOOL		0	Operator command to send remote trip request to overload relay.
OCmd_TripReset	BOOL		0	Operator command to send trip request to overload relay.
OCmd_Reset	BOOL		0	Operator command to reset all alarms requiring reset.
OCmd_ResetAckAll	BOOL		0	Operator command to reset all alarms and latched shed conditions.

E3/E3 Plus Overload Relay Output Structure

Output parameters include the following:

- Output data elements (Out_) are the primary outputs of the instruction, typically used by hardware output modules; however, they can be used by other application logic.
- Value data elements (Val_) are numeric outputs of the instruction for use by the HMI. Values can also be used by other application logic or software packages.
- Source and Quality data elements (SrcQ_) are outputs of the instruction used by the HMI to indicate PV source and quality.
- Status data elements (Sts_) are bit outputs of the instruction for use by the HMI. Status bits can also be used by other application logic.
- Error data elements (Err_) are outputs of the instruction that indicate a particular configuration error. If any Err_ bit is set then the Sts_Err configuration error summary status is set and the Invalid Configuration indicator is displayed on the HMI.
- Not Ready data elements (Nrdy_) are bit outputs of the instruction for use by the HMI for displaying the Device Not Ready indicator. Status bits can also be used by other application logic.
- Alarm data elements (Alm_) are outputs of the instruction that indicate a particular alarm has occurred.
- Acknowledge data elements (Ack_) are outputs of the instruction that indicate the corresponding alarm has been acknowledged.
- Ready data elements (Rdy_) are bit outputs of the instruction used by the HMI to enable or disable Command buttons and Setting entry fields.

Table 8 - P_E30vld Output Parameters

Output Parameters	Data Type	Alias For	Description
EnableOut	BOOL		Enable Output: The EnableOut signal is not manipulated by this instruction. Its output state always reflects EnableIn Input state.
Out_ResetTrip	BOOL		1 = Reset overload trip.
Out_UserTrip	BOOL		1 = Initiate User trip.
Val_AvgPctFLA	REAL		Average of phase currents expressed as a percentage of full load amperes (%FLA).

Table 8 - P_E3Ovid Output Parameters

Output Parameters	Data Type	Alias For	Description
SrcQ_IO	SINT		I/O signal source and quality.
SrcQ			Final source and quality: GOOD 0 = I/O live and confirmed good quality 1 = I/O live and assumed good quality 2 = No feedback configured, assumed good quality TEST 8 = Device simulated 9 = Device loopback simulation 10 = Manually entered value UNCERTAIN 16 = Live input, off-specification 17 = Value substituted at device/bus 18 = Value substituted by maintenance (Has and not Use) 19 = Shed, using last good value 20 = Shed, using replacement value BAD 32 = Signal failure (out-of-range, NaN, invalid combination) 33 = I/O channel fault 34 = I/O module fault 35 = Bad I/O configuration (for example, scaling parameters)
Val_Fault	SINT		Device Fault Status: 0 = None 15 = Warning 30 = Tripped 31 = Local Reset required 32 = I/O Fault 34 = Config Error
Val_Notify	SINT		Current alarm level and acknowledgement (enumeration): 0 = No alarm 1 = Alarm cleared: a reset or acknowledge is required 2 = Low (acknowledged) 3 = Low (unacknowledged) 4 = Medium (acknowledged) 5 = Medium (unacknowledged) 6 = High (acknowledged) 7 = High (unacknowledged) 8 = Urgent (acknowledged) 9 = Urgent (unacknowledged)
Sts_WarnBits	INT		Warning Reason Bits from Overload Relay.
Sts_TripBits	INT		Trip Reason Bits from Overload Relay.
Sts_Inp1	BOOL		Status of discrete input #1, #2, #3 (E3 Plus only), and #4 (E3 Plus only).
Sts_Inp2			
Sts_Inp3			
Sts_Inp4			
Sts_OutA	BOOL		Status of discrete output A and discrete output B (E3 Plus only).
Sts_OutB			
Sts_LocalResetReqd	BOOL		Too many remote resets: go to starter, find cause, and reset there.
Sts_NotRdy	BOOL		1 = Device Not Ready, see detail bits for reason.
Nrdy_Trip	BOOL		1 = Device Not Ready: • Tripped (at device or by command). • I/O Fault (shed requires reset).
Nrdy_IOFault	BOOL		
Sts_Almlnh	BOOL		1 = An alarm is Shelved, Disabled, or Suppressed: display icon.
Sts_Err	BOOL		1 = Error in configuration: see detail bits for reason.

Table 8 - P_E30vId Output Parameters

Output Parameters	Data Type	Alias For	Description
Err_Timer	BOOL		1 = Error in configuration: Reset pulse timer preset (use 0...2,147,483).
Err_Alarm	BOOL		1 = Error in configuration: Alarm Min On Time or Severity.
Sts_Warn	BOOL	Warn.Inp	Warning of impending trip (see Sts_WarnBits for reason).
Sts_Trip		Trip.Inp	Overload Tripped (see Sts_TripBits for reason).
Sts_IOFault		IOFault.Inp	I/O Communication Fault Status (0 = OK, 1 = bad).
Alm_Warn	BOOL	Warn.Alm	Alarm: warning of impending trip, overload tripped, or I/O Fault.
Alm_Trip		Trip.Alm	
Alm_IOFault		IOFault.Alm	
Ack_Warn	BOOL	Warn.Ack	Trip Warning, Overload Trip, or I/O Fault alarm has been acknowledged.
Ack_Trip		Trip.Ack	
Ack_IOFault		IOFault.Ack	
Sts_WarnDisabled	BOOL	Warn.Disabled	Trip Warning, Overload Trip, I/O Fault alarm has been disabled by Maintenance.
Sts_TripDisabled		Trip.Disabled	
Sts_IOFaultDisabled		IOFault.Disabled	
Sts_WarnShelved	BOOL	Warn.Shelved	Trip Warning, Overload Trip, or I/O Fault alarm has been shelved by Operator.
Sts_TripShelved		Trip.Shelved	
Sts_IOFaultShelved		IOFault.Shelved	
Sts_WarnSuppressed	BOOL	Warn.Suppressed	Trip Warning, Overload Trip, I/O Fault alarm has been suppressed by Program.
Sts_TripSuppressed		Trip.Suppressed	
Sts_IOFaultSuppressed		IOFault.Suppressed	
Rdy_Trip	BOOL		1 = Ready to receive OCmd_Trip or OCmd_TripReset (enables HMI button).
Rdy_TripReset			
Rdy_Reset	BOOL		1 = At least one alarm or latched shed condition requires reset.
Rdy_ResetAckAll	BOOL		1 = At least one alarm or latched shed condition requires reset or acknowledgement.
P_E30vId	BOOL		Unique Parameter Name for auto-discovery.

E3/E3 Plus Overload Relay Local Configuration Tags

Configuration parameters that are array, string, or structure data types cannot be configured as parameters for Add-On Instructions. Configuration parameters of these types appear as local tags to the Add-On Instruction. Local tags can be configured through the HMI faceplates or in Studio 5000 Logix Designer® application by opening the instruction logic of the Add-On Instruction instance and then opening the Data Monitor on a local tag. These parameters cannot be modified by using controller logic or Logix Designer application export/import functionality.

Table 9 - Local Configuration Tags

Tag Name	Data Type	Default	Description
Cfg_Desc	STRING_40	'Analog Input'	Description for display on HMI. This string is shown in the title bar of the faceplate.
Cfg_Inp1Txt	STRING_20	'Run Feedback'	Text for Input #1 label on HMI
Cfg_Inp2Txt		'Disconnect Closed'	Text for Input #2 label on HMI
Cfg_Inp3Txt		' '	Text for Input #3 label on HMI (E3 Plus only)
Cfg_Inp4Txt		' '	Text for Input #4 label on HMI (E3 Plus only)
Cfg_Label	STRING_20	'Overload Relay'	Label for graphic symbol displayed on HMI. This string appears on the graphic symbol.
Cfg_OutATxt	STRING_20	'Started Energized'	Text for Output A label on HMI
Cfg_OutBTxt		' '	Text for Output B label on HMI (E3 Plus only)
Cfg_Tag	STRING_20	'P_E3Ovld'	Tag name for display on the HMI. This string is shown in the title bar of the faceplate.

Operations

This section describes the primary operations for Add-On Instructions.

Modes

The P_E3Ovld Add-On Instruction does not have modes and does not contain a P_Mode instruction instance. Operator and Program commands are accepted at any time.

Alarms

This instruction uses the following alarms, which are implemented by using embedded P_Alarm and P_Gate Add-On Instructions.

Alarm Name	P_Alarm Name	P_Gate Name	Description
I/O Fault	IOFault	None	Raised when the Inp_IOFault input is true. This input is usually used to indicate to the instruction that communication with the overload relay has failed. The device faceplate will show the I/O Source and Quality as communication failure flag a "Not Ready" diagnostic.
Overload Trip	Trip	None	Raised when the overload relay has tripped, preventing the motor from running. The overload relay must be reset before the motor can be started.
Pending Trip (Warning)	Warn	None	Raised when a motor overload condition is occurring and a trip of the overload relay is imminent. Immediate action must be taken to reduce the load on the motor.

Parameters of the P_Alarm object can be accessed by using the following convention: [P_Alarm Name].[P_Alarm Parameter].

See Rockwell Automation Library of Process Objects: Common Alarm Block (P_Alarm) Reference Manual, publication [SYSLIB-RM002](#), for more information.

Simulation

The P_E3Ovld Add-On Instruction does not have a Simulation capability.

Execution

The following table explains the handling of instruction execution conditions.

Condition	Description
EnableIn False (false rung)	No enableInFalse logic is provided. Instruction parameters hold their last values.
Powerup (prescan, first scan)	Any commands received before first scan are discarded. Embedded P_Alarm instructions are handled in accordance with their standard power-up procedures. See the Reference Manual for the P_Alarm Instruction for more information.
Postscan (SFC transition)	No SFC postscan logic is provided.

See the Logix5000 Controllers Add-On Instructions Programming Manual, publication [1756-PM010](#), for more information.

Programming Example

The following example shows the P_E3Ovld in both a strictly ladder and a combined ladder/function block context.

In both cases, ladder logic is used to copy the Module Defined Data Type for the E3 Overload Module (AB:E3 Plus_ParamBased_Generic:I:0) to the User Defined Type for the E3 Overload Parameter-based Input Assembly (100) (P_E3Ovld_Inp).

A complete ladder example is shown below.

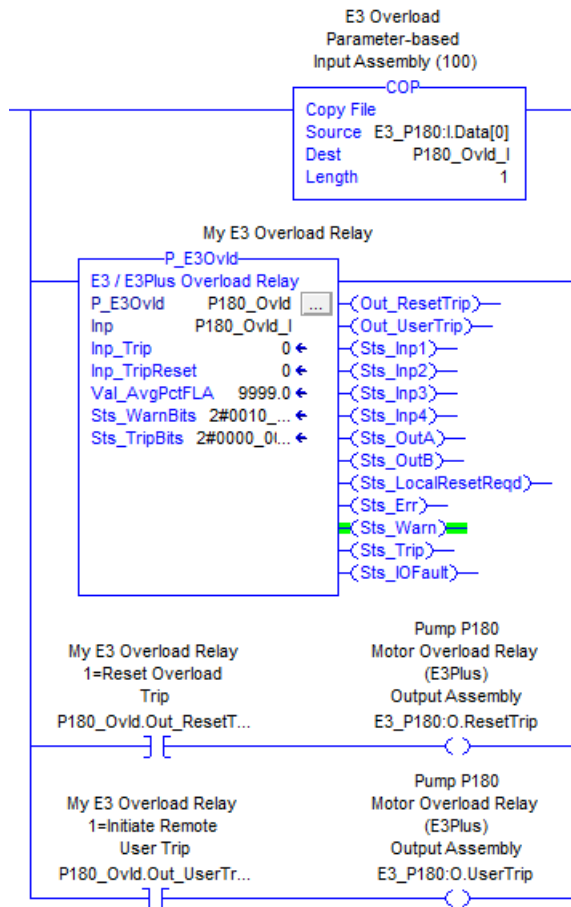

An extended example using Function Blocks is also shown. In this case, the same COP instruction is used in ladder logic, followed by a Jump to Subroutine (JSR) to a Function Block routine.

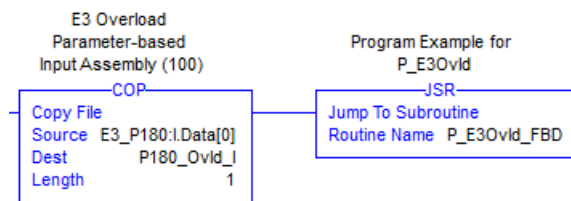

The Function Block Routine shows a typical configuration with the P_E3Ovld Connected to an Interlock (P_Intlk) block followed by a Motor (P_Motor).

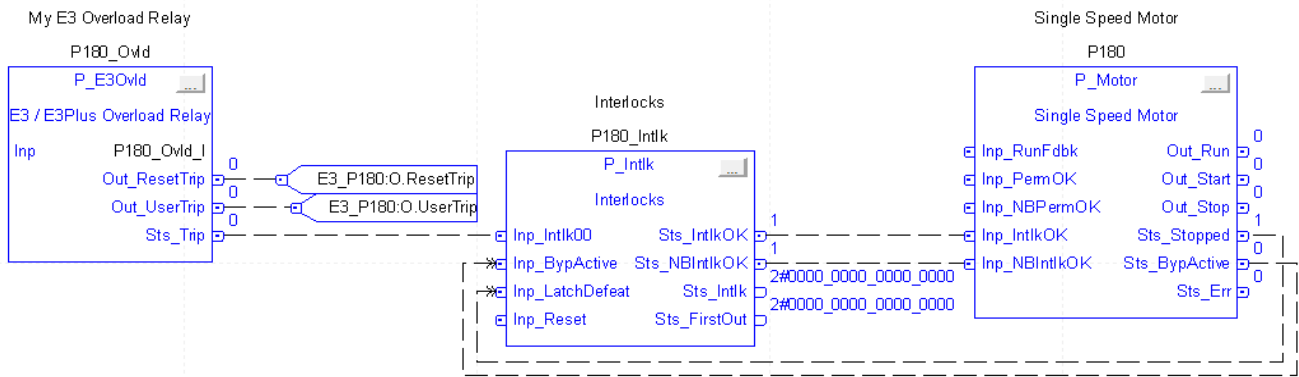

Display Elements

A display element (global object) is created once and can be referenced multiple times on multiple displays in an application. When changes are made to the original (base) object, the instantiated copies (reference objects) are automatically updated. Use of global objects, with tag structures in the ControlLogix system, aid consistency and save engineering time.

Display Element Name	Display Element	Description
GO_P_Ovld GO_P_Ovld1		Standard E3/E3 Plus overload relay global objects.

Graphic symbols provide end users with the following:

- Information on the overload relay’s current state
- Touch field to open the object’s faceplate
- Tooltip to display the object’s configured tag and description

The graphic symbol without the label is designed to be placed under the associated motor’s graphic symbol.

Common attributes of the overload graphic symbols include the following:



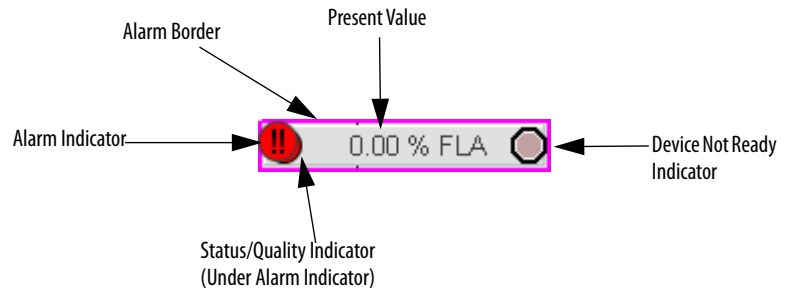

- Graphical representation of the device
- Status/quality indicators
- Present Value of motor current
- Alarm indicator that changes color for the severity of the alarm

- Color changing alarm border that blinks on unacknowledged alarm



Status/Quality Indicators

One of these symbols appears on the graphic symbol when the described condition is true.

Graphic Symbol	Description
	Invalid configuration.
	Data quality bad/failure.
	Data Quality degraded: uncertain, test, simulation, substitution, or out of specification.
	Device not ready to operate.

TIP When the Invalid Configuration indicator appears, you can find what configuration setting is invalid by following the indicators. Click the graphic symbol to open the faceplate. The Invalid Configuration indicator appears next to the appropriate tab at the top of the faceplate to guide you in finding the configuration error. Once you navigate to the tab, the misconfigured item is flagged with this indicator or appears in a magenta box.

For the P_E3Ovld instruction, the Invalid Configuration indicator appears under the following conditions:

- Reset Pulse Timer preset is set to a value less than zero or greater than 2,147,483 seconds.
- Alarm Severity is set to a value less than 1 or greater than 1000.
- Alarm Minimum On Time is set to a value less than zero or greater than 2,147,483 seconds.

TIP When the Not Ready indicator appears, you can find what condition is preventing operation by following the indicators. Click the graphic symbol to open the faceplate. The Not Ready indicator appears next to the appropriate tab at the top of the faceplate to guide you in finding the condition. When you navigate to the tab, the condition preventing operation is flagged.







For the P_E3Ovld instruction, the Device Not Ready indicator appears under the following conditions:

- Device has been tripped at the device or by command.
- I/O Fault.

The I/O Fault has cleared but its shed latch needs to be reset.

Alarm Indicators

One of these symbols appears on the left side of the label to indicate the described alarm condition and the alarm border and label background change color. The alarm border and label background blink if acknowledgement of an alarm condition is required. Once the alarm is acknowledged, the alarm border and label background remain the color that corresponds to the severity of the alarm.

Symbol	Border and Label Background	Description
	No change in color	Alarm Inhibit: an alarm is suppressed by the Program, disabled by Maintenance, or shelved by the Operator.
	White	Return to normal (no alarm condition), but a previous alarm has not been acknowledged.
	Blue	Low severity alarm.
	Yellow	Medium severity alarm.
	Red	High severity alarm.
	Magenta	Urgent severity alarm.
No symbol	No change in color	No alarm or alarm inhibit condition, and all alarms are acknowledged.

See Rockwell Automation Library of Process Objects: Common Alarm Block (P_Alarm) Reference Manual, publication [SYSLIB-RM002](#), for more information.

Using Display Elements

The global objects for P_E3Ovld can be found in the global object file (RA-BAS) Process Graphics Library.ggfx. Follow these steps to use a global object.

1. Copy the global object from the global object file and paste it in the display file.

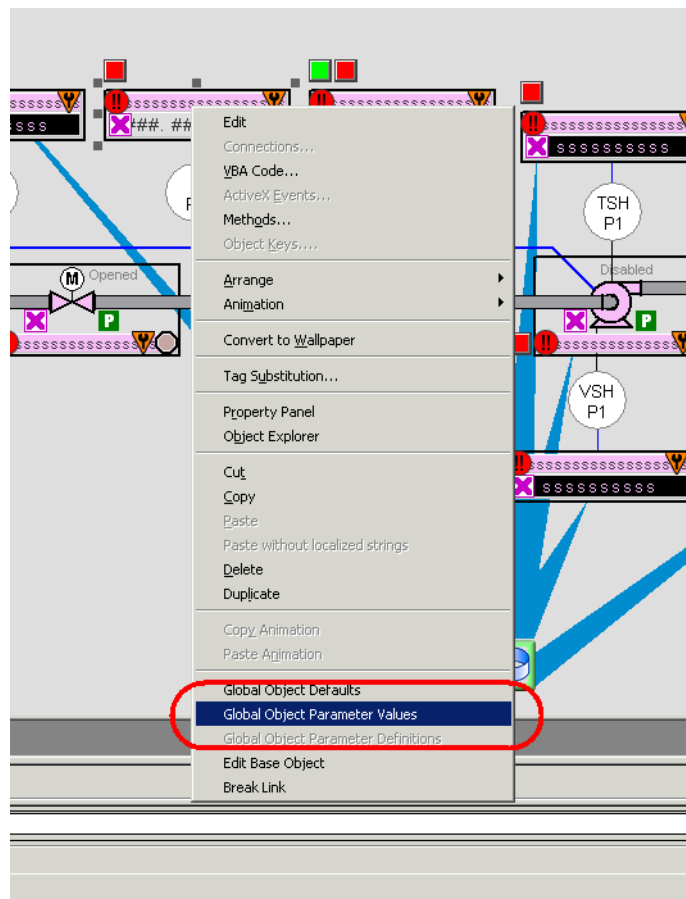

- In the display, right-click the global object and choose Global Object Parameter Values.

The Global Object Parameter Values dialog box appears.

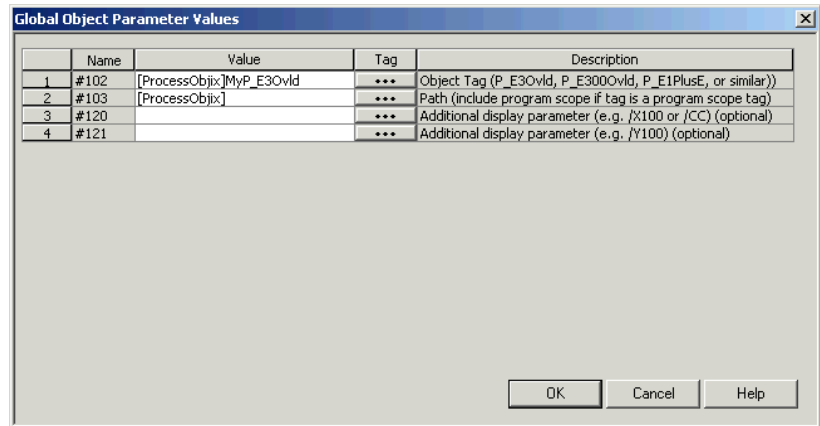

The global object parameters are as follows.

Parameter	Required	Description
#102	Y	Object tag to point to the name of the associated object Add-On Instruction in the controller.
#103	Y	Path used for display navigation features to other objects. Include program scope if tag is a program scope tag.
#120	N	Additional parameter to pass to the display command to open the faceplate. Typically used to define position for the faceplate.
#121	N	Additional parameter to pass to the display command to open the faceplate. if defining X and Y coordinate, separate parameters so that X is defined by #120 and Y is defined by #121. This lets these same parameters to be used in subsequent display commands originating from the faceplate.

- In the Value column, type the tag or value as specified in the Description column.

TIP Click the ellipsis (...) to browse and select a tag.
Values for items marked '(optional)' can be left blank.

- Click OK.

Faceplate

The P_E3Ovld faceplate consists of five tabs and each tab consists of one or more pages.

The title bar of the faceplate contains the value of local configuration tags Cfg_Tag and Cfg_Desc.

Tag - Description

The Operator tab is displayed when the faceplate is initially opened. Click the appropriate icon at the top of the faceplate to access a specific tab.

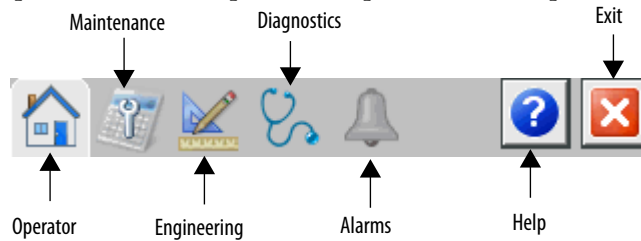

The faceplate provides the means for operators, maintenance workers, engineers, and others to interact with the P_E3Ovld instruction instance, including viewing its status and values and manipulating it through its commands and settings. When a given input is restricted via FactoryTalk View security, the required user security code letter is shown in the tables that follow.

Operator Tab

The Faceplate initially opens to the Operator ('Home') tab. From here, an operator can monitor the device status and if so configured, remotely trip or reset the overload relay.

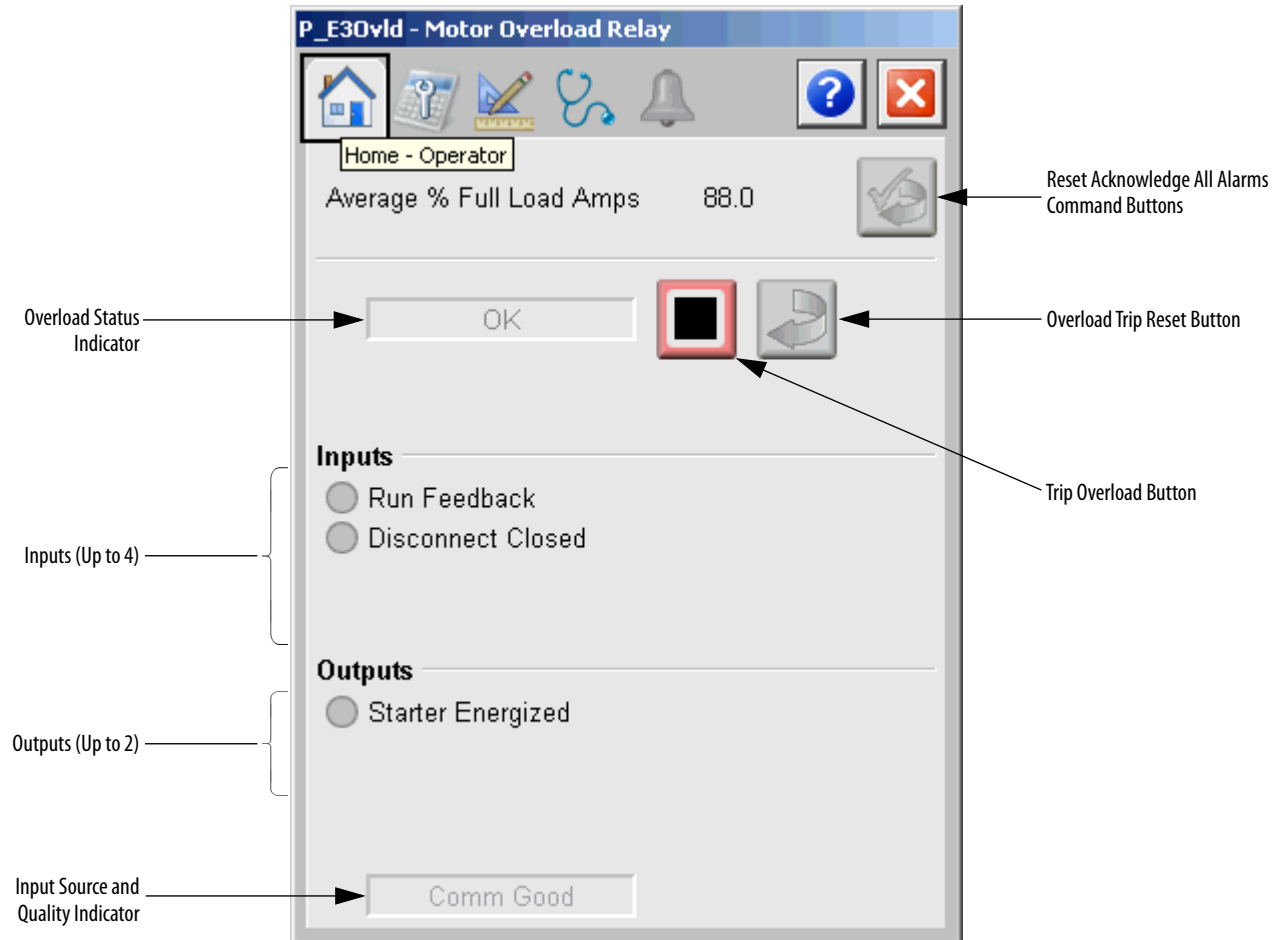



The Operator tab shows the following information:

- Warning of impending overloads.
- Overload status indicator.
- State of relay's inputs and outputs.
- State of I/O communications.
- Input Source and Quality indicator (See 'SrcQ' in the Output parameters table on [page 15](#) for details).







The following table shows the functions included on the Operator tab.

Table 10 - Operator Tab Description

Function	Action	Security
	Click to trip the overload relay.	Normal Operation of Devices (Code A) when Cfg_AllowOperTrip = 1 Equipment Maintenance (Code C) when Cfg_AllowMaintTrip = 1
	Click to reset the overload trip button.	Normal Operation of Devices (Code A) when Cfg_AllowOperTrip = 1 Equipment Maintenance (Code C) when Cfg_AllowMaintTrip = 1
	Click to reset and acknowledge all alarms.	Acknowledge Alarms (Code F)

The following table shows the alarm status symbols used on the Operator tab.

Table 11 - Operator Tab Alarm Status

Graphic Symbol	Alarm Status
	In Alarm (Active Alarm)
	In Alarm and Acknowledged
	Out of Alarm but not Acknowledged
	Alarm Suppressed (by Program)
	Alarm Disabled (by Maintenance)
	Alarm Shelved (by Operator)

Alarm indicators appear on the Operator tab when the corresponding alarm occurs.

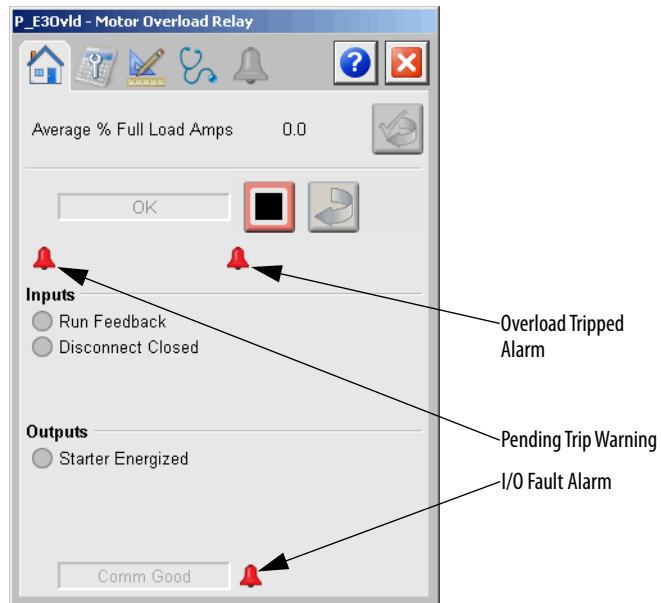

Maintenance Tab

Maintenance personnel use the information and controls on the Maintenance tab to adjust device parameters, troubleshoot and temporarily work around device problems, and disable the device for routine maintenance.

The Maintenance tab is divided into two pages.

Maintenance Tab Page 1

Page 1 of the Maintenance tab has indicators for various reasons why the relay tripped.

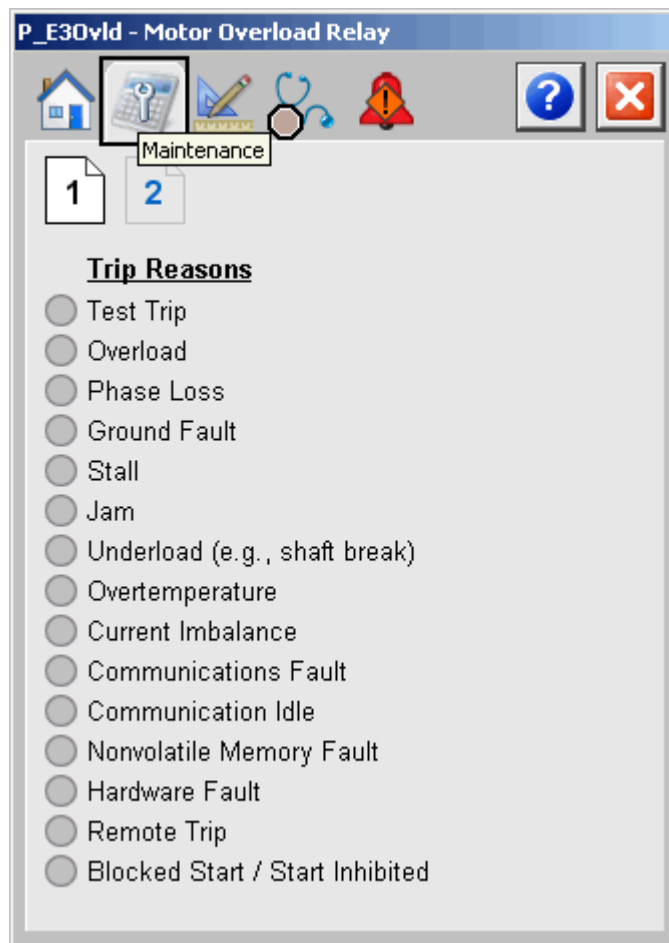

Maintenance Tab Page 2

Page 2 of the Maintenance tab shows various reasons for the pending trip of the relay.

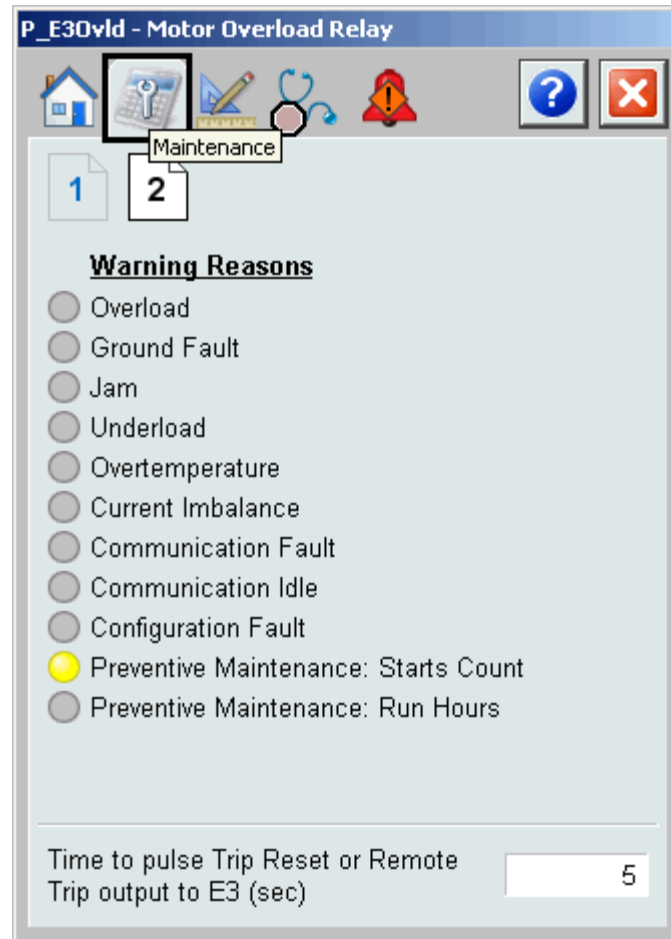

Table 12 - Maintenance Tab Page 2 Description

Function	Action	Security	Configuration Parameters
Time to pulse Trip Reset or Remote Trip output to E3 (seconds)	Type the number of seconds (0...2,147,483) to pulse Trip Reset or Remote Trip output to E3.	Configuration and Tuning Maintenance (Code D)	Cfg_PulseT

Engineering Tab

The Engineering tab provides access to device configuration parameters and ranges, options for device and I/O setup, displayed text, and faceplate-to-faceplate navigation settings, for initial system commissioning or later system changes.

The Engineering tab is divided into two pages.

Engineering Tab Page 1

On page 1 of the Engineering tab, you can configure the description, label, tag, input labels, and output labels for the device.

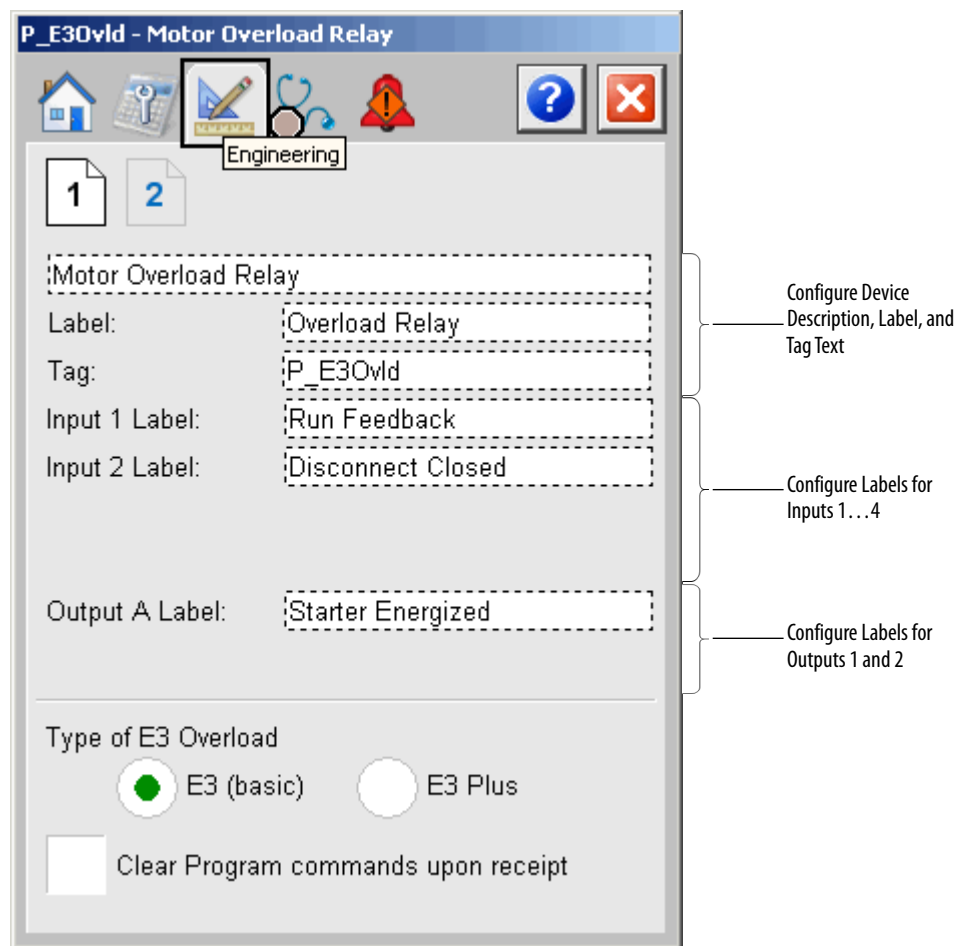

The following table lists the functions on page 1 of the Engineering tab.

Table 13 - Engineering Tab Page 1 Description

Function	Action	Security	Configuration Parameters
Description	Type the device description to show on the faceplate title bar.	Engineering Configuration (Code E)	Cfg_Desc
Label	Type the label to show on the graphic symbol.		Cfg_Label
Tag	Type the tag name to show on the faceplate and on the Tooltip. IMPORTANT: Pausing the mouse over this field displays a tool tip with the configured Logix tag/path.		Cfg_Tag
Input Labels	Type the names for inputs 1 . . . 4. NOTE: Inputs 3 and 4 are available and displayed only with E3 Plus.		<ul style="list-style-type: none"> • Cfg_Inp1Txt • Cfg_Inp2Txt • Cfg_Inp3Txt • Cfg_Inp4Txt
Output Labels	Type the names for outputs 1 and 2. NOTE: Output 2 is available and displayed only with E3 Plus.		<ul style="list-style-type: none"> • Cfg_OutATxt • Cfg_OutBTxt
Type of E3 Overload E3 (basic) E3 Plus	Click to select the type of E3 Overload used. NOTE: E3 Plus has two additional inputs and one additional output.		Cfg_E3Plus
Clear Program Commands on Receipt	Check to clear Program commands on receipt.		Cfg_PCmdClear

Engineering Tab Page 2

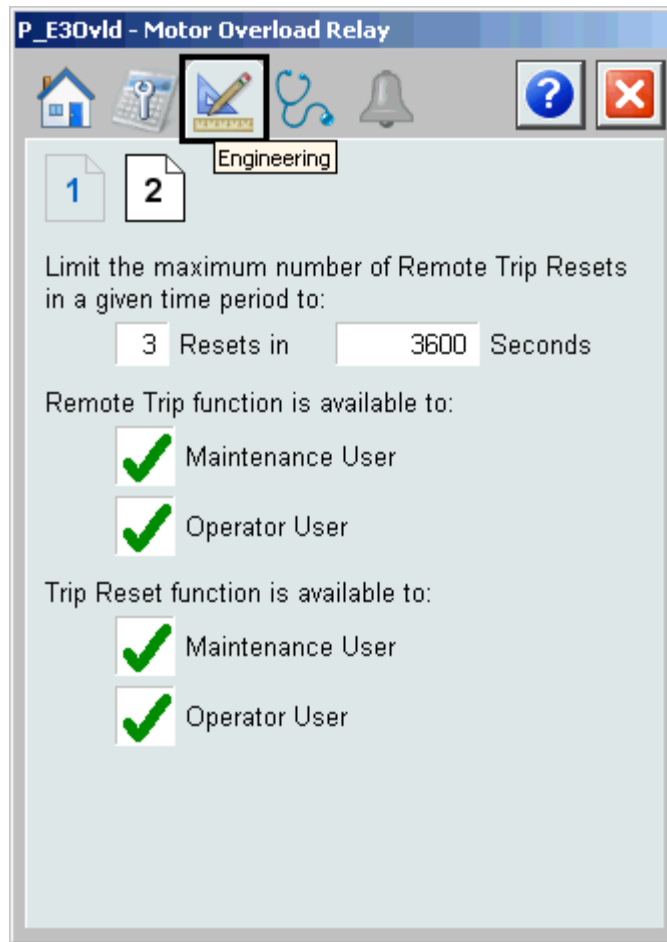

The following table lists the functions on page 2 of the Engineering tab.

Table 14 - Engineering Tab Page 2 Description

Function	Action	Security	Configuration Parameters
Limit the maximum number of remote Trip Resets in a given time period to: x Resets in y Seconds	Type the maximum number of resets (1...3) in a given number of seconds (0...2,147,483). IMPORTANT: Setting the time to approximate 10 seconds or less allows unlimited Remote Trip resets.	Engineering Configuration (Code E)	<ul style="list-style-type: none"> • Cfg_LocalResetReqdNum • Cfg_LocalResetReqdT
Remote Trip function is available to: Maintenance User Operator User	Check to let the Maintenance and/or Operator User use the Remote Trip function.		<ul style="list-style-type: none"> • Cfg_AllowMaintTrip • Cfg_AllowOperTrip
Trip Reset function is available to: Maintenance User Operator User	Check to let the Maintenance and/or Operator User use the Trip Reset function.		<ul style="list-style-type: none"> • Cfg_AllowMaintReset • Cfg_AllowOperReset

Diagnostics Tab

The Trends tab shows trend charts of key device data over time. These faceplate trends provide a quick view of current device performance to supplement, but not replace, dedicated historical or live trend displays.

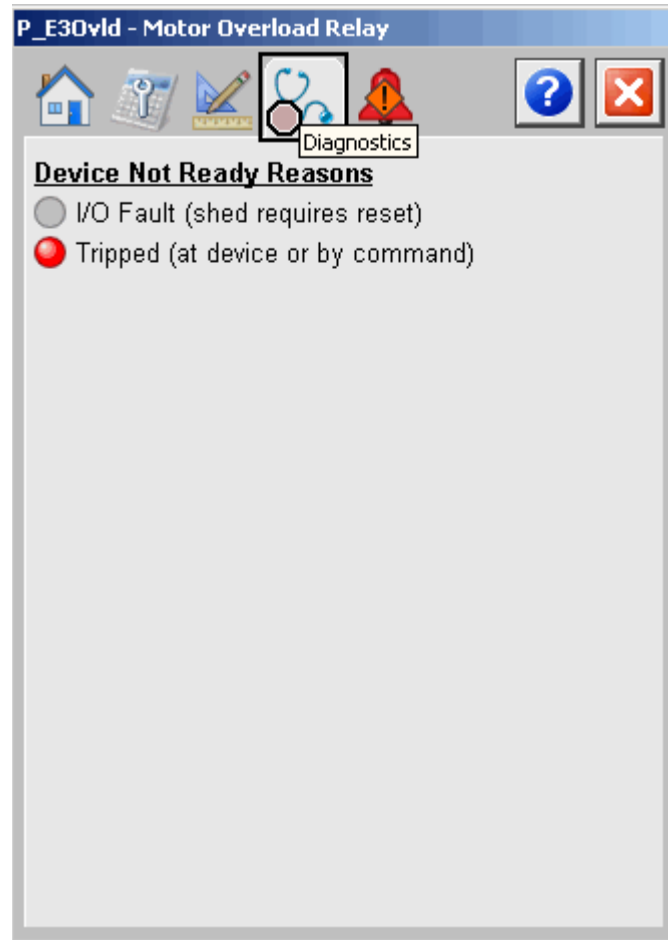

The preceding image indicates that the overload relay has tripped either at the device or by command. More information on this alarm can be seen on the [Alarms Tab on page 36](#).

Alarms Tab

The Alarms Tab shows all available alarms for the device and their current status. From here, alarms can be acknowledged and reset. Click an alarm name to open the alarm detail faceplate for that alarm, where the alarm can be shelved by the operator, disabled by maintenance personnel, or configured by engineering.

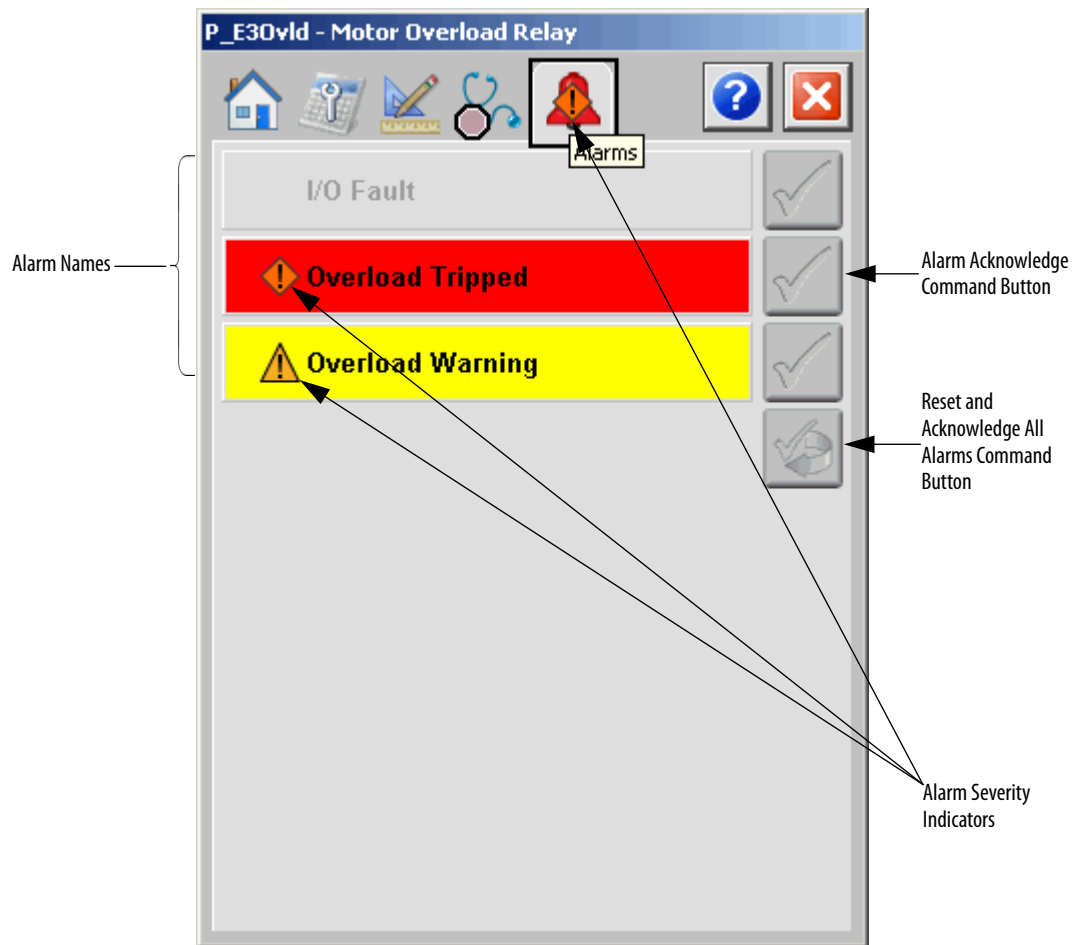

Click an alarm name to open the P_Alarm faceplate for that alarm. From the P_Alarm faceplate, you can configure and perform additional operations on the alarm.



If an alarm is active, the panel behind the alarm changes color to match the severity of the alarm. The color of the bell icon at the top of the faceplate shows the severity of the highest active alarm, and the icon blinks if any alarm is unacknowledged or requires reset.

Table 15 - Alarm Severity Colors

Color	Definition
Magenta	Urgent
Red	High
Yellow	Medium
Blue	Low
White (bell icon)	Alarm has cleared but is unacknowledged
Background (Light Gray)	No alarm

The following table shows the functions on the Alarms tab.

Table 16 - Alarms Tab Description

Function	Action	Security
Alarm Name	Click an alarm name to open the associated P_Alarm faceplate.	None
	Click to acknowledge the alarm.	Acknowledge Alarms (Code F)
	Click to reset and acknowledge all alarms.	

When the Reset and Acknowledge All Alarms button is enabled, the panel behind the alarm blinks, indicating the alarm requires acknowledgement or reset. The Alarm Acknowledge button is enabled if the alarm requires acknowledgment. Click the button with the check mark to acknowledge the alarm.







See Rockwell Automation Library of Process Objects: Common Alarm Block (P_Alarm) Reference Manual, publication [SYSLIB-RM002](#), for more information.

E3/E3 Plus Overload Relay Faceplate Help



E3 Overload Faceplate Help



Status Indicators

 Invalid Configuration	 Alarm Inhibit (Suppressed or Disabled)
 Communication Failure	 Maintenance Bypass Active
 Communication Uncertain	 Device in Simulation or Test
 The Device is Not Ready To Operate	

Commands

 Operator Command to Trip Overload	 Operator Command to reset the overload trip
---	--

Alarms



Pending Trip Warning
The Pending Trip Warning is triggered when a motor overload condition is occurring and an overload trip is imminent.

Overload Trip
The Overload Trip alarm occurs when the overload has tripped.

I/O Fault Alarm
The I/O Fault Alarm is triggered when a controller hardware or communication fault is detected.

Rockwell Automation Support

Rockwell Automation provides technical information on the Web to assist you in using its products.

At <http://www.rockwellautomation.com/support> you can find technical and application notes, sample code, and links to software service packs. You can also visit our Support Center at <https://rockwellautomation.custhelp.com/> for software updates, support chats and forums, technical information, FAQs, and to sign up for product notification updates.

In addition, we offer multiple support programs for installation, configuration, and troubleshooting. For more information, contact your local distributor or Rockwell Automation representative, or visit <http://www.rockwellautomation.com/services/online-phone>.

Installation Assistance

If you experience a problem within the first 24 hours of installation, review the information that is contained in this manual. You can contact Customer Support for initial help in getting your product up and running.

United States or Canada	1.440.646.3434
Outside United States or Canada	Use the Worldwide Locator at http://www.rockwellautomation.com/rockwellautomation/support/overview.page , or contact your local Rockwell Automation representative.

New Product Satisfaction Return

Rockwell Automation tests all of its products to help ensure that they are fully operational when shipped from the manufacturing facility. However, if your product is not functioning and needs to be returned, follow these procedures.

United States	Contact your distributor. You must provide a Customer Support case number (call the phone number above to obtain one) to your distributor to complete the return process.
Outside United States	Please contact your local Rockwell Automation representative for the return procedure.

Documentation Feedback

Your comments will help us serve your documentation needs better. If you have any suggestions on how to improve this document, complete this form, publication [RA-DU002](#), available at <http://www.rockwellautomation.com/literature/>.

Rockwell Automation maintains current product environmental information on its website at <http://www.rockwellautomation.com/rockwellautomation/about-us/sustainability-ethics/product-environmental-compliance.page>.

Rockwell Otomasyon Ticaret A.Ş., Kar Plaza İş Merkezi E Blok Kat:6 34752 İçerenköy, İstanbul, Tel: +90 (216) 5698400

www.rockwellautomation.com

Power, Control and Information Solutions Headquarters

Americas: Rockwell Automation, 1201 South Second Street, Milwaukee, WI 53204-2496 USA, Tel: (1) 414.382.2000, Fax: (1) 414.382.4444
Europe/Middle East/Africa: Rockwell Automation NV, Pegasus Park, De Kleetlaan 12a, 1831 Diegem, Belgium, Tel: (32) 2 663 0600, Fax: (32) 2 663 0640
Asia Pacific: Rockwell Automation, Level 14, Core F, Cyberport 3, 100 Cyberport Road, Hong Kong, Tel: (852) 2887 4788, Fax: (852) 2508 1846

Publication SYSLIB-RM050C-EN-P - February 2017

Supersedes Publication SYSLIB-RM050B-EN-P/January 2016

Copyright © 2017 Rockwell Automation, Inc. All rights reserved. Printed in the U.S.A.