

Rockwell Automation Library of Process Objects: Analog Input Channel (P_AIChan)

Version 3.5

IMPORTANT

This manual applies to the Rockwell Automation Library of Process Objects version 3.5 or earlier.
For Rockwell Automation Library of Process Objects version 5.0, see

- [PROCES-RM200](#)

For Rockwell Automation Library of Process Objects version 4.0 or later, use the following manuals:

- [PROCES-RM013](#) contains logic instructions
- [PROCES-RM014](#) contains display elements



Important User Information

Read this document and the documents listed in the additional resources section about installation, configuration, and operation of this equipment before you install, configure, operate, or maintain this product. Users are required to familiarize themselves with installation and wiring instructions in addition to requirements of all applicable codes, laws, and standards.

Activities including installation, adjustments, putting into service, use, assembly, disassembly, and maintenance are required to be carried out by suitably trained personnel in accordance with applicable code of practice.

If this equipment is used in a manner not specified by the manufacturer, the protection provided by the equipment may be impaired.

In no event will Rockwell Automation, Inc. be responsible or liable for indirect or consequential damages resulting from the use or application of this equipment.

The examples and diagrams in this manual are included solely for illustrative purposes. Because of the many variables and requirements associated with any particular installation, Rockwell Automation, Inc. cannot assume responsibility or liability for actual use based on the examples and diagrams.

No patent liability is assumed by Rockwell Automation, Inc. with respect to use of information, circuits, equipment, or software described in this manual.

Reproduction of the contents of this manual, in whole or in part, without written permission of Rockwell Automation, Inc., is prohibited.

Throughout this manual, when necessary, we use notes to make you aware of safety considerations.



WARNING: Identifies information about practices or circumstances that can cause an explosion in a hazardous environment, which may lead to personal injury or death, property damage, or economic loss.



ATTENTION: Identifies information about practices or circumstances that can lead to personal injury or death, property damage, or economic loss. Attentions help you identify a hazard, avoid a hazard, and recognize the consequence.

IMPORTANT

Identifies information that is critical for successful application and understanding of the product.

Labels may also be on or inside the equipment to provide specific precautions.



SHOCK HAZARD: Labels may be on or inside the equipment, for example, a drive or motor, to alert people that dangerous voltage may be present.



BURN HAZARD: Labels may be on or inside the equipment, for example, a drive or motor, to alert people that surfaces may reach dangerous temperatures.



ARC FLASH HAZARD: Labels may be on or inside the equipment, for example, a motor control center, to alert people to potential Arc Flash. Arc Flash will cause severe injury or death. Wear proper Personal Protective Equipment (PPE). Follow ALL Regulatory requirements for safe work practices and for Personal Protective Equipment (PPE).

Preface	Software Compatibility and Content Revision.....	5
	Additional Resources.....	5
Analog Input Channel (P_AIChan)	Functional Description.....	8
	Required Files.....	9
	Controller File.....	9
	Visualization Files.....	9
	Controller Code.....	11
	Analog Input Channel Input Structure.....	11
	Analog Input Channel Output Structure.....	13
	Analog Input Channel Local Configuration Tags.....	16
	Operations.....	16
	Modes.....	16
	Alarms.....	17
	Simulation.....	18
	Execution.....	18
	Programming Example.....	18
	Display Elements.....	19
	Status/Quality Indicators.....	19
	Threshold Indicators.....	20
	Alarm Indicators.....	21
	Faceplate.....	22
	Operator Tab.....	23
	Maintenance Tab.....	25
	Engineering Tab.....	27
	Alarms Tab.....	32
	Analog Input Channel Faceplate Help.....	34

Notes:

This manual contains new and updated information. Changes throughout this revision are marked by change bars, as shown to the right of this paragraph.

Software Compatibility and Content Revision

Table 1 - Summary of Changes

Topic	Page
Changed version from 3_1 to 3_5	9
Visualization Files - Split visualization files table by type and reordered to align with installation requirements	9
Updated Alarm descriptions	17
Updated Status/Quality Indicator descriptions	19

For the latest compatible software information and to download the Rockwell Automation® Library of Process Objects, see the Product Compatibility and Download Center at <http://www.rockwellautomation.com/rockwellautomation/support/pcdc.page>.

For general library considerations, see Rockwell Automation Library of Process Objects, publication [PROCES-RM002](#).

Additional Resources

These documents contain additional information concerning related products from Rockwell Automation.

Resource	Description
PlantPAx® Distribution Control System Selection Guide, publication PROCES-SG001	Provides information to assist with equipment procurement for your PlantPAx system.
PlantPAx Distribution Control System Reference Manual, publication PROCES-RM001	Provides characterized recommendations for implementing your PlantPAx system.
Rockwell Automation Library of Process Objects, publication PROCES-RM002	Provides general considerations for the Rockwell Automation system library of process objects.
FactoryTalk® View Machine Edition User Manual, publication VIEWME-UM004	Provides details on how to use this software package for creating an automation application.
FactoryTalk View Site Edition User Manual, publication VIEWSE-UM006	Provides details on how to use this software package for developing and running human-machine interface (HMI) applications that can involve multiple users and servers, distributed over a network.
Logix5000™ Controllers Add-On Instructions Programming Manual, publication 1756-PM010	Provides information for designing, configuring, and programming Add-On Instructions.
Rockwell Automation Library of Process Objects: Common Alarm Block (P_Alarm) Reference Manual, publication SYSLIB-RM002	Details how to monitor an input condition to raise an alarm. Information includes acknowledging, resetting, inhibiting, and disabling an alarm. Generally the P_Alarm faceplate is accessible from the Alarms tab.

You can view or download publications at <http://www.rockwellautomation.com/literature/>. To order paper copies of technical documentation, contact your local Allen-Bradley® distributor or Rockwell Automation sales representative.

Notes:

Analog Input Channel (P_AIChan)

The P_AIChan (Analog Input Channel) Add-On Instruction monitors one analog input channel and provides one configurable alarm. There are no dedicated display elements for this instruction. The faceplate is called from the associated analog input instruction faceplate.

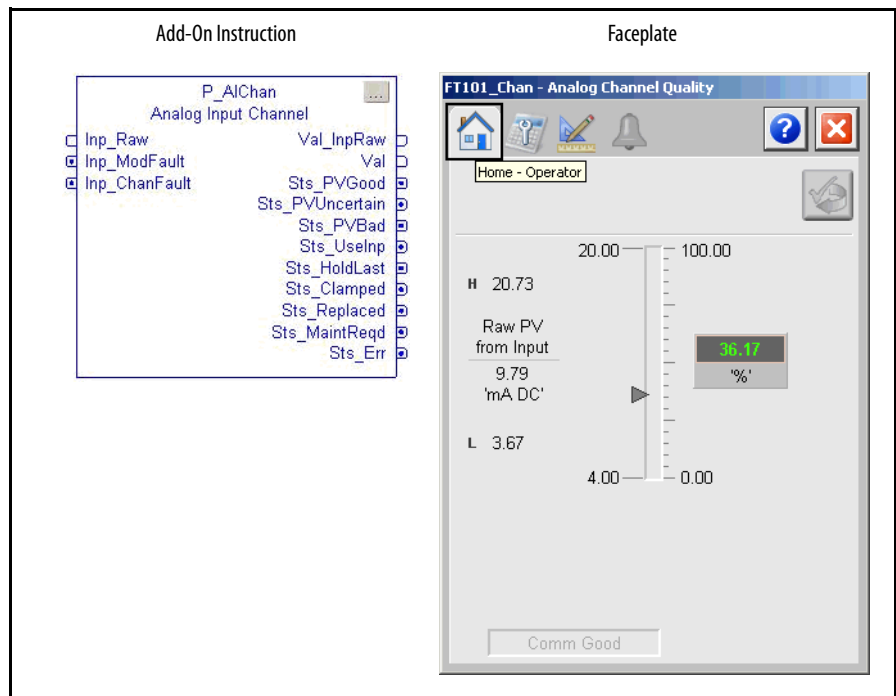

This instruction is usually associated with other instructions, with one instance being used for each analog input of the associated instruction.

This instruction can be integrated with the following instructions in the Rockwell Automation Library of Process Objects:

- Basic Analog Input (P_AIn)
- Advanced Analog Input (P_AInAdv)
- Dual Sensor Analog Input (P_AInDual)
- Multiple Analog Input (P_AInMulti)
- Flowmeter Dosing (P_DoseFM)
- Weigh Scale Dosing (P_DoseWS)

Functional Description

The P_AIChan Add-On Instruction monitors one analog input channel for the following conditions:

- Invalid configuration
- I/O module fault
- Input out of range
- Instrument reports the following conditions:
 - Out of specification (uncertain)
 - Function check (substitute PV entered manually)
 - Maintenance required
- Channel fault
- Input not-a-number (floating-point exception)
- Input stuck (unchanging)

For each condition, the Process Variable (PV) quality to report can be configured as follows:

- Good
- Uncertain
- Bad (raises Fail alarm)

For each condition, the following actions can be taken:

- Pass the PV through unchanged
- Apply a configured replacement PV value
- Use the last good PV value

Required Files

Add-On Instructions are reusable code objects that contain encapsulated logic that can streamline implementing your system. This lets you create your own instruction set for programming logic as a supplement to the instruction set provided natively in the ControlLogix® firmware. An Add-On Instruction is defined once in each controller project, and can be instantiated multiple times in your application code as needed.

Controller File

The P_AIChan_3_5-00_AOIL5X Add-On Instruction must be imported into the controller project to be used in the controller configuration. The service release number (boldfaced) can change as service revisions are created.

Visualization Files

<http://www.rockwellautomation.com/global/support/pcdc.page> This Add-On Instruction has associated visualization files that provide a common user interface. These files can be downloaded from the Product Compatibility and Download Center at <http://www.rockwellautomation.com/rockwellautomation/support/pcdc.page>.

IMPORTANT The visualization file dependencies require Process Library content imports to occur in a specific order as reflected in the following tables:

- Images
- Global Objects
- Standard Displays
- HMI Tags
- Macros

Images are external graphic files that can be used in displays. They must be imported for FactoryTalk View to make use of them.

When PNG files are imported, they are renamed by FactoryTalk View with a .bmp file extension, but retain a .png format.

Table 2 - Visualization Files: Images (.png)

FactoryTalk View SE Software	FactoryTalk View ME Software	Description
All .png files in the images folder	All .png files in the images folder	These are the common icons used in the global objects and standard displays for all Process Objects.

The Global Object files (.ggfx file type) in the following table are Process Library display elements that are created once and referenced multiple times on multiple displays in an application. When changes are made to a Global Object, all instances in the application are automatically updated.

Table 3 - Visualization Files: Global Objects (.ggfx)

FactoryTalk View SE Software	FactoryTalk View ME Software	Description
(RA-BAS) Common Faceplate Objects	(RA-BAS-ME) Common Faceplate Objects	Global objects used on process object faceplates.
(RA-BAS) Process Alarm Objects	(RA-BAS-ME) Process Alarm Objects	Global objects used for managing alarms on process object faceplates.
(RA-BAS) Process Faceplate Analog Objects	(RA-BAS-ME) Process Faceplate Analog Objects	Analog global objects used on process object faceplates.
(RA-BAS) Process Help Objects	(RA-BAS-ME) Process Help Objects	Global objects used for all process objects help displays.

The Standard Display files (.gfx file type) in the following table are the Process Library displays that you see at runtime.

Table 4 - Visualization Files: Standard Displays (.gfx)

FactoryTalk View SE Software	FactoryTalk View ME Software	Description
(RA-BAS) Common-AnalogEdit	N/A	Faceplate used for analog input data entry. The FactoryTalk View ME faceplates use the native analog input data entry so no file is required.
(RA-BAS) P_AIChan-Faceplate	(RA-BAS-ME) P_AIChan-Faceplate	The faceplate that is used for the object.
(RA-BAS) P_AIChan-Help	(RA-BAS-ME) P_AIChan-Help	The Help display that is used for the object.
(RA-BAS) P_Alarm-Faceplate	(RA-BAS-ME) P_Alarm-Faceplate	The faceplate that is used for the object
(RA-BAS) P_Alarm-Help	(RA-BAS-ME) P_Alarm-Help	Alarm Help information that is accessed from the P_Alarm faceplate.

HMI Tags are created in a FactoryTalk View ME application to support tab switching on Process Library faceplates. The HMI tags may be imported via the comma-separated values file (.csv file type) in the following table.

Table 5 - Visualization Files: HMI Tags (.csv)

FactoryTalk View SE Software	FactoryTalk View ME Software	Description
N/A	FTVME_PlantPaxLib_Tags_3_5_XX.csv where XX = the service release number.	These tags must be imported into the FactoryTalk View ME project to support switching tabs on any Process Object faceplate.

Controller Code

This section describes the parameter references for this Add-On Instruction.

Analog Input Channel Input Structure

Input parameters include the following:

- Input data elements (Inp_) are typically used to connect field inputs from I/O modules or signals from other objects.
- Configuration data elements (Cfg_) are used to set configurable capabilities and features of the instruction.
- Commands (PCmd_, OCmd_, MCmd_) are used by program logic, operators, and maintenance personnel to request instruction actions.

Table 7 - P_AIChan Input Parameters

Input Parameter	Data Type	Alias For	Default	Description
EnableIn	BOOL		1	<p>Ladder Diagram: If the rung-in condition is true, the instruction's Logic routine executes. If the rung-in condition is false, the instruction's EnableInFalse routine executes.</p> <p>Function Block Diagram: If true, or not connected, the instruction's Logic routine executes. If the parameter is exposed as a pin and wired, and the pin is false, the instruction's EnableInFalse routine executes.</p> <p>Structured Text: No effect. The instruction's Logic routine executes.</p>
Inp_Raw	REAL		4.0	Input signal from transmitter or sensor (raw units).
Inp_ModFault	BOOL		0	1 = I/O module failure or module communication status bad 0 = OK
Inp_ChanFault	BOOL		0	1 = I/O channel fault or failure 0 = OK
Inp_OutOfSpec	BOOL		0	1 = Out of specification (PV uncertain, from instrument) 0 = OK
Inp_FuncCheck	BOOL		0	1 = Function check (PV substituted, from instrument) 0 = OK
Inp_MaintReqd	BOOL		0	1 = Maintenance required (from instrument).
Inp_Reset	BOOL		0	Input parameter used to programatically reset alarms. When set to 1, all alarms requiring reset are reset.
Cfg_FailOnUncertain	BOOL		0	1 = Raise Sts_Fail (and alarm) if Bad or Uncertain quality 0 = Only if Bad quality
Cfg_PCmdClear	BOOL	Mode.Cfg_PCmdClear	1	When this parameter is 1, program commands are cleared once they are acted upon. When set to 0, program commands remain set until cleared by the application program logic. IMPORTANT: Clearing this parameter online can cause unintended program command execution.
Cfg_HasFailAlm	BOOL	Fail.Cfg_Exists	0	This parameter determines whether the corresponding alarm exists and is checked or if the alarm does not exist and is not used. When this parameter is 1, the corresponding alarm exists.

Table 7 - P_AIChan Input Parameters

Input Parameter	Data Type	Alias For	Default	Description
Cfg_FailResetReqd	BOOL	Fail.Cfg_ResetReqd	0	This parameters determines whether a reset is required to clear the alarm status. When this parameter is 1, the alarm is latched ON when the alarm occurs. After the alarm condition returns to normal, a reset is required to clear the alarm status (for example, OCmd_Reset, Inp_Reset, or Fail.OCmd_Reset are required to clear Alm_Fail alarm after the alarm is set and the value returns to normal). When this parameter is 0, no reset is required and the alarm status is cleared when the alarm condition returns to normal. IMPORTANT: If the reset clears the alarm, it also acknowledges the alarm.
Cfg_FailAckReqd	BOOL	Fail.Cfg_AckReqd	1	This parameter determines whether an acknowledgement is required for an alarm. When this parameter is 1, the acknowledge (ack) bit is cleared when the alarm occurs. An acknowledge command (for example, PCmd_FailAck or Fail.OCmd_Ack) is required to acknowledge the alarm. When set to 0, the Acknowledge bit is set when an alarm occurs indicating an acknowledged alarm and no acknowledge command is required.
Cfg_FailSeverity	INT	Fail.Cfg_Severity	1000	This parameter determines the severity of each alarm. This drives the color and symbol that is used to indicate alarm status on the faceplate and global object. The following are valid values: 1...250 = Low 251...500 = Medium 501...750 = High 751...1000 = Urgent IMPORTANT: For FactoryTalk View software version 7.0, this severity parameter drives only the indication on the global object and faceplate. The Alarms and Events definition of severity drives the color and symbol that is used on the alarm banner and alarm summary as well as the value returned by FactoryTalk Alarms and Events display commands.
Cfg_InpRawMin	REAL		4.0	Input (unscaled) minimum for scaling (raw units).
Cfg_InpRawMax	REAL		20.0	Input (unscaled) maximum for scaling (raw units).
Cfg_PVEUMin	REAL		0.0	Process Variable (PV) (output) minimum for scaling (engineering units).
Cfg_PVEUMax	REAL		100.0	PV (output) maximum for scaling to engineering units. TIP The P_AIChan instruction supports reverse scaling; either the raw (input) or engineering (scaled) range can be reversed (maximum less than minimum).
Cfg_PVHiLim	REAL		1.50E+38	PV high clamping threshold (engineering units).
Cfg_PVLoLim	REAL		-1.50E+38	PV low clamping threshold (engineering units).
Cfg_InpOORHiLim	REAL		20.733334	Out-of-Range (fail) high limit (raw units).
Cfg_InpOORLoLim	REAL		3.6666667	Out-of-Range (fail) low limit (raw units).
Cfg_InpOORDB	REAL		0.06666667	Out-of-Range (fail) high/low deadband (raw units).
Cfg_InpOOROnDly	DINT		0	Minimum time out-of-range to raise status (seconds).
Cfg_InpOOROffDly			0	Minimum time in-range to clear out-of-range status (seconds).
Cfg_InpOORAction	SINT		1	PV action on: Out-of-range, stuck (unchanging), PV not a number, I/O module fault, I/O channel fault, Inp_PVUncertain, function check, maintenance required, or AOI configuration error: 1 = Pass input PV through unchanged 2 = Hold last good PV value 3 = Replace PV value with Cfg_PVReplaceVal
Cfg_InpStuckAction			2	
Cfg_InpNaNAction			2	
Cfg_ModFaultAction			2	
Cfg_ChanFaultAction			2	
Cfg_OutOfSpecAction			1	
Cfg_FuncCheckAction			3	
Cfg_MaintReqdAction			3	
Cfg_CfgErrAction				

Table 7 - P_AIChan Input Parameters

Input Parameter	Data Type	Alias For	Default	Description
Cfg_InpOORQual	SINT		3	PV quality to report for: Out-of-range, stuck (unchanging), PV not a number, I/O module fault, I/O channel fault, Inp_PVUncertain, function check, maintenance required, or AOI configuration error: 1 = Good 2 = Uncertain 3 = Bad
Cfg_InpStuckQual			1	
Cfg_InpNaNQual			3	
Cfg_ModFaultQual				
Cfg_ChanFaultQual				
Cfg_OutOfSpecQual			2	
Cfg_FuncCheckQual			3	
Cfg_MaintReqdQual				
Cfg_CfgErrQual				
Cfg_StuckT	DINT		60	Time with no change in input to raise stuck status (s).
Cfg_PVReplaceVal	REAL		0.0	Value (engineering units) to use to replace PV when action = replace.
PCmd_FailAck	BOOL	Fail.PCmd_Ack	0	<ul style="list-style-type: none"> Set PCmd_<Alarm>Ack to 1 to Acknowledge alarm The parameter is reset automatically
PCmd_FailSuppress		Fail.PCmd_Suppress		When Cfg_PCmdClear is 1: <ul style="list-style-type: none"> Set PCmd_<Alarm>Suppress to 1 to suppress alarm Set PCmd_<Alarm>Unsuppress to 1 to unsuppress alarm These parameters reset automatically
PCmd_FailUnsuppress		Fail.PCmd_Unsuppress		When Cfg_PCmdClear is 0: <ul style="list-style-type: none"> Set PCmd_<Alarm>Suppress to 1 to suppress alarm Set PCmd_<Alarm>Suppress to 0 to unsuppress alarm PCmd_<Alarm>Unsuppress is not used These Parameters do not reset automatically
PCmd_FailUnshelve		Fail.PCmd_Unshelve		<ul style="list-style-type: none"> Set PCmd_<Alarm>Unshelve to 1 to Unshelve alarm The parameter is reset automatically
PCmd_Reset	BOOL		0	<ul style="list-style-type: none"> Set PCmd_Reset to 1 to reset all alarms requiring reset This parameter is always reset automatically
OCmd_Reset	BOOL		0	Operator command to reset all alarms requiring reset.
OCmd_ResetAckAll				Operator command to acknowledge and reset all alarms.

Analog Input Channel Output Structure

Output parameters include the following:

- Value data elements (Val_) are numeric outputs of the instruction for use by the HMI. Values also can be used by other application logic or software packages.
- Source and Quality data elements (SrcQ_) are outputs of the instruction used by the HMI to indicate PV source and quality.
- Status data elements (Sts_) are bit outputs of the instruction for use by the HMI. Status bits also can be used by other application logic.
- Error data elements (Err_) are outputs of the instruction that indicate a particular configuration error. If any Err_bit is set, then the Sts_Err configuration error summary status is set and the Invalid Configuration indicator is displayed on the HMI.

- Alarm data elements (Alm_) are outputs of the instruction that indicate a particular alarm has occurred.
- Acknowledge data elements (Ack_) are outputs of the instruction that indicate the corresponding alarm has been acknowledged.
- Ready data elements (Rdy_) are bit outputs of the instruction used by the HMI to enable or disable Command buttons and Setting entry fields.

Table 8 - P_AIChan Output Parameters

Output Parameter	Data Type	Alias For	Description
EnableOut	BOOL		Enable Output: The EnableOut signal is not manipulated by this instruction. Its output state always reflects EnableIn Input state.
Val_InpRaw	REAL		Analog input value (raw units) (before scaling or checking).
Val			PV value (engineering units).
Val_PVEUMin			Minimum of scaled range = minimum (Cfg_PVEUMin, Cfg_PVEUMax).
Val_PVEUMax			Maximum of scaled range = maximum (Cfg_PVEUMin, Cfg_PVEUMax).
SrcQ_IO	SINT		I/O signal source and quality.
SrcQ			Final channel status source and quality. GOOD 0 = I/O live and confirmed good quality 1 = I/O live and assumed good quality 2 = No feedback configured, assumed good quality TEST 8 = Device simulated 9 = Device loopback simulation 10 = Manually entered value UNCERTAIN 16 = Live input, off-specification 17 = Value substituted at device/bus 18 = Value substituted by maintenance (Has and not Use) 19 = Shed, using last good value 20 = Shed, using replacement value BAD 32 = Signal failure (out-of-range, NaN, invalid combination) 33 = I/O channel fault 34 = I/O module fault 35 = Bad I/O configuration (for example, scaling parameters)
Val_Sts	SINT		Device confirmed status: 0 = PV Good 5 = PV Uncertain 6 = PV Bad 7 = Substitute PV 33 = Disabled
Val_Fault	SINT		Device fault status: 0 = none 32 = Fail 34 = Configuration error
Val_Notify	SINT		Current alarm level and acknowledgement (enumeration): 0 = No alarm 1 = Alarm cleared: a reset or acknowledge is required 2 = Low (acknowledged) 3 = Low (unacknowledged) 4 = Medium (acknowledged) 5 = Medium (unacknowledged) 6 = High (acknowledged) 7 = High (unacknowledged) 8 = Urgent (acknowledged) 9 = Urgent (unacknowledged)

Table 8 - P_AIChan Output Parameters

Output Parameter	Data Type	Alias For	Description
Sts_PVGood	BOOL		1 = PV quality is Good (not flagged as Bad or Uncertain).
Sts_PVUncertain	BOOL		1 = PV quality is flagged as Uncertain.
Sts_PVBad	BOOL		1 = PV quality is flagged as Bad.
Sts_Uselnp	BOOL		1 = Using input to calculate PV (not replaced or held).
Sts_HoldLast	BOOL		1 = Analog PV being held at last good value.
Sts_Clamped	BOOL		1 = Analog PV being clamped at Low or High Limit.
Sts_Replaced	BOOL		1 = Analog PV being replaced with configured value.
Sts_InpOORHiCmp	BOOL		1 = Input PV exceeds out-of-range High limit.
Sts_InpOORLoCmp	BOOL		1 = Input PV exceeds out-of-range Low limit.
Sts_InpOutOfRange	BOOL		1 = Input is out-of-range (includes On-delay, deadband, Off-delay).
Sts_InpStuck	BOOL		1 = Input is 'stuck' (unchanging).
Sts_InpNaN	BOOL		1 = Input is not a number (floating point exception).
Sts_ModFault	BOOL		1 = I/O module fault condition.
Sts_ChanFault	BOOL		1 = I/O channel fault condition.
Sts_OutOfSpec	BOOL		1 = Working outside specifications (from instrument).
Sts_FuncCheck	BOOL		1 = Function check (PV simulated/replaced at instrument).
Sts_MaintReqd	BOOL		1 = Maintenance is required (from instrument).
Sts_Alminh	BOOL		1 = An alarm is inhibited, disabled, or shelved, display icon.
Sts_Err	BOOL		1 = Error in configuration (see detail Err_bits for reason), display icon.
Err_Raw	BOOL		1 = Error in configuration: raw input scaling minimum = maximum.
Err_EU	BOOL		1 = Error in configuration: scaled engineering units minimum = maximum.
Err_Timer	BOOL		1 = Error in timer preset (must be 0...2,147,483).
Err_DB	BOOL		1 = Error in configuration: a status deadband is < 0.0.
Err_Alarm	BOOL		1 = Error in configuration: alarm minimum on time, shelf time, or severity.
Sts_Fail	BOOL	Fail.Inp	1 = Analog input failure (Bad, Uncertain).
Alm_Fail	BOOL	Fail.Alm	1 = Analog input failure alarm (Bad, Uncertain).
Ack_Fail	BOOL	Fail.Ack	1 = Analog input failure alarm has been acknowledged.
Sts_FailDisabled	BOOL	Fail.Disabled	1 = Analog input failure alarm is disabled (by Maintenance).
Sts_FailSuppressed	BOOL	Fail.Suppressed	1 = Analog input failure alarm is suppressed (by Program).
Sts_FailShelved	BOOL	Fail.Shelved	1 = Analog input failure alarm is shelved (by Operator).
Rdy_Reset	BOOL		1 = At least one alarm requires reset.
Rdy_ResetAckAll	BOOL		1 = At least one alarm requires reset or acknowledgement.
P_AIChan	BOOL		Unique parameter name for auto-discovery.

Analog Input Channel Local Configuration Tags

Configuration parameters that are arrayed, string, or structure data types cannot be configured as parameters for Add-On Instructions. Configuration parameters of these types appear as local tags to the Add-On Instruction. Local tags can be configured through the HMI faceplates or in Studio 5000 Logix Designer® application by opening the instruction logic of the Add-On Instruction instance and then opening the Data Monitor on a local tag. These parameters cannot be modified by using controller logic or Logix Designer application export/import functionality.

Table 9 - Local Configuration Tags

Tag Name	Data Type	Default	Description
Cfg_Desc	STRING_40	'Analog Channel Quality'	Description for display on HMI. This string is shown in the title bar of the faceplate.
Cfg_EU	STRING_8	'%'	Engineering units for display on HMI.
Cfg_Label	STRING_20	'Analog In Channel'	Label for graphic symbol displayed on HMI. This string appears on the graphic symbol.
Cfg_RU	STRING_8	'mA DC'	Raw Units for display on HMI.
Cfg_Tag	STRING_20	'P_AIChan'	Tag name for display on HMI. This string is shown in the title bar of the faceplate.

Operations

This section describes the primary operations for Add-On Instructions.

Modes

The P_AIChan instruction does not have modes and does not use an embedded P_Mode Add-On Instruction. The P_AIChan instruction is used to monitor an analog input.

Alarms

This instruction uses the following alarms, which are implemented by using embedded P_Alarm and P_Gate Add-On Instructions.

Alarm Name	P_Alarm Name	P_Gate Name	Description
Fail	Fail	None	<p>Raised when the PV is flagged as Bad, or when the PV is flagged as Uncertain and Cfg_FailOnUncertain is 1. The PV can be configured to be flagged as Bad or Uncertain for the following reasons:</p> <ul style="list-style-type: none"> • Its value has not changed for more than the configured Stuck PV time • It is outside the configured failure range thresholds for more than the Out of Range on-delay time • It is infinite or not a number (floating point exception) • Module Fault input is true • Channel Fault input is true • Out of Specification (measurement uncertain) input is true • Function Check (PV substituted at device) input is true • Maintenance Required input is true • There is a Configuration Error (see Sts_Err and the Err_bits)

Parameters of the P_Alarm object can be accessed by using the following convention: [P_Alarm Name].[P_Alarm Parameter].

See Rockwell Automation Library of Process Objects: Common Alarm Block (P_Alarm) Reference Manual, publication [SYSLIB-RM002](#), for more information.

TIP

The P_AIChan object's 'Fail' alarm is set to not exist by default. If you set this alarm to exist, be aware that the P_AIChan object does not have its own display elements. Thus, you do not have a graphic symbol with flashing border to show and click to call up the P_AIChan faceplate. However, you can still get to the P_AIChan instance's faceplate easily when it raises a failure alarm in two different ways:

- Tie the Sts_PVBad output parameter of the P_AIChan instance to the Inp_PVBad input parameter of the downstream object and enable that object's I/O failure alarm. Enable the downstream object's navigation to its upstream Channel object. When the P_AIChan raises its Fail alarm, the symbol for the downstream object flashes. Call up the downstream object's faceplate, then navigate from there to the P_AIChan faceplate.
- In the FactoryTalk Alarm and Events alarm setup, create a command string for the P_AIChan 'Fail' alarm that opens the P_AIChan faceplate with that instance's tag. Instructions for how to do this are included in the alarm set-up PDF document that is included in the Rockwell Automation Library download. When the alarm occurs, open the Alarm Summary screen. Double-click the alarm in the summary list and the P_AIChan faceplate is displayed.

Simulation

The Analog Input Channel Add-On Instruction does not have a Simulation capability.

Execution

The following table explains the handling of instruction execution conditions.

Table 10 - P_AIChan Execution

Condition	Description
EnableIn False (false rung)	Clear any received commands. Reset internal timers. Clear the Fail alarm. Flag input quality as 'bad'. Show alarm inhibited status as disabled. Other parameters are left in their last state.
Powerup (prescan, first scan)	Reset internal timers. Clear any received commands.
Postscan (SFC Transition)	No SFC postscan logic is provided.

Refer to the Logix5000 Controllers Add-On Instructions Programming Manual, publication [1756-PM010](#), for more information.

Programming Example

The following example provides shows the connection from raw analog input through process value by using the P_AIChan block.

The raw input value (Local:1:I.Ch0Data) from the analog input card is used as the raw input value (Inp_Raw) for the P_AIChan block. The output value (Val) and quality (SrcQ) from the P_AIChan block are used as inputs for the P_AIn block. In this configuration, the P_AIn block uses the Cfg_HasChanObj configuration parameter. The final output process value (Feedwater_Flow) is the fully converted, scaled, and filtered analog value that is propagated through the system.

The P_AIChan block also uses the Channel Fault and Module Fault parameters taken from the same analog input module as the process value. Inp_Ch0Fault is simply the tag value for the channel (Local:1:I.Ch0Fault). The Inp_ModFault parameter (Rack1Slot4ModFault) is generated by using a GSV to the module object (with the instance for the appropriate card and then the EntryStatus parameter). The top four bits of the EntryStatus parameter are checked to make sure they do not equal 2#0100_xxxx_xxxx_xxxx. The 0100 pattern indicates the connection is "Running". All other values are considered faulted.

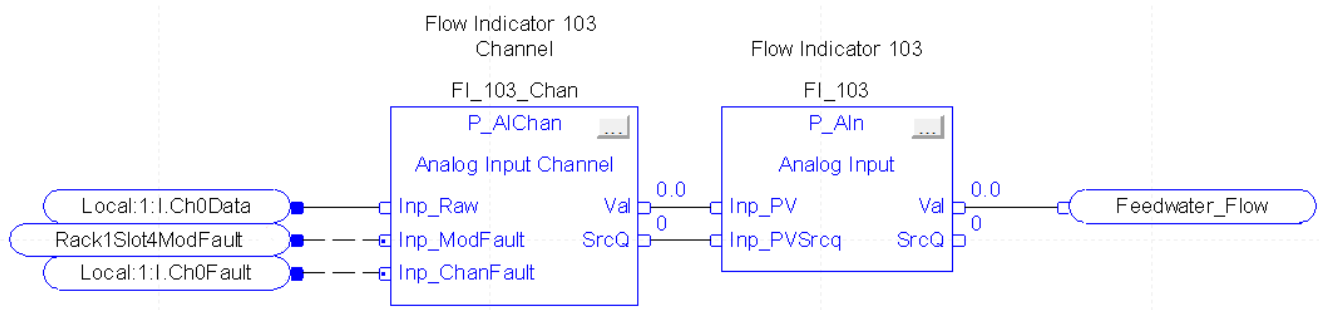









Display Elements

The P_AIChan instruction is used in association with other device instructions to provide input monitoring functions. There are no dedicated display elements for this instruction. The faceplate is called from the associated instruction's faceplate.

Status/Quality Indicators

One of these symbols appears on the graphic symbol when the described condition is true.

Graphic Symbol	Description
	Invalid configuration.
	Data quality bad/failure.
	Data Quality degraded: uncertain, test, simulation, substitution, or out of specification.
	The input or device has been disabled.
	Input Value clamped to minimum/maximum.
	Value infinite or not a number.
	Value has not changed (stuck).
	Value is being replaced.
	Value is being held at last good value.
No symbol displayed	I/O communication and quality good, configuration valid.



TIP When the Invalid Configuration indicator appears, you can find what configuration setting is invalid by following the indicators. The Invalid Configuration indicator appears next to the appropriate tab at the top of the faceplate to guide you in finding the configuration error. Once you navigate to the tab, the misconfigured item is flagged with this indicator or appears in a magenta box.

For the P_AIChan instruction, the Invalid Configuration indicator appears under any of the following conditions:

- Input raw minimum and maximum scaling parameters are set to the same value.
- Scaled EU minimum and EU maximum scaling parameters are set to the same value.
- The Out-of-range On-delay timer or the Out-of-range Off-delay timer is set to a value less than or greater than 2,147,483 seconds.
- The Stuck value timer is set to a value less than zero or greater than 2,147,483 seconds.
- Alarm Minimum On Time or Shelf Time is set to a value less than zero or greater than 2,147,483 seconds.
- Alarm Severity is set to a value less than 1 or greater than 1000.
- A deadband is set to a value less than zero.







Threshold Indicators

These indicators show that the PV has exceeded a threshold.

Graphic Symbol	Description
	High threshold exceeded
	Low threshold exceeded

Alarm Indicators

One of these symbols appears on the left of the label to indicate the described alarm condition. The alarm border and label background blink if Acknowledgement of an alarm condition is required. Once the alarm is acknowledged, the alarm border and label background remain the color that corresponds to the severity of the alarm.

Symbol	Border and Label Background	Description
	No change in color	Alarm Inhibit: an alarm is suppressed by the Program, disabled by Maintenance, or shelved by the Operator.
	White	Return to normal (no alarm condition), but a previous alarm has not been acknowledged.
	Blue	Low severity alarm.
	Yellow	Medium severity alarm.
	Red	High severity alarm.
	Magenta	Urgent severity alarm.
No symbol	No change in color	No alarm or alarm inhibit condition, and all alarms are acknowledged.

See Rockwell Automation Library of Process Objects: Common Alarm Block (P_Alarm) Reference Manual, publication [SYSLIB-RM002](#), for more information.

Faceplate

The P_AIChan faceplate consists of four tabs and each tab consists of one or more pages.

The title bar of each faceplate contains the value of local configuration tags Cfg_Tag and Cfg_Desc.

Tag - Description

The Operator tab is displayed when the faceplate is initially opened.

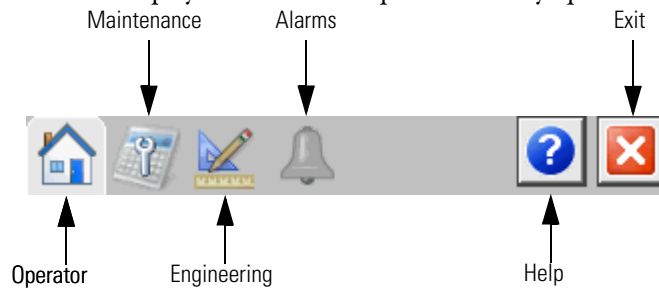

The faceplate provides the means for operators, maintenance personnel, engineers, and others to interact with the P_AIChan instruction instance. When a given input is restricted via Factory Talk View security, the required user security code letter is shown in the tables.

Operator Tab

The faceplate initially opens to the Operator ('Home') tab. From here, an operator can monitor the device status.

The Operator tab shows the following information:

- Current PV value in raw and engineering units
- PV status
- Input Source and Quality indicator (see 'SrcQ' in the Output parameters table on [page 14](#) for details)

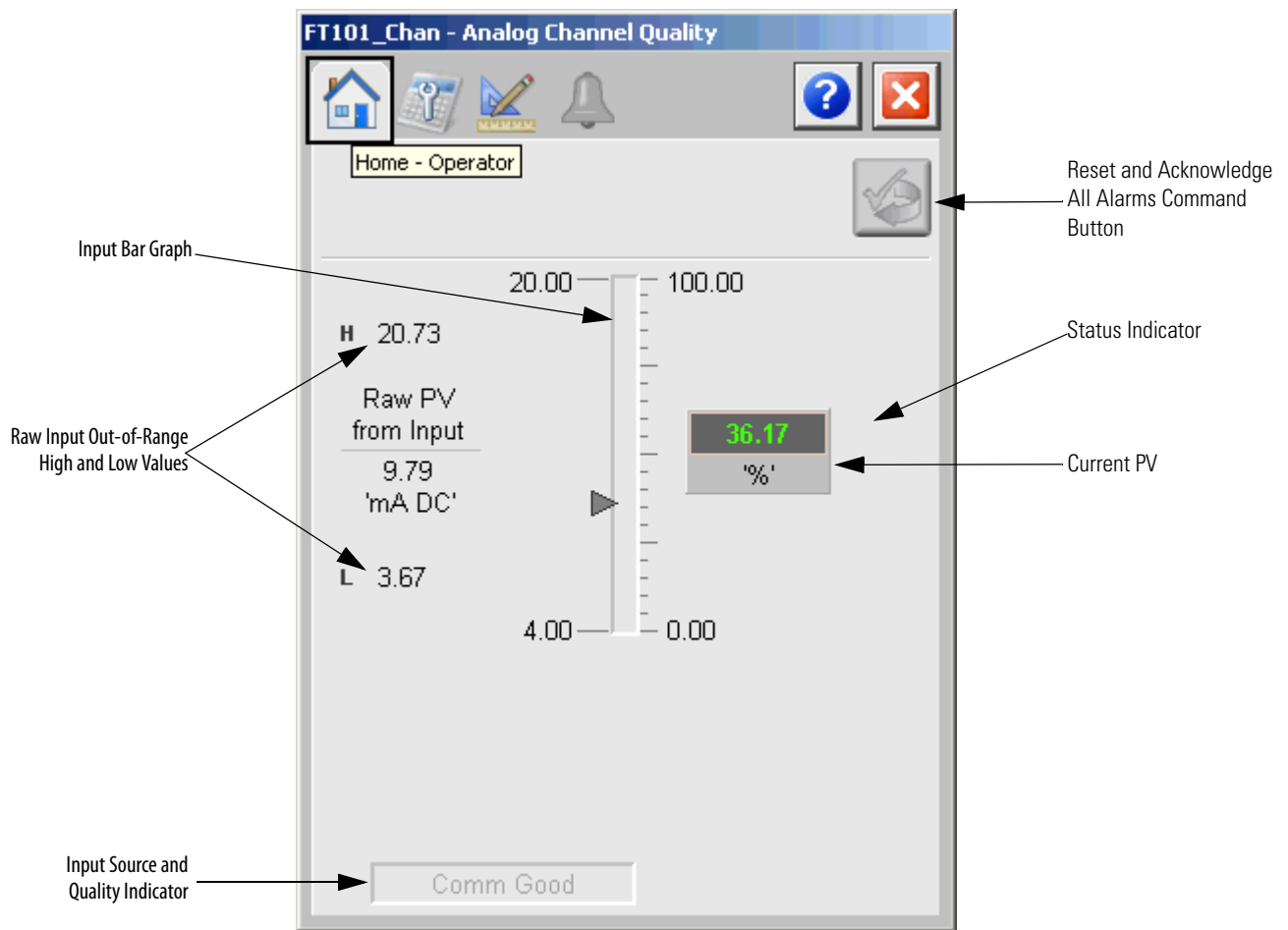

The following table lists the functions on the Operator tab.

Table 11 - Operator Tab Descriptions





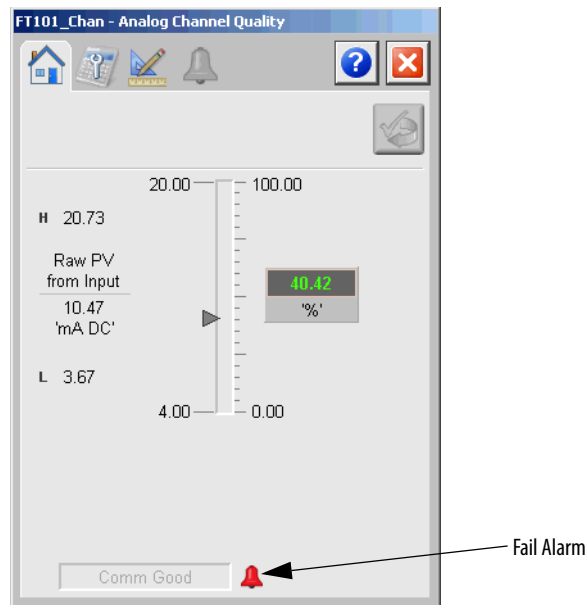

Function	Action	Security Required
	Click to reset and acknowledge all alarms.	Acknowledge Alarms (Code F)

An Alarm indicator appears on the Operator tab when the corresponding alarm occurs.



The following table shows the alarm status symbols used on the Operator tab.

Table 12 - Operator Tab Alarm Status

Graphic Symbol	Alarm Status
	In Alarm (Active Alarm)
	In Alarm and Acknowledged
	Out of Alarm but not Acknowledged
	Alarm Suppressed (by Program)
	Alarm Disabled (by Maintenance)
	Alarm Shelved (by Operator)

Maintenance Tab

Maintenance personnel use the information and controls on the Maintenance tab to make adjustments to device parameters.

The following table shows the functions on the Maintenance tab.

Table 13 - Maintenance Tab Descriptions

Function	Action	Security	Configuration Parameters
Value (EU) to use to replace PV when Action = Replace	Type the value to output as the PV when a condition occurs that has its action set to 'Replace'.	Configuration & Tuning Maintenance (Code D)	Cfg_PVReplaceVal
Minimum time In Range to clear Out of Range Status (seconds)	Type the amount of time the input must stay within the range thresholds (with deadband) to clear the Out of Range (fail) condition. The off-delay time is used to prevent a chattering fail detection on a noisy signal near a range threshold.		Cfg_Inp00ROffDly
Minimum time Out of Range to raise Status (seconds)	Type the amount of time the input must stay beyond a range threshold to cause an Out of Range (fail) condition. The on-delay time is used to avoid an unnecessary fail detection when the input only momentarily exceeds the threshold.		Cfg_Inp00ROnDly

Table 13 - Maintenance Tab Descriptions

Function	Action	Security	Configuration Parameters
Time with no change in Input to raise Stuck Status	Type the amount of time the input must remain unchanged to trigger a stuck input condition. A value of zero means the input must change every instruction scan to avoid a stuck input condition. Type a large value to disable stuck input detection.	Configuration & Tuning Maintenance (Code D)	Cfg_StuckT
Input Out of Range (Fail): Threshold Maximum and Minimum	Type the thresholds that are considered out of range (failed). If the PV is greater than or equal to the high threshold, or less than or equal to the low threshold for the on-delay time, it is considered out of range.	Disable Alarms Bypass Permissives and Interlocks (Code H)	<ul style="list-style-type: none"> • Cfg_InpOORHiLim • Cfg_InpOORLoLim
Input Out of Range (Fail): Deadband	Type the deadband to use with the out-of-range thresholds. If the PV is less than the high threshold minus the deadband and the PV is greater than the low threshold plus the deadband for the off-delay time, it is considered in range (not failed). The deadband must be greater than or equal to zero.		Cfg_InpOORDB
PV Clamping Limits (EU): Low	Type the low clamping limit for the PV. This clamps (limits) the PV so it does not go below this value. IMPORTANT: Out-of-Range detection uses the PV value before clamping. This entry does not affect Out-of-Range detection.	Configuration & Tuning Maintenance (Code D)	Cfg_PVLoLim
PV Clamping Limits (EU): High	Type the high clamping limit for the PV. This clamps (limits) the PV so it does not exceed this value. IMPORTANT: Out-of-Range detection uses the PV value before clamping. This entry does not affect Out-of-Range detection.		Cfg_PVHiLim

Engineering Tab

The Engineering tab provides access to device configuration parameters and ranges, options for device and I/O setup, displayed text, and faceplate-to-faceplate navigation settings, for initial system commissioning or later system changes.

The Engineering tab is divided into two pages.

Engineering Tab Page 1

On Page 1 of the Engineering tab, you can configure the description, label, tag, and PV units for the device.

The screenshot shows the configuration window for 'FT101_Chan - Analog Channel Quality'. The window has a title bar with a home icon, a calculator icon, a pencil icon, a bell icon, a help icon, and a close icon. Below the title bar are two tabs labeled '1' and '2', with 'Engineering' written above them. The main content area is divided into sections:

- Analog Channel Quality**: A dashed box containing the label 'Analog In Channel' and the tag 'FT101_Chan'. A bracket on the right points to this section with the text 'Configure Device Description, Label, and Tag'.
- Raw Input Scaling**: A section with two columns: 'Input' and 'Scaled'.

	Input		Scaled
Maximum	20.00	→ $f(x)$ →	100.00
Minimum	4.00		0.00
Units	'mA DC'		'%'

 A bracket on the left points to the Input Maximum/Minimum values with the text 'Configure Raw Input Maximum/Minimum'. A bracket on the right points to the Scaled Maximum/Minimum values with the text 'Configure Scaled Input Maximum/Minimum'. An arrow on the right points to the Units field with the text 'Raw and Scaled Units'.
- At the bottom, there are two checkboxes:
 - Fail if Bad or Uncertain quality (unchecked will fail on Bad quality)
 - Clear Program commands upon receipt

The following table lists the functions on page 1 of the Engineering tab.

Table 14 - Engineering Tab Page 1 Description

Function	Action	Security	Configuration Parameters
Description	Type the device description to show on the Faceplate title bar.	Engineering Configuration (Code E)	Cfg_Desc
Label	Type the label to show on the graphic symbol.		Cfg_Label
Tag	Type the tag name to show on the faceplate title bar and in the Tooltip. IMPORTANT: Pausing the mouse over this field displays a tool tip with the configured Logix tag/path.		Cfg_Tag
Raw Input Scaling: Input - Maximum	Type the range of the signal connected to the Inp_PV Input. The Raw Min default is 4.0 and the Raw Max default is 20.0. EXAMPLE: If your input card provides a signal from 4.0...20.0 mA, set Cfg_InpRawMin to 4.0 and Cfg_InpRawMax to 20.0. The Raw minimum/maximum and engineering units minimum/maximum are used for scaling to engineering units.		<ul style="list-style-type: none"> • Cfg_InpRawMax • Cfg_InpRawMin
Raw Input Scaling: Input - Minimum			
Raw Input Scaling: Scaled - Maximum	Type the PV range represented by the input signal connected to Inp_PV. The PV engineering units minimum default is 0.0 and the PV engineering units maximum is 100.0. EXAMPLE: If your input card provides a signal from 4...20 mA that represents -50...250 °C, set Cfg_PVEUMin to -50.0 and Cfg_PVEUMax to 250.0. The Raw Min/Max and PV engineering units Min/Max are used for scaling to Engineering Units.		<ul style="list-style-type: none"> • Cfg_PVEUMax • Cfg_PVEUMin
Raw Input Scaling: Scaled - Minimum			
Input Units	Type the units of measure for the input signal. "mA DC" is the default.		Cfg_RU
Scaled Units	Type the engineering units for display on the HMI. Percent (%) is the default.		Cfg_EU
Fail if Bad or Uncertain quality (unchecked will fail on Bad quality)	Check to trigger a failure condition and alarm when the PV status is either Bad or Uncertain. Clear this checkbox to trigger the failure condition when only the PV status is Bad.		Cfg_FailOnUncertain
Clear Program Commands upon receipt	Check to clear program commands on receipt.	Cfg_PCmDClear	

Engineering Tab Page 2

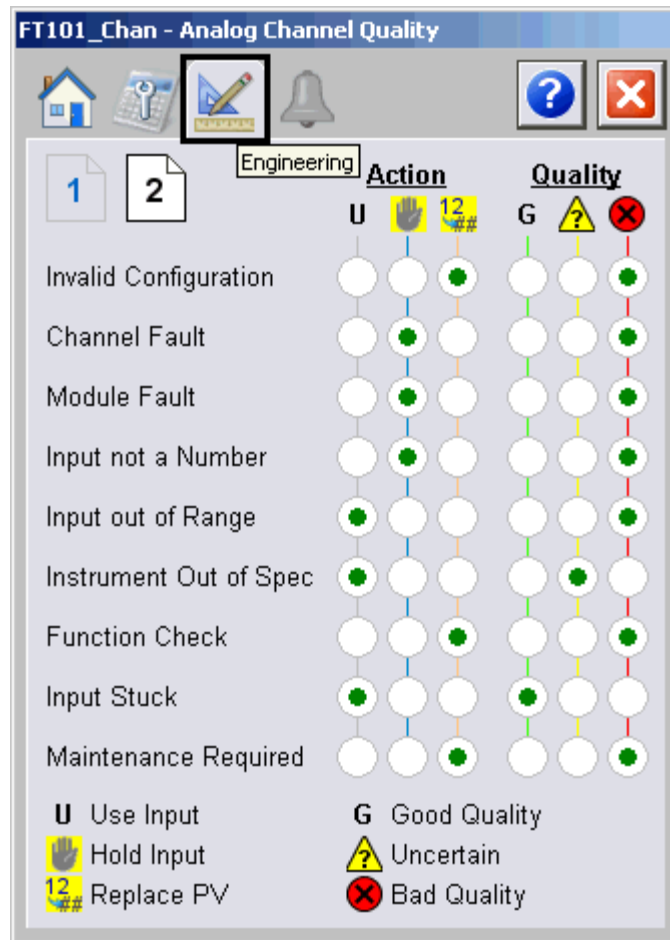

The following table shows the functions on page 2 of the Engineering tab.

Table 15 - Engineering Tab Page 2 Description

Function	Action	Security	Configuration Parameters
Invalid Configuration - Action = Use Input, Hold Input, or Replace PV	When the P_AIChan configuration is not valid: <ul style="list-style-type: none"> Use the input to determine value Hold value at its last good value Set value by using Cfg_PVReplaceVal 	Engineering Configuration (Code E)	Cfg_CfgErrAction
Invalid Configuration - Quality = Good Quality, Uncertain, or Bad Quality	When the P_AIChan configuration is not valid: <ul style="list-style-type: none"> Set Sts_PVGood Set Sts_PVUncertain Set Sts_PVBad 		Cfg_CfgErrQual
Channel Fault- Action = Use Input, Hold Input, or Replace PV	When there is a channel fault: <ul style="list-style-type: none"> Use the input to determine value Hold value at its last good value Set value by using Cfg_PVReplaceVal 		Cfg_ChanFaultAction

Table 15 - Engineering Tab Page 2 Description

Function	Action	Security	Configuration Parameters
Channel Fault - Quality = Good, Uncertain, or Bad Quality	When there is a channel fault: <ul style="list-style-type: none"> • Set Sts_PVGood • Set Sts_PVUncertain • Set Sts_PVBad 	Engineering Configuration (Code E)	Cfg_ChanelFaultQual
Module Fault- Action = Use Input, Hold Input, or Replace PV	When there is a module fault: <ul style="list-style-type: none"> • Use the input to determine value • Hold value at its last good value • Set value by using Cfg_PVReplaceVal 		Cfg_ModFaultAction
Module Fault - Quality = Good, Uncertain, or Bad Quality	When there is a module fault: <ul style="list-style-type: none"> • Set Sts_PVGood • Set Sts_PVUncertain • Set Sts_PVBad 		Cfg_ModFaultQual
Input not a Number - Action = Use Input, Hold Input, or Replace PV	When the input is not a number: <ul style="list-style-type: none"> • Use the input to determine value • Hold value at its last good value • Set value by using Cfg_PVReplaceVal 		Cfg_InpNaNAction
Input not a Number - Quality = Good, Uncertain, or Bad Quality	When the input is not a number: <ul style="list-style-type: none"> • Set Sts_PVGood • Set Sts_PVUncertain • Set Sts_PVBad 		Cfg_InpNaNQual
Input out of Range- Action = Use Input, Hold Input, or Replace PV	When the input is out of range: <ul style="list-style-type: none"> • Use the input to determine value • Hold value at its last good value • Set value by using Cfg_PVReplaceVal 		Cfg_InpOORAction
Input out of Range- Quality = Good, Uncertain, or Bad Quality	When the input is out of range: <ul style="list-style-type: none"> • Set Sts_PVGood • Set Sts_PVUncertain • Set Sts_PVBad 		Cfg_InpOORQual
Function Check - Action = Use Input, Hold Input, or Replace PV	When Inp_FuncCheck is set: <ul style="list-style-type: none"> • Use the input to determine value • Hold value at its last good value • Set value by using Cfg_PVReplaceVal 		Cfg_FuncCheckAction
Function Check - Quality = Good, Uncertain, or Bad Quality	When Inp_FuncCheck is set: <ul style="list-style-type: none"> • Set Sts_PVGood • Set Sts_PVUncertain • Set Sts_PVBad 		Cfg_FuncCheckQual
Input Stuck - Action = Use Input, Hold Input, or Replace PV	When the input is stuck (not changing): <ul style="list-style-type: none"> • Use the input to determine value • Hold value at its last good value • Set value by using Cfg_PVReplaceVal 		Cfg_InpStuckAction

Table 15 - Engineering Tab Page 2 Description

Function	Action	Security	Configuration Parameters
Input Stuck - Quality = Good Quality, Uncertain, or Bad Quality	When the input is stuck (not changing): <ul style="list-style-type: none"> • Set Sts_PVGood • Set Sts_PVUncertain • Set Sts_PVBad 	Engineering Configuration (Code E)	Cfg_InpStuckQual
Maintenance Required - Action = Use Input, Hold Input, or Replace PV	When Inp_MaintReqd is set: <ul style="list-style-type: none"> • Use the input to determine value • Hold value at its last good value • Set value by using Cfg_PVReplaceVal 		Cfg_MaintReqdAction
Maintenance Required - Quality = Good Quality, Uncertain, or Bad Quality	When Inp_MaintReqd is set: <ul style="list-style-type: none"> • Set Sts_PVGood • Set Sts_PVUncertain • Set Sts_PVBad 		Cfg_MaintReqdQual

Alarms Tab

The Alarms tab displays each configured alarm for the P_AIChan instruction. The icon on the tab for the alarms page changes color based on the current active alarms. A blinking alarm icon indicates that one or more alarms must be acknowledged or the device must be reset.

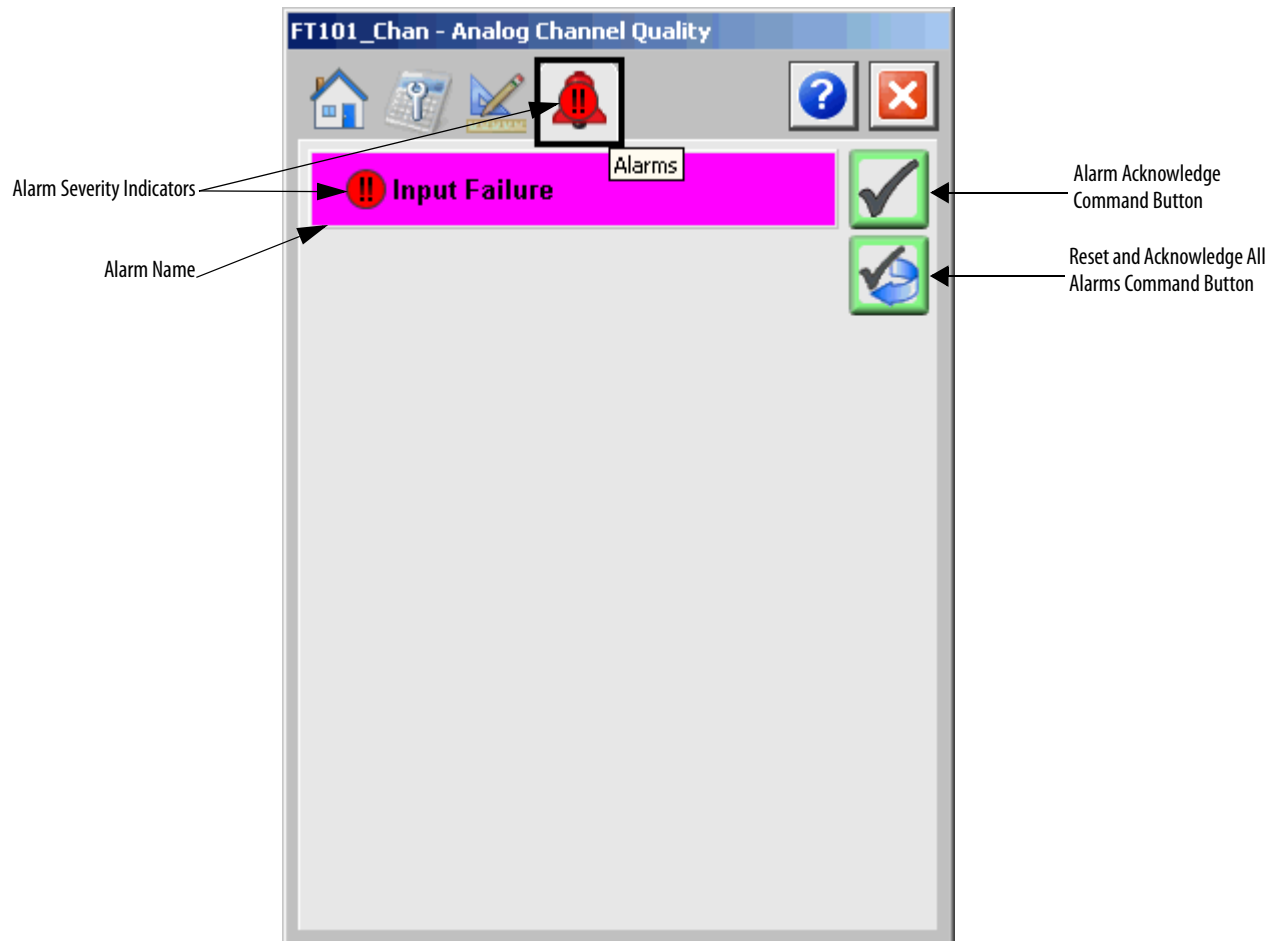

Click an alarm name to open the P_Alarm faceplate for that alarm. From the P_Alarm faceplate, you can configure and perform additional operations on the alarm.



If an alarm is active, the panel behind the alarm changes color to match the severity of the alarm. The color of the bell icon at the top of the faceplate shows the severity of the highest active alarm, and the icon blinks if any alarm is unacknowledged or requires reset.

Table 16 - Alarm Severity Colors

Color	Definition
Magenta	Urgent
Red	High
Yellow	Medium
Blue	Low
White (bell icon)	Alarm has cleared but is unacknowledged
Background (Light Gray)	No alarm

The following table shows the functions on the Alarms tab.

Table 17 - Alarms Tab Description

Function	Action	Security
Alarm Name	Click an alarm name to open the associated P_Alarm faceplate.	None
	Click to acknowledge the alarm.	Acknowledge Alarms (Code F)
	Click to reset and acknowledge all alarms.	

When the Reset and Acknowledge All Alarms button is enabled, the panel behind the alarm blinks, indicating the alarm requires acknowledgement or reset. The Alarm Acknowledge button is enabled if the alarm requires acknowledgment. Click the button with the check mark to acknowledge the alarm.













See Rockwell Automation Library of Process Objects: Common Alarm Block (P_Alarm) Reference Manual, publication [SYSLIB-RM002](#), for more information.

Analog Input Channel Faceplate Help





Faceplate Help

✕
Analog Input Channel Faceplate Help

Status Indicators

<ul style="list-style-type: none">  Invalid Configuration  Communication Failure  Communication Uncertain  Input has been Disabled  Value Infinite or Not a Number  Value is being Held at last good value 	<ul style="list-style-type: none">  Alarm Inhibit (Suppressed or Disabled)  Maintenance Bypass Active  Device in Simulation or Test  Value Clamped to min/max  Value has not changed (Stuck)  Value is being replaced
--	---

Level Indicators

<ul style="list-style-type: none">  High-High Level Exceeded  High Level Exceeded 	<ul style="list-style-type: none">  Low-Low Level Exceeded  Low Level Exceeded
---	--

Alarms

?

Device Fail Alarm

This alarm triggers when the Raw Process Value remains above the Out of Range High limit or below the Out of Range Low limit for a specified period of time. The Alarm also triggers when the input PV signal quality is bad.

Rockwell Automation Support

Rockwell Automation provides technical information on the Web to assist you in using its products.

At <http://www.rockwellautomation.com/support> you can find technical and application notes, sample code, and links to software service packs. You can also visit our Support Center at <https://rockwellautomation.custhelp.com/> for software updates, support chats and forums, technical information, FAQs, and to sign up for product notification updates.

In addition, we offer multiple support programs for installation, configuration, and troubleshooting. For more information, contact your local distributor or Rockwell Automation representative, or visit <http://www.rockwellautomation.com/services/online-phone>.

Installation Assistance

If you experience a problem within the first 24 hours of installation, review the information that is contained in this manual. You can contact Customer Support for initial help in getting your product up and running.

United States or Canada	1.440.646.3434
Outside United States or Canada	Use the Worldwide Locator at http://www.rockwellautomation.com/rockwellautomation/support/overview.page , or contact your local Rockwell Automation representative.

New Product Satisfaction Return

Rockwell Automation tests all of its products to help ensure that they are fully operational when shipped from the manufacturing facility. However, if your product is not functioning and needs to be returned, follow these procedures.

United States	Contact your distributor. You must provide a Customer Support case number (call the phone number above to obtain one) to your distributor to complete the return process.
Outside United States	Please contact your local Rockwell Automation representative for the return procedure.

Documentation Feedback

Your comments will help us serve your documentation needs better. If you have any suggestions on how to improve this document, complete this form, publication [RA-DU002](#), available at <http://www.rockwellautomation.com/literature/>.

Rockwell Automation maintains current product environmental information on its website at <http://www.rockwellautomation.com/rockwellautomation/about-us/sustainability-ethics/product-environmental-compliance.page>.

Rockwell Otomasyon Ticaret A.Ş., Kar Plaza İş Merkezi E Blok Kat:6 34752 İçerenköy, İstanbul, Tel: +90 (216) 5698400

www.rockwellautomation.com

Power, Control and Information Solutions Headquarters

Americas: Rockwell Automation, 1201 South Second Street, Milwaukee, WI 53204-2496 USA, Tel: (1) 414.382.2000, Fax: (1) 414.382.4444
Europe/Middle East/Africa: Rockwell Automation NV, Pegasus Park, De Kleetlaan 12a, 1831 Diegem, Belgium, Tel: (32) 2 663 0600, Fax: (32) 2 663 0640
Asia Pacific: Rockwell Automation, Level 14, Core F, Cyberport 3, 100 Cyberport Road, Hong Kong, Tel: (852) 2887 4788, Fax: (852) 2508 1846

Publication SYSLIB-RM042C-EN-P - January 2016

Supersedes Publication SYSLIB-RM042B-EN-P - August 2014

Copyright © 2016 Rockwell Automation, Inc. All rights reserved. Printed in the U.S.A.