

# Rockwell Automation Library of Process Objects: Mix-proof Valve (P\_ValveMP)

Version 3.5

**IMPORTANT**

This manual applies to the Rockwell Automation Library of Process Objects version 3.5 or earlier.  
For Rockwell Automation Library of Process Objects version 5.0, see

- [PROCES-RM200](#)

For Rockwell Automation Library of Process Objects version 4.0 or later, use the following manuals:

- [PROCES-RM013](#) contains logic instructions
- [PROCES-RM014](#) contains display elements



## Important User Information

Read this document and the documents listed in the additional resources section about installation, configuration, and operation of this equipment before you install, configure, operate, or maintain this product. Users are required to familiarize themselves with installation and wiring instructions in addition to requirements of all applicable codes, laws, and standards.

Activities including installation, adjustments, putting into service, use, assembly, disassembly, and maintenance are required to be carried out by suitably trained personnel in accordance with applicable code of practice.

If this equipment is used in a manner not specified by the manufacturer, the protection provided by the equipment may be impaired.

In no event will Rockwell Automation, Inc. be responsible or liable for indirect or consequential damages resulting from the use or application of this equipment.

The examples and diagrams in this manual are included solely for illustrative purposes. Because of the many variables and requirements associated with any particular installation, Rockwell Automation, Inc. cannot assume responsibility or liability for actual use based on the examples and diagrams.

No patent liability is assumed by Rockwell Automation, Inc. with respect to use of information, circuits, equipment, or software described in this manual.

Reproduction of the contents of this manual, in whole or in part, without written permission of Rockwell Automation, Inc., is prohibited.

Throughout this manual, when necessary, we use notes to make you aware of safety considerations.



**WARNING:** Identifies information about practices or circumstances that can cause an explosion in a hazardous environment, which may lead to personal injury or death, property damage, or economic loss.



**ATTENTION:** Identifies information about practices or circumstances that can lead to personal injury or death, property damage, or economic loss. Attentions help you identify a hazard, avoid a hazard, and recognize the consequence.

---

### IMPORTANT

Identifies information that is critical for successful application and understanding of the product.

---

Labels may also be on or inside the equipment to provide specific precautions.



**SHOCK HAZARD:** Labels may be on or inside the equipment, for example, a drive or motor, to alert people that dangerous voltage may be present.



**BURN HAZARD:** Labels may be on or inside the equipment, for example, a drive or motor, to alert people that surfaces may reach dangerous temperatures.



**ARC FLASH HAZARD:** Labels may be on or inside the equipment, for example, a motor control center, to alert people to potential Arc Flash. Arc Flash will cause severe injury or death. Wear proper Personal Protective Equipment (PPE). Follow ALL Regulatory requirements for safe work practices and for Personal Protective Equipment (PPE).

---

---

<b>Preface</b>	Software Compatibility and Content Revision . . . . .	5
	Additional Resources . . . . .	5
<b>Mix-proof Valve (P_ValveMP)</b>	Guidelines . . . . .	7
	Functional Description . . . . .	8
	Required Files . . . . .	9
	Controller File . . . . .	9
	Visualization Files . . . . .	9
	Controller Code . . . . .	12
	Mix-proof Valve Input Structure . . . . .	12
	Mix-proof Valve Output Structure . . . . .	16
	Mix-proof Valve Local Configuration Tags . . . . .	21
	Operations . . . . .	22
	Modes . . . . .	22
	Alarms . . . . .	23
	Simulation . . . . .	23
	Execution . . . . .	24
	Programming Example . . . . .	25
	Display Elements . . . . .	28
	State Indicators . . . . .	30
	Status/Quality Indicators . . . . .	30
	Mode Indicators . . . . .	31
	Alarm Indicators . . . . .	32
	Maintenance Bypass Indicator . . . . .	33
	Using Display Elements . . . . .	34
	Quick Display . . . . .	36
	Faceplate . . . . .	36
	Operator Tab . . . . .	37
	Maintenance Tab . . . . .	42
	Engineering Tab . . . . .	44
	Diagnostics Tab . . . . .	51
	Alarms Tab . . . . .	52
	Mix-proof Valve Faceplate Help . . . . .	54

**Notes:**

## Software Compatibility and Content Revision

**Table 1 - Summary of Changes**

Topic	Page
Visualization Files: Global Objects (.ggfx) - Process Diagnostic Objects	10

For the latest compatible software information and to download the Rockwell Automation® Library of Process Objects, see the Product Compatibility and Download Center at <http://www.rockwellautomation.com/rockwellautomation/support/pcdc.page>.

For general library considerations, see Rockwell Automation Library of Process Objects, publication [PROCES-RM002](#).

## Additional Resources

These documents contain additional information concerning related products from Rockwell Automation.

Resource	Description
PlantPAx® Distributed Control System Selection Guide, publication <a href="#">PROCES-SG001</a>	Provides information to assist with equipment procurement for your PlantPAx system.
PlantPAx Distributed Control System Reference Manual, publication <a href="#">PROCES-RM001</a>	Provides characterized recommendations for implementing your PlantPAx system.
Rockwell Automation Library of Process Objects, publication <a href="#">PROCES-RM002</a>	Provides general considerations for the PlantPAx system library of process objects.
FactoryTalk® View Machine Edition User Manual, publication <a href="#">VIEWME-UM004</a>	Provides details on how to use this software package for creating an automation application.
FactoryTalk View Site Edition User Manual, publication <a href="#">VIEWSE-UM006</a>	Provides details on how to use this software package for developing and running human-machine interface (HMI) applications that can involve multiple users and servers, distributed over a network.
Logix5000™ Controllers Add-On Instructions Programming Manual, publication <a href="#">1756-PM010</a>	Provides information for designing, configuring, and programming Add-On Instructions.
Rockwell Automation Library of Process Objects Common Alarm Block (P_Alarm) Reference Manual, publication <a href="#">SYSLIB-RM002</a>	Details how to monitor an input condition to raise an alarm. Information includes acknowledging, resetting, inhibiting, and disabling an alarm.
Rockwell Automation Library of Process Objects: Interlocks with First Out and Bypass (P_Intlk) Reference Manual, publication <a href="#">SYSLIB-RM004</a>	Explains how to collect (sum up) the interlock conditions that stop or de-energize a running or energized piece of equipment or prevent it from starting or being energized.
Rockwell Automation Library of Process Objects Common Mode Block (P_Mode) Reference Manual, publication <a href="#">SYSLIB-RM005</a>	Explains how to select the Mode (owner) of an instruction or control strategy. The Mode instruction is usually embedded within other instructions to extend their functionality. It is possible to use a standalone Mode instruction to enhance a program where modes are wanted.
Rockwell Automation Library of Process Objects: Permissives with Bypass (P_Perm) Reference Manual, publication <a href="#">SYSLIB-RM007</a>	Details how to collect permissive conditions to start a piece of equipment.
Rockwell Automation Library of Process Objects: 2-state Valve Statistics (P_ValveStats) Reference Manual, publication <a href="#">SYSLIB-RM036</a>	Explains how to monitor stroke times and stroke counts for a 2-state (open and close) valve.

You can view or download publications at <http://www.rockwellautomation.com/literature/>. To order paper copies of technical documentation, contact your local Allen-Bradley distributor or Rockwell Automation sales representative.

# Mix-proof Valve (P\_ValveMP)

The Mix-proof Valve (P\_ValveMP) Add-On Instruction controls one mix-proof valve in various modes and states, and can check position feedback inputs to verify that the valve reached the commanded position. An alarm can be provided on failure to reach a target position. The global objects and following faceplate are examples of the graphical interface tools for this Add-On Instruction.

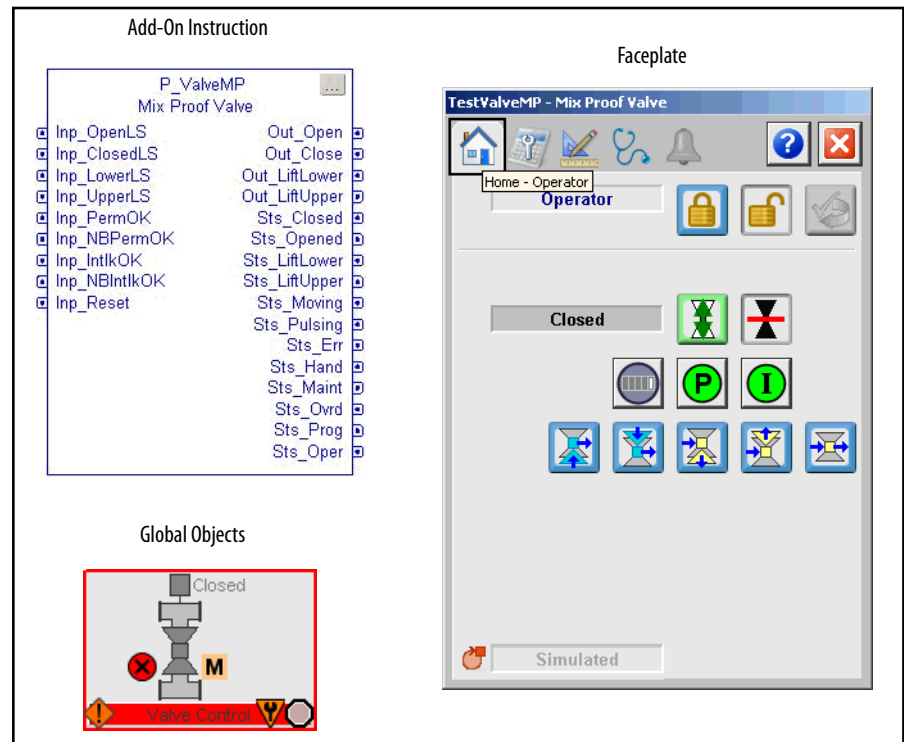

## Guidelines

Use this instruction if you want to operate a discrete mix-proof valve.

This instruction supports mix-proof valves with or without additional connections for cleaning (CIP, clean-in-place) or steaming (SIP, sanitize in place).

Do **not** use this instruction in these situations:

- You have some other type of open-close valve:
  - Use the P\_Valve SO instruction for a single solenoid-operated valve (single output with spring return to fail position).
  - Use the P\_ValveMO instruction for a motor-operated valve, or for a dual solenoid valve (separate open and close outputs).
  - Use the P\_ValveHO instruction for a hand-operated valve, which is a valve that is monitored only, or that has one output for tripping the valve to its failure position.

- You have a throttling (continuously variable) valve.

Use the P\_AOut (analog output) or P\_ValveC (control valve) instruction instead.

## Functional Description

The P\_ValveMP Add-On Instruction provides the following capabilities:

- Operates a mix-proof valve with the following positions:
  - Closed
  - Opened
  - Lift upper seat (optional)\*
  - Lift lower seat (optional)\*
  - CIP/SIP leakage cavity (optional)
  - CIP/SIP upper seat (optional)\*
  - CIP/SIP lower seat (optional)\*

The asterisk (\*) indicates that the position has an option to pulse the seat being cleaned or lifted opened and closed to provide enhanced cleaning. (As the seat is popped open and closed, the flow velocity across the seat is increased compared to the fully open seat position.) Pulse times are configurable

- Operated by using a state model that makes sure that valve seats are sequenced properly to avoid cross-contamination

See [page 49](#) for the valve state diagram

- Provides six outputs and six inputs. The outputs in each valve state (including intermediate states) are configurable for on and off states. The inputs that verify each valve state are configurable for their required on, required off, and don't care states. Provides feedback checking to make sure the valve reaches each position, including intermediate positions before moving to the next position. The time for feedback inputs to confirm each state is configurable
- Graphic symbols are provided for mix-proof valves in 2-D layouts and 3-D (isometric) layouts for ease in building valve array and routing manifold displays
- Provides inputs for Permissive conditions to enable moving the valve from the closed state
- Provides inputs for Interlock conditions to drive the valve to the closed state
- Monitors for I/O communication faults and closes the valve and alarms on a fault
- Provides an 'available' status for Program mode logic so automation code can know whether the valve can be controlled
- Provides a valve simulation capability. When the mix-proof valve is being simulated, outputs are left de-energized, and the instruction behaves as if a fully functioning valve were providing feedback



## Required Files

Add-On Instructions are reusable code objects that contain encapsulated logic that can streamline implementing your system. This lets you create your own instruction set for programming logic as a supplement to the instruction set provided natively in the ControlLogix® firmware. An Add-On Instruction is defined once in each controller project, and can be instantiated multiple times in your application code as needed.

## Controller File

The P\_ValveMP\_3\_5-00\_AOIL5X Add-On Instruction must be imported into the controller project to be used in the controller configuration. The service release number (boldfaced) can change as service revisions are created.

## Visualization Files

This Add-On Instruction has associated visualization files that provide a common user interface. These files can be downloaded from the Product Compatibility and Download Center at <http://www.rockwellautomation.com/rockwellautomation/support/pcdc.page>.

---

**IMPORTANT** The visualization file dependencies require Process Library content imports to occur in a specific order as reflected in the following tables:

- Images
  - Global Objects
  - Standard Displays
  - HMI Tags
  - Macros
- 

Images are external graphic files that can be used in displays. They must be imported for FactoryTalk View to make use of them.

When PNG files are imported, they are renamed by FactoryTalk View with a .bmp file extension, but retain a .png format.

**Table 2 - Visualization Files: Images (.png)**

FactoryTalk View SE Software	FactoryTalk View ME Software	Description
All .png files in the images folder	All .png files in the images folder	These are the common icons used in the global objects and standard displays for all Process Objects.

The Global Object files (.ggfx file type) in the following table are Process Library display elements that are created once and referenced multiple times on multiple displays in an application. When changes are made to a Global Object, all instances in the application are automatically updated.

**Table 3 - Visualization Files: Global Objects (.ggfx)**

FactoryTalk View SE Software	FactoryTalk View ME Software	Description
(RA-BAS) Common Faceplate Objects	(RA-BAS-ME) Common Faceplate Objects	Global objects used on process object faceplates.
(RA-BAS) P_ValveMP Graphics Library	(RA-BAS-ME) P_ValveMP Graphics Library	P_ValveMP global object device symbols used to build process graphics.

**Table 3 - Visualization Files: Global Objects (.ggfx)**

FactoryTalk View SE Software	FactoryTalk View ME Software	Description
(RA-BAS) Process Alarm Objects	(RA-BAS-ME) Process Alarm Objects	Global objects used for managing alarms on process object faceplates.
(RA-BAS) Process Diagnostic Objects	(RA-BAS-ME) Process Diagnostic Objects	Diagnostic global objects used on process object faceplates.
(RA-BAS) Process Faceplate Valve Objects	(RA-BAS-ME) Process Faceplate Valve Objects	Valve global objects used on process object faceplates
(RA-BAS) Process Graphics Library	(RA-BAS-ME) Process Graphics Library	Process global object device symbols used to build process graphics
(RA-BAS) Process Help Objects	(RA-BAS-ME) Process Help Objects	Global objects used for all process objects help displays.
(RA-BAS) Process Interlock Objects	(RA-BAS-ME) Process Interlock Objects	Global objects used for managing interlocks and permissives on process object faceplates.
(RA-BAS) Process Mode Objects	(RA-BAS-ME) Process Mode Objects	Global objects used for managing modes on process object faceplates.

The Standard Display files (.gfx file type) in the following table are the Process Library displays that you see at runtime.

**Table 4 - Visualization Files: Standard Displays (.gfx)**

FactoryTalk View SE Software	FactoryTalk View ME Software	Description
(RA-BAS) Common-AnalogEdit	N/A	Faceplate used for analog input data entry. The FactoryTalk View ME faceplates use the native analog input data entry so no file is required.
(RA-BAS) P_Alarm-Faceplate	(RA-BAS-ME) P_Alarm-Faceplate	The faceplate that is used for managing alarms for the object.
(RA-BAS) P_Alarm-Help	(RA-BAS-ME) P_Alarm-Help	Alarm Help information that is accessed from the P_Alarm faceplate.
(RA-BAS) P_Mode-Config	(RA-BAS-ME) P_Mode-Config	The Configuration Display used to configure the P_Mode object.
(RA-BAS) P_Mode-Help	(RA-BAS-ME) P_Mode-Help	Mode Help information that is accessed from the Help faceplate.
(RA-BAS) P_ValveMP-Config	(RA-BAS-ME) P_ValveMP-Config	The Configuration Display used to configure the P_ValveMP object.
(RA-BAS) P_ValveMP-Faceplate	(RA-BAS-ME) P_ValveMP-Faceplate	The faceplate that is used for the object
(RA-BAS) P_ValveMP-Quick	(RA-BAS-ME) P_ValveMP-Quick	The Quick display that is used for the object
(RA-BAS) Process Valve Family-Help	(RA-BAS-ME) Process Valve Family-Help	The Help display for Valve objects
(RA-BAS) P_Intlk-Faceplate	(RA-BAS-ME) P_Intlk-Faceplate	<b>Optional</b> The interlock faceplate used for the object. Use this file if your Discrete Output has an associated P_Intlk object and you enable navigation to its faceplate from the Discrete Output faceplate.
(RA-BAS) P_Perm-Faceplate	(RA-BAS-ME) P_Perm-Faceplate	<b>Optional</b> Permissive faceplate that is used for the object Use this file if your object has an associated P_Perm object and you enable navigation to the P_Perm faceplate from the object faceplate.
(RA-BAS) P_ValveStats-Faceplate	(RA-BAS-ME) P_ValveStats-Faceplate	<b>Optional</b> Valve statistics faceplate display that is used for the object Use this file if your object has an associated P_ValveStats object and you enable navigation to the P_ValveStats faceplate from the object faceplate.

**Table 4 - Visualization Files: Standard Displays (.gfx)**

FactoryTalk View SE Software	FactoryTalk View ME Software	Description
(RA-BAS) Process Interlock Family-Help	(RA-BAS-ME) Process Interlock Family-Help	<b>Optional</b> Interlock/permisives help display that is used for the object Use this file if you use the P_Intlk or P_Perm faceplate.

HMI Tags are created in a FactoryTalk View ME application to support tab switching on Process Library faceplates. The HMI tags may be imported via the comma-separated values file (.csv file type) in the following table.

**Table 5 - Visualization Files: HMI Tags (.csv)**

FactoryTalk View SE Software	FactoryTalk View ME Software	Description
N/A	FTVME_PlantPaxLib_Tags_3_5_XX.csv where XX = the service release number.	These tags must be imported into the FactoryTalk View ME project to support switching tabs on any Process Object faceplate.

## Controller Code

This section describes the parameter references for this Add-On Instruction.

### Mix-proof Valve Input Structure

Input parameters include the following:

- Input data elements (Inp\_) are typically used to connect field inputs from I/O modules or signals from other objects.
- Configuration data elements (Cfg\_) are used to set configurable capabilities and features of the instruction.
- Command data elements (PCmd\_, OCmd\_, MCmd\_) are used by program logic, operators, and maintenance personnel to request instruction actions.
- Setting data elements (PSet\_) are used by program logic to establish runtime setpoints, thresholds, and so forth.

**Table 6 - P\_ValveMP Input Parameters**

Input Parameter	Data Type	Alias For	Default	Description
EnableIn	BOOL		1	<p><b>Ladder Diagram:</b> If the rung-in condition is true, the instruction's Logic routine executes. If the rung-in condition is false, the instruction's EnableInFalse routine executes.</p> <p><b>Function Block Diagram:</b> If true, or not connected, the instruction's Logic routine executes. If the parameter is exposed as a pin and wired, and the pin is false, the instruction's EnableInFalse routine executes.</p> <p><b>Structured Text:</b> No effect. The instruction's Logic routine executes.</p>
Inp_OpenLS	BOOL		0	Valve open limit switch.
Inp_ClosedLS	BOOL		0	Valve closed limit switch.
Inp_LowerLS	BOOL		0	Valve Lower Seat Lift limit switch.
Inp_UpperLS	BOOL		0	Valve Upper Seat Lift limit switch.
Inp_CavityInLS	BOOL		0	Valve Cavity Inlet Valve limit switch.
Inp_CavityOutLS	BOOL		0	Valve Cavity Outlet Valve limit switch.
Inp_PermOK	BOOL		1	1 = Permissives OK, valve can energize.
Inp_NBPermOK	BOOL		1	1 = Non-bypassable Permissives OK, valve can energize.
Inp_IntlkOK	BOOL		1	1 = Interlocks OK, valve can energize or stay energized.
Inp_NBIntlkOK	BOOL		1	1 = Non-bypassable Interlocks OK, valve can energize or stay energized.
Inp_IOFault	BOOL		0	Input communication status: 0 = OK 1 = Fail
Inp_Sim	BOOL		0	0 = Open/close/monitor actual valve. 1 = Simulate working valve.
Inp_Hand	BOOL	Mode.Inp_Hand	0	1 = Select hand (hard-wired) mode.
Inp_Ovr	BOOL	Mode.Inp_Ovr	0	1 = Select Override mode.

Table 6 - P\_ValveMP Input Parameters

Input Parameter	Data Type	Alias For	Default	Description
Inp_OvrCmd	DINT		0	Override mode command: 0 = None 1 = Closed 2 = Open 3 = Lift lower 4 = Lift upper 5 = SIP/CIP cavity 6 = SIP/CIP lower seat 7 = SIP/CIP upper seat
Inp_Reset	BOOL		0	Input parameter used to programmatically reset alarms. When set to 1, all alarms requiring reset are reset.
Cfg_HasLiftLower	BOOL		1	1 = Valve supports Lift Lower Seat State (4).
Cfg_HasLiftUpper	BOOL		1	1 = Valve supports Lift Upper Seat State (5).
Cfg_HasSIPCavity	BOOL		0	1 = Valve supports SIP Cavity State (6).
Cfg_HasSIPLower	BOOL		0	1 = Valve supports SIP Lower Seat State (8).
Cfg_HasSIPUpper	BOOL		0	1 = Valve supports SIP Upper Seat State (10).
Cfg_PulseLiftLower	BOOL		0	1 = Pulse seat lift output when doing Lift Lower.
Cfg_PulseLiftUpper	BOOL		0	1 = Pulse seat lift output when doing Lift Upper.
Cfg_PulseSIPLower	BOOL		0	1 = Pulse seat lift output when doing SIP/CIP Lower.
Cfg_PulseSIPUpper	BOOL		0	1 = Pulse seat lift output when doing SIP/CIP Upper.
Cfg_HasPermObj	BOOL		0	1 = Tells HMI a permissive object (for example, P_Perm) is used for Inp_PermOK and navigation to the permissive object's faceplate is enabled. <b>IMPORTANT:</b> The name of the Permissive object in the controller must be this object's name with the suffix '_Perm'. For example, if your P_ValveMP object has the name 'ValveMP123', then its Permissive object must be named 'ValveMP123_Perm'.
Cfg_HasIntlkObj	BOOL		0	1 = Tells HMI an interlock object (for example, P_Intlk) is used for Inp_IntlkOK and navigation to the interlock object's faceplate is enabled. <b>IMPORTANT:</b> The name of the interlock object in the controller must be this object's name with the suffix '_Intlk'. For example, if your P_ValveMP object has the name 'ValveMP123', then its interlock object must be named 'ValveMP123_Intlk'.
Cfg_HasStatsObj	BOOL		0	1 = Tells HMI a valve statistics object (for example, P_ValveStats) is used and navigation to the valve statistics object's faceplate is enabled. <b>IMPORTANT:</b> The name of the Valve Statistics object in the controller must be this object's name with the suffix '_ValveStats'. For example, if your P_ValveMP object has the name 'ValveMP123', then its Interlock object must be named 'ValveMP123_ValveStats'.
Cfg_PCmdClear	BOOL	Mode.Cfg_PCmdClear	1	When this parameter is 1, program commands are cleared once they are acted upon. When set to 0, program commands remain set until cleared by the application program logic. <b>IMPORTANT:</b> Clearing this parameter online can cause unintended program command execution.
Cfg_ProgDefault	BOOL	Mode.Cfg_ProgDefault	0	This parameter defines the default mode. When this parameter is 1, the mode defaults to Program if no mode is being requested. When this parameter is 0, the mode defaults to Operator if no mode is being requested. <b>IMPORTANT:</b> Changing this parameter online can cause unintended mode changes.
Cfg_OCmdResets	BOOL		0	1 = New Operator valve command resets fault. 0 = Reset required to clear fault.
Cfg_OvrPermIntlk	BOOL		0	1 = Override ignores bypassable permissives and interlocks. 0 = Always use permissives and interlocks.

**Table 6 - P\_ValveMP Input Parameters**

Input Parameter	Data Type	Alias For	Default	Description
Cfg_ShedOnFail	BOOL		1	1 = Close valve and alarm on Position Fail. 0 = Alarm only on Fail. <b>IMPORTANT:</b> If a condition is configured to shed the device to the Off state on a fault, a reset is required to clear the shed fault to command the device to a state other than closed.
Cfg_ShedOnIOFault	BOOL		1	1 = Close Valve and Alarm on I/O Fault. 0 = Alarm only on I/O Fault. <b>IMPORTANT:</b> If a condition is configured to shed the device to the Off state on a fault, a reset is required to clear the shed fault to command the device to a state other than closed.
Cfg_HasFailAlm	BOOL	Fail.Cfg_Exists	0	These parameters determine whether the corresponding alarm exists and is checked or if the alarm does not exist and is not used. When these parameters are 1, the corresponding alarm exists.
Cfg_HasIntlkTripAlm		IntlkTrip.Cfg_Exists		
Cfg_HasIOFaultAlm		IOFault.Cfg_Exists		
Cfg_FailResetReqd	BOOL	Fail.Cfg_ResetReqd	0	These parameters determine whether a reset is required to clear the alarm status. When these parameters are 1, the alarm is latched ON when the alarm occurs. After the alarm condition returns to normal, a reset is required to clear the alarm status (for example, OCmd_Reset, Inp_Reset, or Fail.OCmd_Reset is required to clear Alm_Fail alarm after the alarm is set and the value returns to normal). When this parameter is 0, no reset is required and the alarm status is cleared when the alarm condition returns to normal. <b>IMPORTANT:</b> If the reset clears the alarm, it also acknowledges the alarm.
Cfg_IntlkTripResetReqd		IntlkTrip.Cfg_ResetReqd		
Cfg_IOFaultResetReqd		IOFault.Cfg_ResetReqd		
Cfg_FailAckReqd	BOOL	Fail.Cfg_AckReqd	1	These parameters determine whether an acknowledgement is required for an alarm. When these parameters are 1, the acknowledge (ack) bit is cleared when the alarm occurs. An acknowledge command (for example, PCmd_FailAck or Fail.OCmd_Ack) is required to acknowledge the alarm. When set to 0, the Acknowledge bit is set when an alarm occurs indicating an acknowledged alarm and no acknowledge command is required.
Cfg_IntlkTripAckReqd		IntlkTrip.Cfg_AckReqd		
Cfg_IOFaultAckReqd		IOFault.Cfg_AckReqd		
Cfg_PulseOpenT	REAL		10.0	Time to lift seat when pulsing seat for cleaning (seconds).
Cfg_PulseCloseT	REAL		5.0	Time to close seat when pulsing seat for cleaning (seconds).
Cfg_FailT	DINT		3	Time to give valve to achieve state before declaring valve failure (seconds).
Cfg_FailSeverity	INT	Fail.Cfg_Severity	1000	These parameters determine the severity of each alarm that gauges the color and symbol that are used to indicate alarm status on the faceplate and global object. The following are valid values: 1...250 = Low 251...500 = Medium 501...750 = High 751...1000 = Urgent <b>IMPORTANT:</b> For FactoryTalk View software version 7.0, these severity priorities drive only the indication on the global object and faceplate. The Alarm & Events definition severity drives the color and symbol that is used on the alarm banner and alarm summary as well as the value returned by the FactoryTalk Alarm and Events software display commands.
Cfg_IntlkTripSeverity		IntlkTrip.Cfg_Severity	500	
Cfg_IOFaultSeverity		IOFault.Cfg_Severity	1000	
PSet_Owner	DINT		0	Program Owner request ID (non-zero) or release (zero).

**Table 6 - P\_ValveMP Input Parameters**

Input Parameter	Data Type	Alias For	Default	Description
PCmd_Close	BOOL		0	When Cfg_PCcmdClear is 1: <ul style="list-style-type: none"> <li>Set PCmd_Close to 1 to close the valve</li> <li>Set PCmd_Open to 1 to open the valve</li> <li>Set PCmd_LiftLower to 1 lift the lower seat for cleaning</li> <li>Set PCmd_LiftUpper to 1 to lift the upper seat for cleaning</li> <li>Set PCmd_SIPCavity to 1 to SIP valve leakage cavity</li> <li>Set PCmd_SIPLower to 1 to SIP through lower seat</li> <li>Set PCmd_SIPUpper to 1 to SIP through upper seat</li> <li>These parameters reset automatically</li> </ul> When Cfg_PCcmdClear is 0: <ul style="list-style-type: none"> <li>Set PCmd_Close to 1 to close the valve</li> <li>Set PCmd_Open to 1 to open the valve</li> <li>Set PCmd_LiftLower to 1 lift the lower seat for cleaning</li> <li>Set PCmd_LiftUpper to 1 to lift the upper seat for cleaning</li> <li>Set PCmd_SIPCavity to 1 to SIP valve leakage cavity</li> <li>Set PCmd_SIPLower to 1 to SIP through lower seat</li> <li>Set PCmd_SIPUpper to 1 to SIP through upper seat</li> <li>These parameters do not reset automatically</li> </ul>
PCmd_Open				
PCmd_LiftLower				
PCmd_LiftUpper				
PCmd_SIPCavity				
PCmd_SIPLower				
PCmd_SIPUpper				
PCmd_Acq	BOOL	Mode.PCmd_Acq	0	When Cfg_PCcmdClear is 1: <ul style="list-style-type: none"> <li>Set PCmd_Acq to 1 to Acquire</li> <li>Set PCmd_Rel to 1 to Release</li> <li>These parameters reset automatically</li> </ul> When Cfg_PCcmdClear is 0: <ul style="list-style-type: none"> <li>Set PCmd_Acq to 1 to Acquire</li> <li>Set PCmd_Acq to 0 to Release</li> <li>PCmd_Rel is not used</li> <li>These parameters do not reset automatically</li> </ul>
PCmd_Rel		Mode.PCmd_Rel		
PCmd_Lock		Mode.PCmd_Lock		When Cfg_PCcmdClear is 1: <ul style="list-style-type: none"> <li>Set PCmd_Lock to 1 to Lock</li> <li>Set PCmd_Unlock to 1 to Unlock</li> <li>These parameters reset automatically</li> </ul> When Cfg_PCcmdClear is 0: <ul style="list-style-type: none"> <li>Set PCmd_Lock to 1 to Lock</li> <li>Set PCmd_Lock to 0 to Unlock</li> <li>PCmd_Unlock is not used</li> <li>These parameters do not reset automatically</li> </ul>
PCmd_Unlock		Mode.PCmd_Unlock		
PCmd_Reset	BOOL		0	<ul style="list-style-type: none"> <li>Set PCmd_Reset to 1 to reset all alarms requiring reset</li> <li>This parameter is always reset automatically</li> </ul>
PCmd_FailAck	BOOL	Fail.PCmd_Ack	0	<ul style="list-style-type: none"> <li>Set PCmd_&lt;Alarm&gt;Ack to 1 to Acknowledge alarm</li> <li>The parameter is reset automatically</li> </ul>
PCmd_IntlTripAck		IntlTrip.PCmd_Ack		
PCmd_IOFaultAck		IOFault.PCmd_Ack		
PCmd_FailSuppress	BOOL	Fail.PCmd_Suppress	0	When Cfg_PCcmdClear is 1: <ul style="list-style-type: none"> <li>Set PCmd_&lt;Alarm&gt;Suppress to 1 to suppress alarm</li> <li>Set PCmd_&lt;Alarm&gt;Unsuppress to 1 to unsuppress alarm</li> <li>These parameters reset automatically</li> </ul> When Cfg_PCcmdClear is 0: <ul style="list-style-type: none"> <li>Set PCmd_&lt;Alarm&gt;Suppress to 1 to suppress alarm</li> <li>Set PCmd_&lt;Alarm&gt;Suppress to 0 to unsuppress alarm</li> <li>PCmd_&lt;Alarm&gt;Unsuppress is not used</li> <li>These Parameters do not reset automatically</li> </ul>
PCmd_IntlTripSuppress		IntlTrip.PCmd_Suppress		
PCmd_IOFaultSuppress		IOFault.PCmd_Suppress		
PCmd_FailUnsuppress		Fail.PCmd_Unsuppress		
PCmd_IntlTripUnsuppress		IntlTrip.PCmd_Unsuppress		
PCmd_IOFaultUnsuppress		IOFault.PCmd_Unsuppress		
PCmd_FailUnshelve	BOOL	Fail.PCmd_Unshelve	0	<ul style="list-style-type: none"> <li>Set PCmd_&lt;Alarm&gt;Unshelve to 1 to Unshelve alarm</li> <li>The parameter is reset automatically</li> </ul>
PCmd_IntlTripUnshelve		IntlTrip.PCmd_Unshelve		
PCmd_IOFaultUnshelve		IOFault.PCmd_Unshelve		
OCmd_Close	BOOL		0	Operator command to close valve.
OCmd_Open	BOOL		0	Operator command to open valve.

**Table 6 - P\_ValveMP Input Parameters**

Input Parameter	Data Type	Alias For	Default	Description
OCmd_LiftLower	BOOL		0	Operator command to Lift Lower Seat for cleaning.
OCmd_LiftUpper	BOOL		0	Operator command to Lift Upper Seat for cleaning.
OCmd_SIPCavity	BOOL		0	Operator command to SIP valve leakage cavity.
OCmd_SIPLower	BOOL		0	Operator command to SIP through Lower Seat.
OCmd_SIPUpper	BOOL		0	Operator command to SIP through Upper Seat.
OCmd_Bypass	BOOL		0	Operator command to bypass all bypassable interlocks and permissives.
OCmd_Check	BOOL		0	Operator command to check (not bypass) all interlocks and permissives.
MCmd_Disable	BOOL		0	Maintenance command to disable valve.
MCmd_Enable	BOOL		0	Maintenance command to enable (allow to energize) valve.
MCmd_Acq	BOOL	Mode.MCmd_Acq	0	Maintenance command to acquire ownership (Operator/Program/Override to Maintenance)
MCmd_Rel	BOOL	Mode.MCmd_Rel	0	Maintenance command to release ownership (Maintenance to Operator/Program/Override)
OCmd_AcqLock	BOOL	Mode.OCmd_AcqLock	0	Operator command to acquire (Program to Operator) / lock ownership.
OCmd_Unlock	BOOL	Mode.OCmd_UnlockRel	0	Operator command to unlock / release (Operator to Program) ownership.
OCmd_Reset	BOOL		0	Operator command to reset all alarms requiring reset.
OCmd_ResetAckAll	BOOL		0	Operator command to reset and acknowledge all alarms and latched shed conditions.

## Mix-proof Valve Output Structure

Output parameters include the following:

- Output data elements (Out\_) are the primary outputs of the instruction, typically used by hardware output modules; however, they can be used by other application logic.
- Value data elements (Val\_) are numeric outputs of the instruction for use by the HMI. Values can also be used by other application logic or software packages.
- Source and Quality data elements (SrcQ\_) are outputs of the instruction used by the HMI to indicate PV source and quality.
- Status data elements (Sts\_) are bit outputs of the instruction for use by the HMI. Status bits can also be used by other application logic.
- Error data elements (Err\_) are outputs of the instruction that indicate a particular configuration error. If any Err\_bit is set then the Sts\_Err configuration error summary status is set and the Invalid Configuration indicator is displayed on the HMI.
- Not Ready data elements (Nrdy\_) are bit outputs of the instruction for use by the HMI for displaying the Device Not Ready indicator. Not Ready bits can also be used by other application logic.
- Alarm data elements (Alm\_) are outputs of the instruction that indicate a particular alarm has occurred.



- Acknowledge data elements (Ack\_) are outputs of the instruction that indicate the corresponding alarm has been acknowledged.
- Ready data elements (Rdy\_) are bit outputs of the instruction used by the HMI to enable or disable Command buttons and Setting entry fields.

**Table 7 - P\_ValveMP Output Parameters**

Output Parameter	Data Type	Alias For	Description
EnableOut	BOOL		Enable output: The EnableOut signal is not manipulated by this instruction. Its output state always reflects EnableIn input state.
Out_Open	BOOL		Output to Open Valve.
Out_Close	BOOL		Output to Close Valve.
Out_LiftLower	BOOL		Output to Lift Lower Seat for cleaning.
Out_LiftUpper	BOOL		Output to Lift Upper Seat for cleaning.
Out_CavityInlet	BOOL		Output to Cavity Inlet Valve (usually fail closed).
Out_CavityOutlet	BOOL		Output to Cavity Outlet Valve (usually fail open).
SrcQ_IO	SINT		I/O signal source and quality.
SrcQ			Final valve status source and quality. GOOD    0 = I/O live and confirmed good quality 1 = I/O live and assumed good quality 2 = No feedback configured, assumed good quality TEST    8 = Device simulated 9 = Device loopback simulation 10 = Manually entered value UNCERTAIN 16 = Live input, off-specification 17 = Value substituted at device/bus 18 = Value substituted by maintenance (Has and not Use) 19 = Shed, using last good value 20 = Shed, using replacement value BAD      32 = Signal failure (out-of-range, NaN, invalid combination) 33 = I/O channel fault 34 = I/O module fault 35 = Bad I/O configuration (for example, scaling parameters)
Val_Cmd	SINT		Device command: 0 = None 1 = Close 3 = Open 4 = Lift lower seat 5 = Lift upper seat 6 = CIP/SIP cavity inlet 8 = CIP/SIP lower seat 10 = CIP/SIP upper seat

**Table 7 - P\_ValveMP Output Parameters**

Output Parameter	Data Type	Alias For	Description
Val_Sts	SINT		Device confirmed: 0 = Unknown 1 = Closed 3 = Opened 4 = Lift lower seat 5 = Lift upper seat 6 = CIP/SIP cavity inlet 7 = CIP/SIP lower seat 8 = CIP/SIP upper seat 9 = Moving 12 = Pulse lower 13 = Pulse upper 33 = Disabled
Val_Fault	SINT		Device fault: 0 = None 16 = Position fail 32 = I/O Fault 34 = Configuration error
Val_State	SINT		Actual state number in state diagram: 0 = De-energized 1 = Close 2 = Close cavity out 3 = Open 4 = Lift lower seat 5 = Lift upper seat 6 = SIP/CIP cavity 7 = Lift lower first 8 = SIP/CIP lower seat 9 = Lift upper first 10 = SIP/CIP upper seat
Val_Mode	SINT	Mode.Val	The current mode is shown with status bits and also as an enumeration 'Val_Mode' as follows: 0 = No mode 1 = Hand 2 = Maintenance 3 = Override 4 = Program (locked) 5 = Operator (locked) 6 = Program (unlocked, Operator is default) 7 = Operator (unlocked, Program is default) 8 = Program (unlocked, Program is default) 9 = Operator (unlocked, Operator is default)
Val_Owner	DINT		Current Object Owner ID: 0 = Not owned.
Val_Notify	SINT		Current alarm level and acknowledgement (enumeration): 0 = No alarm 1 = Alarm cleared: a reset or acknowledge is required 2 = Low (acknowledged) 3 = Low (unacknowledged) 4 = Medium (acknowledged) 5 = Medium (unacknowledged) 6 = High (acknowledged) 7 = High (unacknowledged) 8 = Urgent (acknowledged) 9 = Urgent (unacknowledged)

Table 7 - P\_ValveMP Output Parameters

Output Parameter	Data Type	Alias For	Description
Sts_Closed	BOOL		1 = Valve requested to close and is confirmed closed.
Sts_Opened	BOOL		1 = Valve requested to open and is confirmed opened.
Sts_LiftLower	BOOL		1 = Valve Lower Seat Lift position achieved.
Sts_LiftUpper	BOOL		1 = Valve Upper Seat Lift position achieved.
Sts_SIPCavity	BOOL		1 = Valve Cavity SIP position achieved.
Sts_SIPLower	BOOL		1 = Valve Lower Seat SIP position achieved.
Sts_SIPUpper	BOOL		1 = Valve Upper Seat SIP position achieved.
Sts_Moving	BOOL		1 = Valve moving to target position, not yet achieved.
Sts_Pulsing	BOOL		1 = Valve pulsing seat for cleaning.
Sts_Available	BOOL		1 = Valve available for control by automation (Program).
Sts_Bypass	BOOL		1 = Bypassable Interlocks and Permissives are bypassed.
Sts_BypActive	BOOL		1 = Bypassing active (Bypassed or Maintenance).
Sts_Disabled	BOOL		1 = Valve is disabled.
Sts_NotRdy	BOOL		1 = Valve is not ready to energize (independent of mode).
Nrdy_Disabled	BOOL		1 = Device Not Ready: <ul style="list-style-type: none"> <li>• Device disabled by Maintenance</li> <li>• Configuration Error</li> <li>• Interlock not OK</li> <li>• Permissive not OK</li> <li>• Device Failure (Shed requires reset)</li> <li>• I/O Fault (Shed requires reset)</li> <li>• Device Logic disabled/no mode</li> </ul>
Nrdy_CfgErr			
Nrdy_Intlk			
Nrdy_Perm			
Nrdy_Fail			
Nrdy_IOFault			
Nrdy_NoMode			
Sts_MaintByp	BOOL		1 = Maintenance bypass is active, display icon.
Sts_Almlnh	BOOL		1 = Alarm is shelved, disabled or suppressed, display icon.
Sts_Err	BOOL		1 = Error in configuration: See detail bits for reason.
Err_Fail	BOOL		1 = Error in configuration: Invalid failure time (use 0...2,147,483 seconds).
Err_Timer	BOOL		1 = Error in configuration: Invalid feedback time or pulse time (use 0...2,147,483 seconds).
Err_Alarm	BOOL		1 = Error in configuration: Alarm minimum On time or severity.
Sts_Hand	BOOL	Mode.Sts_Hand	1 = Mode is Hand (supersedes Maintenance, Override, Program, Operator).
Sts_Maint	BOOL	Mode.Sts_Maint	1 = Mode is Maintenance (supersedes Override, Program, Operator).
Sts_Ovrd	BOOL	Mode.Sts_Ovrd	1 = Mode is Override (supersedes Program, Operator).
Sts_Prog	BOOL	Mode.Sts_Prog	1 = Mode is Program (auto).
Sts_Oper	BOOL	Mode.Sts_Oper	1 = Mode is Operator (manual).
Sts_ProgOperLock	BOOL	Mode.Sts_ProgOperLock	1 = Program or Operator has requested Mode Lock.
Sts_NoMode	BOOL	Mode.Sts_NoMode	1 = No mode (disabled because EnableIn is false).
Sts_MACqRcvd	BOOL	Mode.Sts_MACqRcvd	1 = Maintenance Acquire command received this scan.

**Table 7 - P\_ValveMP Output Parameters**

Output Parameter	Data Type	Alias For	Description
Sts_Fail	BOOL	Fail.Inp	Valve failure status: 0 = OK 1 = Failed
Sts_IntlkTrip		IntlkTrip.Inp	1 = Valve de-energized by an interlock not OK.
Sts_IOFault		IOFault.Inp	I/O communication fault status: 0 = OK 1 = Bad
Alm_Fail	BOOL	Fail.Alm	1 = Valve Failure alarm.
Alm_IntlkTrip		IntlkTrip.Alm	1 = Alarm: Valve de-energized by an interlock not OK.
Alm_IOFault		IOFault.Alm	1 = I/O Fault alarm.
Ack_Fail	BOOL	Fail.Ack	1 = Valve Failure, Interlock Trip, or I/O Fault alarm has been acknowledged.
Ack_IntlkTrip		IntlkTrip.Ack	
Ack_IOFault		IOFault.Ack	
Sts_FailDisabled	BOOL	Fail.Disabled	1 = Valve Failure, Interlock Trip, or I/O Fault alarm is disabled (by maintenance).
Sts_IntlkTripDisabled		IntlkTrip.Disabled	
Sts_IOFaultDisabled		IOFault.Disabled	
Sts_FailShelved	BOOL	Fail.Shelved	1 = Valve Failure, Interlock Trip, or I/O Fault alarm is inhibited by operator.
Sts_IntlkTripShelved		IntlkTrip.Shelved	
Sts_IOFaultShelved		IOFault.Shelved	
Sts_FailSuppressed	BOOL	Fail.Suppressed	1 = Valve Failure, Interlock Trip, or I/O Fault alarm is suppressed (by program).
Sts_IntlkTripSuppressed		IntlkTrip.Suppressed	
Sts_IOFaultSuppressed		IOFault.Suppressed	
Rdy_Close	BOOL		1 = Ready to receive OCmd_Close, OCmd_Open, OCmd_LiftLower, OCmd_LiftUpper, OCmd_SIPCavity, OCmd_SIPLower, OCmd_SIPUpper, OCmd_Bypass, or OCmd_Check (enables HMI button).
Rdy_Open			
Rdy_LiftLower			
Rdy_LiftUpper			
Rdy_SIPCavity			
Rdy_SIPLower			
Rdy_SIPUpper			
Rdy_Bypass			
Rdy_Check			
Rdy_Disable	BOOL		1 = Ready to receive MCmd_Disable (enables HMI button).
Rdy_Enable	BOOL		1 = Ready to receive MCmd_Enable (enables HMI button).
Rdy_Reset	BOOL		1 = Ready to receive OCmd_Reset (enables HMI button).
Rdy_ResetAckAll	BOOL		1 = At least one alarm or latched shed condition requires reset or acknowledged.
P_ValveMP	BOOL		Unique parameter name for auto-discovery.

## Mix-proof Valve Local Configuration Tags

Configuration parameters that are arrayed, string, or structure data types cannot be configured as parameters for Add-On Instructions. Configuration parameters of these types appear as local tags to the Add-On Instruction. Local tags can be configured through the HMI faceplates or in Studio 5000 Logix Designer® application by opening the Instruction Logic of the Add-On Instruction instance and then opening the Data Monitor on a local tag. These parameters cannot be modified by using controller logic or Logix Designer application export/import functionality.

**Table 8 - Local Configuration Tags**

Tag Name	Data Type	Default	Description																												
Cfg_Desc	STRING_40	'Mix Proof Valve'	Description for display on HMI. This string is shown in the title bar of the faceplate.																												
Cfg_Label	STRING_20	'Valve Control'	Label for graphic symbol displayed on HMI. This string appears on the graphic symbol.																												
Cfg_Tag	STRING_20	'P_ValveMP'	Tagname for display on HMI. This string is shown in the title bar of the faceplate..																												
Cfg_OutStateTbl	SINT [11]	[0] 2#0000_0000 [1] 2#0000_0001 [2] 2#0010_0000 [3] 2#0010_0010 [4] 2#0000_0100 [5] 2#0000_1000 [6] 2#0001_0000 [7] 2#0001_0100 [8] 2#0011_0100 [9] 2#0001_1000 [10] 2#0011_1000	<p>Valve state tables showing, respectively, output states in given valve state, feedback inputs required (checked) to achieve valve state, and feedback input states to achieve valve state.</p> <p>The array index ([0]...[10]) indicates the device state as follows (per the state diagram in the manual):</p> <table border="1"> <thead> <tr> <th>Index</th> <th>Function</th> </tr> </thead> <tbody> <tr> <td>[0]</td> <td>(intermediate state) De-energized</td> </tr> <tr> <td>[1]</td> <td>Closed</td> </tr> <tr> <td>[2]</td> <td>(intermediate state) Close cavity outlet</td> </tr> <tr> <td>[3]</td> <td>Opened</td> </tr> <tr> <td>[4]</td> <td>Lift Lower Seat</td> </tr> <tr> <td>[5]</td> <td>Lift Upper Seat</td> </tr> <tr> <td>[6]</td> <td>SIP/CIP Cavity</td> </tr> <tr> <td>[7]</td> <td>(intermediate) Lift Lower for SIP/CIP</td> </tr> <tr> <td>[8]</td> <td>SIP/CIP Lower Seat</td> </tr> <tr> <td>[9]</td> <td>(intermediate) Lift Upper for SIP/CIP</td> </tr> <tr> <td>[10]</td> <td>SIP/CIP Upper Seat</td> </tr> </tbody> </table>	Index	Function	[0]	(intermediate state) De-energized	[1]	Closed	[2]	(intermediate state) Close cavity outlet	[3]	Opened	[4]	Lift Lower Seat	[5]	Lift Upper Seat	[6]	SIP/CIP Cavity	[7]	(intermediate) Lift Lower for SIP/CIP	[8]	SIP/CIP Lower Seat	[9]	(intermediate) Lift Upper for SIP/CIP	[10]	SIP/CIP Upper Seat				
Index	Function																														
[0]	(intermediate state) De-energized																														
[1]	Closed																														
[2]	(intermediate state) Close cavity outlet																														
[3]	Opened																														
[4]	Lift Lower Seat																														
[5]	Lift Upper Seat																														
[6]	SIP/CIP Cavity																														
[7]	(intermediate) Lift Lower for SIP/CIP																														
[8]	SIP/CIP Lower Seat																														
[9]	(intermediate) Lift Upper for SIP/CIP																														
[10]	SIP/CIP Upper Seat																														
Cfg_FdbkReqdTbl	SINT [11]	[0] 2#0000_0000 [1] 2#0000_0000 [2] 2#0000_0000 [3] 2#0000_0000 [4] 2#0000_0000 [5] 2#0000_0000 [6] 2#0000_0000 [7] 2#0000_0000 [8] 2#0000_0000 [9] 2#0000_0000 [10] 2#0000_0000	<p>The bits within a word indicate an input or output state (1=on, 0=off) or if the input state is checked (FdbkReqd = 1 = input checked, 0 = not checked). The bit positions are:</p> <table border="1"> <thead> <tr> <th>Bit</th> <th>Function</th> <th>Input</th> <th>Output</th> </tr> </thead> <tbody> <tr> <td>Bit .0</td> <td>Close valve</td> <td>Inp_ClosedLS</td> <td>Out_Close</td> </tr> <tr> <td>Bit .1</td> <td>Open Valve</td> <td>Inp_OpenLS</td> <td>Out_Open</td> </tr> <tr> <td>Bit .2</td> <td>Lift Lower Seat</td> <td>Inp_LowerLS</td> <td>Out_LiftLower</td> </tr> <tr> <td>Bit .3</td> <td>Lift Upper Seat</td> <td>Inp_UpperLS</td> <td>Out_LiftUpper</td> </tr> <tr> <td>Bit .4</td> <td>Open Cavity Inlet</td> <td>Inp_CavityInLS</td> <td>Out_CavityInlet (FC)</td> </tr> <tr> <td>Bit .5</td> <td>Close Cavity Outlet</td> <td>Inp_CavityOutLS</td> <td>Out_CavityOutlet (FO)</td> </tr> </tbody> </table>	Bit	Function	Input	Output	Bit .0	Close valve	Inp_ClosedLS	Out_Close	Bit .1	Open Valve	Inp_OpenLS	Out_Open	Bit .2	Lift Lower Seat	Inp_LowerLS	Out_LiftLower	Bit .3	Lift Upper Seat	Inp_UpperLS	Out_LiftUpper	Bit .4	Open Cavity Inlet	Inp_CavityInLS	Out_CavityInlet (FC)	Bit .5	Close Cavity Outlet	Inp_CavityOutLS	Out_CavityOutlet (FO)
Bit	Function	Input	Output																												
Bit .0	Close valve	Inp_ClosedLS	Out_Close																												
Bit .1	Open Valve	Inp_OpenLS	Out_Open																												
Bit .2	Lift Lower Seat	Inp_LowerLS	Out_LiftLower																												
Bit .3	Lift Upper Seat	Inp_UpperLS	Out_LiftUpper																												
Bit .4	Open Cavity Inlet	Inp_CavityInLS	Out_CavityInlet (FC)																												
Bit .5	Close Cavity Outlet	Inp_CavityOutLS	Out_CavityOutlet (FO)																												
Cfg_FdbkStateTbl	SINT [11]	[0] 2#0000_0000 [1] 2#0000_0001 [2] 2#0010_0000 [3] 2#0010_0010 [4] 2#0000_0100 [5] 2#0000_1000 [6] 2#0001_0000 [7] 2#0001_0100 [8] 2#0011_0100 [9] 2#0001_1000 [10] 2#0011_1000	<p>The bits within a word indicate an input or output state (1=on, 0=off) or if the input state is checked (FdbkReqd = 1 = input checked, 0 = not checked). The bit positions are:</p> <table border="1"> <thead> <tr> <th>Bit</th> <th>Function</th> <th>Input</th> <th>Output</th> </tr> </thead> <tbody> <tr> <td>Bit .0</td> <td>Close valve</td> <td>Inp_ClosedLS</td> <td>Out_Close</td> </tr> <tr> <td>Bit .1</td> <td>Open Valve</td> <td>Inp_OpenLS</td> <td>Out_Open</td> </tr> <tr> <td>Bit .2</td> <td>Lift Lower Seat</td> <td>Inp_LowerLS</td> <td>Out_LiftLower</td> </tr> <tr> <td>Bit .3</td> <td>Lift Upper Seat</td> <td>Inp_UpperLS</td> <td>Out_LiftUpper</td> </tr> <tr> <td>Bit .4</td> <td>Open Cavity Inlet</td> <td>Inp_CavityInLS</td> <td>Out_CavityInlet (FC)</td> </tr> <tr> <td>Bit .5</td> <td>Close Cavity Outlet</td> <td>Inp_CavityOutLS</td> <td>Out_CavityOutlet (FO)</td> </tr> </tbody> </table>	Bit	Function	Input	Output	Bit .0	Close valve	Inp_ClosedLS	Out_Close	Bit .1	Open Valve	Inp_OpenLS	Out_Open	Bit .2	Lift Lower Seat	Inp_LowerLS	Out_LiftLower	Bit .3	Lift Upper Seat	Inp_UpperLS	Out_LiftUpper	Bit .4	Open Cavity Inlet	Inp_CavityInLS	Out_CavityInlet (FC)	Bit .5	Close Cavity Outlet	Inp_CavityOutLS	Out_CavityOutlet (FO)
Bit	Function	Input	Output																												
Bit .0	Close valve	Inp_ClosedLS	Out_Close																												
Bit .1	Open Valve	Inp_OpenLS	Out_Open																												
Bit .2	Lift Lower Seat	Inp_LowerLS	Out_LiftLower																												
Bit .3	Lift Upper Seat	Inp_UpperLS	Out_LiftUpper																												
Bit .4	Open Cavity Inlet	Inp_CavityInLS	Out_CavityInlet (FC)																												
Bit .5	Close Cavity Outlet	Inp_CavityOutLS	Out_CavityOutlet (FO)																												

## Operations

This section describes the primary operations for Add-On Instructions.

### Modes

This instruction uses the following standard modes, which are implemented by using an embedded P\_Mode Add-On Instruction.

**Table 9 - Modes**

Mode	Description
Operator	The Operator owns control of the device. Operator commands (OCmd_) and Operator settings (OSet_) from the HMI are accepted.
Program	Program logic owns control of the device. Program commands (PCmd_) and Program settings (PSet_) are accepted.
Override	Priority logic owns control of the device and supersedes Operator and Program control. Override Inputs (Inp_OvrCmd and other Inp_OvrDxxx values) are accepted. If so configured, bypassable interlocks and permissives are bypassed.
Maintenance	Maintenance owns control of the device and supersedes Operator, Program, and Override control. Operator commands and settings from the HMI are accepted. Bypassable interlocks and permissives are bypassed, and device timeout checks are not processed.
Hand	Hardwired logic or other logic outside the instruction owns control of the device. The instruction tracks the state of the device for bumpless transfer back to one of the other modes.
No Mode	The device is disabled and has no owner because the EnableIn input is false. The main instruction Logic routine is not being scanned. See Execution section for more information on EnableInFalse processing.

See Rockwell Automation Library of Process Objects: Common Mode Block (P\_Mode) Reference Manual, publication [SYSLIB-RM005](#), for more information.

## Alarms

This instruction uses the following alarms, which are implemented by using embedded P\_Alarm and P\_Gate Add-On Instructions.

Alarm Name	P_Alarm Name	P_Gate Name	Description
Fail	Fail	None	Raised when the valve is commanded to a new position and the device feedbacks fail to confirm the valve reached each required position (see state diagram) within the configured time (Cfg_FailT). If the Failure is configured as a shed fault, the valve is commanded closed and cannot be opened until reset.
Interlock Trip	IntlkTrip	None	Raised when an interlock 'not OK' condition causes the valve to transition from some other position to the closed position. If interlocks are not bypassed, a bypassable interlock or a non-bypassable interlock 'not OK' condition initiates an interlock trip. If interlocks are bypassed, only a non-bypassable interlock 'not OK' condition initiates an interlock trip.
I/O Fault	IOFault	None	Raised when an interlock 'not OK' condition causes the valve to transition from some other position to the closed position. If interlocks are not bypassed, a bypassable interlock or a non-bypassable interlock 'not OK' condition initiates an interlock trip. If interlocks are bypassed, only a non-bypassable interlock 'not OK' condition initiates an interlock trip.

Parameters of the P\_Alarm object can be accessed by using the following convention: [P\_Alarm Name].[P\_Alarm Parameter].

See Rockwell Automation Library of Process Objects: Common Alarm Block (P\_Alarm) Reference Manual, publication [SYSLIB-RM002](#), for more information.

## Simulation

Simulation in P\_ValveMP disables the normal outputs and provides the feedback of a working valve.

You must set the Inp\_Sim parameter in the controller to '1' to enable simulation.

The Simulation icon  is displayed at the bottom left of the Operator faceplate indicating the device is in simulation.

When you have finished in simulation, set the Inp\_Sim parameter in the controller to '0' to return to normal operation.

## Execution

The following table explains the handling of instruction execution conditions.

Condition	Description
EnableIn False (false rung)	Handled the same as if the device were Disabled by Command. The device outputs are de-energized and the device is shown as Disabled on the HMI. The mode is shown as 'NO MODE'. All alarms are cleared.
Powerup (prescan, first scan)	On prescan, any commands received before first scan are discarded. The device is de-energized. On first scan, the device is commanded to the closed state. Embedded P_Mode and P_Alarm instructions are handled in accordance with their standard powerup procedures. See Rockwell Automation Library of Process Objects: Common Mode Block (P_Mode), publication <a href="#">SYSLIB-RM005</a> , and Rockwell Automation Library of Process Objects: Common Alarm Block (P_Alarm), publication <a href="#">SYSLIB-RM002</a> , for P_Mode and P_Alarm instructions, respectively.
Postscan	No SFC Postscan logic is provided.

See the Logix5000 Controllers Add-On Instructions Programming Manual, publication [1756-PM010](#), for more information.



## Programming Example

This example uses the P\_ValveMP instruction to implement a mix-proof valve feeding bulk material (safflower oil) from a storage silo into a mixer.

For this example, the mix-proof valve connects to the control system by using two inputs and three outputs. The manufacturer's data sheet for the valve shows the following information.

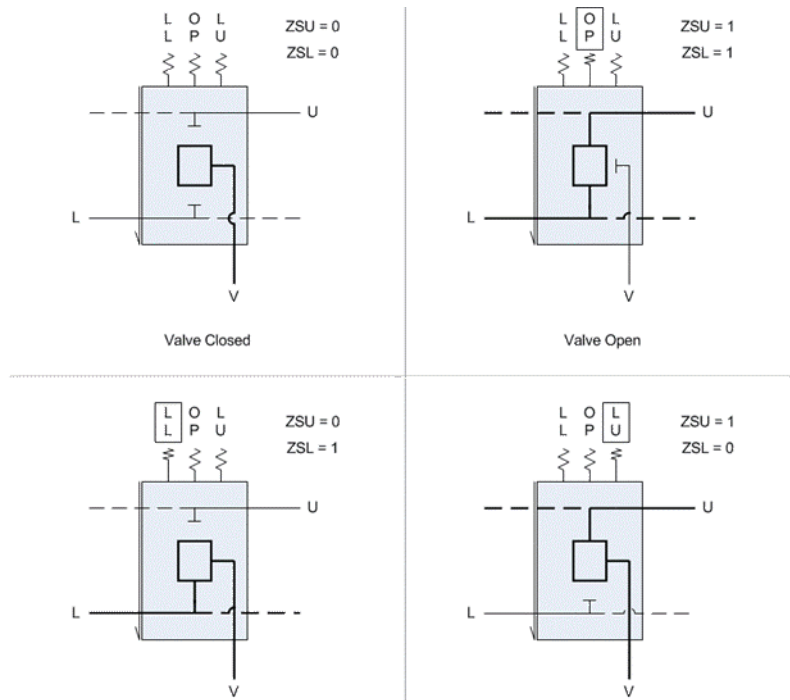

In the closed position (all outputs off), flow is not directed anywhere and the valve cavity is vented to waste recovery. In the open state, flow is directed from the upper line to the lower line. In the Lower Lift position, flow is directed from the lower line through the valve cavity to waste recovery. In the Upper Lift position, flow is directed from the upper line through the valve cavity to waste recovery.

The P\_ValveMP instruction for this valve is configured as shown in the following diagram.

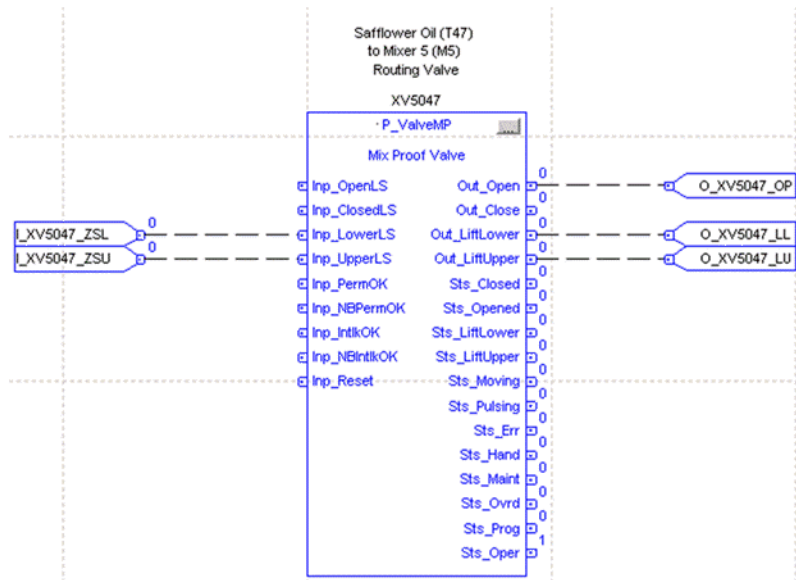

The two limit switches from the field are connected into inputs Inp\_LowerLS and Inp\_UpperLS. The three outputs to the field are connected to Out\_Open, Out\_LiftLower, and Out\_LiftUpper.

This programming example illustrates the remaining configuration by using the HMI faceplate. To use the faceplate to perform configuration, you must download the preceding instructions, have a display with a global object connected to this instruction instance, and have a FactoryTalk View software client with the appropriate security setup and access to this display. Each step of this programming example provides a listing of the configuration parameter values that were changed through the faceplate.

From the [Engineering Tab Page 1 Description on page 45](#), the descriptive strings and supported states are configured.

Parameter	Description
Cfg_Desc	Safflower Oil T-47 to Mixer M-5
Cfg_Label	Safflower T-47 / M-5
Cfg_Tag	XV-5047
Cfg_HasLiftLower, Cfg_HasLiftUpper	1 (checked)
Cfg_HasSIPCavity, Cfg_HasSIPLower, Cfg_HasSIPUpper	0 (unchecked)

From the [Engineering Tab Page 4 Description on page 49](#), the state configuration can be accessed and modified. For this example, we have to configure six states. There are three outputs only, so for each state, the outputs for Close, Cavity In, and Cavity Out can be ignored. We will also ignore feedback states for feedback that is not required. The example uses parameters for all ignored values set to 0.

The table shows the configuration for each valve state.

State	Configuration
0 - De-energized	Cfg_OutStateTbl[0] = 2#0000_0000 (all outputs are 0) Cfg_FdbkReqdTbl[0] = 2#0000_1100 (Lift Lower and Lift Upper are required) Cfg_FdbkStateTbl[0] = 2#0000_0000 (Lift Lower and Lift Upper feedback state are 0)
1 - Close	Cfg_OutStateTbl[1] = 2#0000_0001 (Close output is 1 and all others are 0, Close output set for display purposes only) Cfg_FdbkReqdTbl[1] = 2#0000_1100 (Lift Lower and Lift Upper are required) Cfg_FdbkStateTbl[1] = 2#0000_0000 (Lift Lower and Lift Upper feedback state are 0)
3 - Open	Cfg_OutStateTbl[3] = 2#0000_0010 (Open output is 1 and all others are 0) Cfg_FdbkReqdTbl[3] = 2#0000_1100 (Lift Lower and Lift Upper are required) Cfg_FdbkStateTbl[3] = 2#0000_1100 (Lift Lower and Lift Upper feedback state are 1)
2 - Close Cavity Out	Cfg_OutStateTbl[3] = 2#0000_0010 (Open output is 1 and all others are 0) Cfg_FdbkReqdTbl[3] = 2#0000_1100 (Lift Lower and Lift Upper are required) Cfg_FdbkStateTbl[3] = 2#0000_1100 (Lift Lower and Lift Upper feedback state are 1)
4 - Lift Lower Seat	Cfg_OutStateTbl[4] = 2#0000_0100 (Lift Lower output is 1 and all others are 0) Cfg_FdbkReqdTbl[4] = 2#0000_1100 (Lift Lower and Lift Upper are required) Cfg_FdbkStateTbl[4] = 2#0000_0100 (Lift Lower feedback state is 1 and Lift Upper feedback state is 0)
5 - Lift Upper Seat	Cfg_OutStateTbl[5] = 2#0000_1000 (Lift Upper output is 1 and all others are 0) Cfg_FdbkReqdTbl[5] = 2#0000_1100 (Lift Lower and Lift Upper are required) Cfg_FdbkStateTbl[5] = 2#0000_1000 (Lift Lower feedback state is 0 and Lift Upper feedback state is 1)

From the faceplate, you can open the state configuration for all valve states simultaneously to compare and configure the states. For example, [Figure 1](#) shows the state configuration for the Closed state.

On this message box, you set the states of the outputs, as well as the states of required feedback inputs, for the given valve state.

**Figure 1 - Closed State Configuration Display**

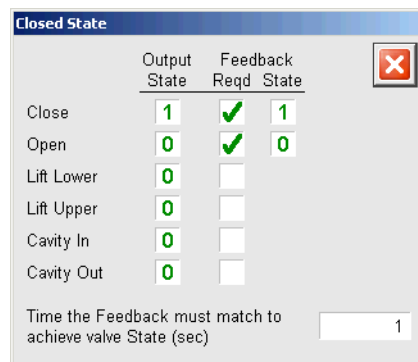

**TIP** You can open the state configuration message boxes for multiple states simultaneously. This can make it easier for you to check your selections against the documentation for your particular valve and actuator.

See [Engineering Tab Page 4 Description on page 49](#) for more information.

## Display Elements

A display element (global object) is created once and can be referenced multiple times on multiple displays in an application. When changes are made to the original (base) object, the instantiated copies (reference objects) are automatically updated. Use of global objects, in conjunction with tag structures in the ControlLogix system, aid consistency and save engineering time.

**Table 10 - P\_ValveMP Display Elements Description**

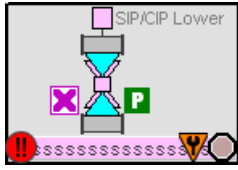
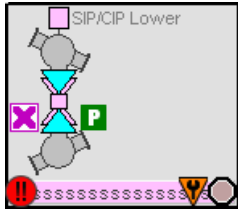
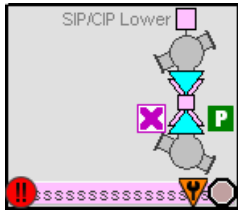
Display Element Name	Display Element	Description
GO_P_ValveMP2D		This Mix-proof Valve graphic object allows for numerous orientations on displays.
GO_P_ValveMP_Orth		This 3-D orthogonal Mix-proof Valve graphic object provides different valve angle positions on displays.
GO_P_ValveMP_Orth1		This 3-D orthogonal Mix-proof Valve graphic object provides different valve angle positions on displays.

Common attributes of the P\_ValveMP global objects include the following:

- Animated valve graphic symbol
- Text State indicator
- Instruction mode indicator
- Status/Quality indicators
- Maintenance Bypass indicator
- Label
- Color changing alarm border that blinks on unacknowledged alarm
- Alarm indicator that changes color with the severity of an alarm

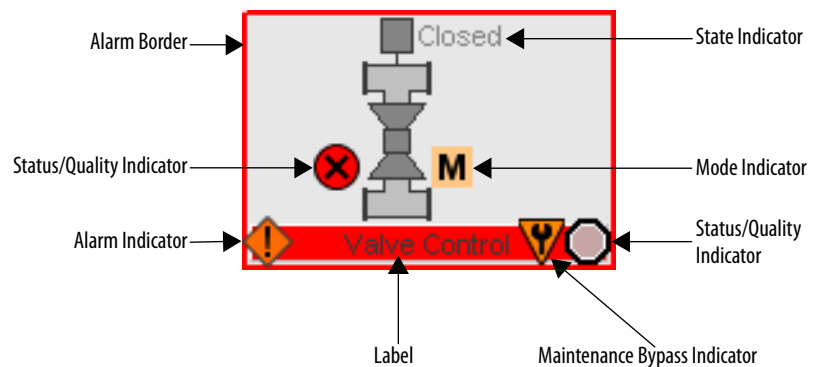

Each display element includes a touch field that accesses the object's faceplate. In addition, there is a tooltip that displays the object's configured tag and description.





## State Indicators

The state indicator text changes and the graphic symbol color changes depending on the state of the valve.

Color	State Text
Blue	Transition: Commanded to a new position and not there yet.
Light yellow	Indicates the following states: CIP/SIP cavity inlet, CIP/SIP lower seat, CIP/SIP upper seat.
Dark gray	Closed.
White	Open.
Cyan	Indicates the following states: Lift lower, Lift upper.

## Status/Quality Indicators

One of these symbols appears on the graphic symbol when the described condition is true.

Graphic Symbol	Description
	Invalid configuration.
	Data quality bad/failure.
	Data Quality degraded: uncertain, test, simulation, substitution, or out of specification.
	The input or device has been disabled.
	Device not ready to operate.

### TIP

When the Invalid Configuration Indicator appears, you can find what configuration setting is invalid by following the indicators. Click the graphic symbol to open the faceplate. The Invalid Configuration indicator appears next to the appropriate tab at the top of the faceplate to guide you in finding the configuration error. Once you navigate to the tab, this indicator or a magenta box identifies the misconfigured item.

For the Mix-proof Valve instruction, the Invalid Configuration indicator appears under the following conditions:

- An alarm minimum on time, a valve feedback time, pulse time, or the valve failure time is set to a value less than zero or greater than 2,147,483 seconds.
- Alarm Severity is set to a value less than 1 or greater than 1000.
- Invalid Feedback Time or Pulse Time (use 0...2,147,483 sec).
- Invalid Failure Time (use 0...2,147,483).

**TIP** When the Not Ready indicator appears, you can find what condition is preventing operation by following the indicators. Click the graphic symbol to open the faceplate. The Not Ready indicator appears next to the appropriate tab at the top of the faceplate to guide you in finding the condition. When you navigate to the tab, the condition preventing operation is flagged.





For the Mix-proof Valve instruction, the Device Not Ready indicator appears under the following conditions:



- Device has been disabled by Maintenance.
- There is a configuration error.
- Interlock or Permissive is not OK.
- There is a device failure and shed requires a reset.
- There is an I/O Fault and shed requires a reset.

Device Logic has been disabled or there is no mode.

## Mode Indicators

One of these symbols appears on the right side of the graphic symbol to indicate the mode of the object instruction.

Graphic Symbol	Description
Transparent	Operator mode (if the default mode is Operator and the current mode is Operator, the mode indicator is transparent).
	Operator mode (if the default mode is Program).
	Operator mode locked.
Transparent	Program mode (if the default mode is Program and the current mode is Program, the mode indicator is transparent).
	Program mode (if the default mode is Operator).
	Program mode locked.
	Override mode







Graphic Symbol	Description
	Maintenance mode.
	Hand mode
	No mode.

**TIP** The images provided for the Operator and Program default modes are transparent; therefore, no mode indicators are visible if the device is in its default mode. This behavior can be changed by replacing the image files for these mode indicators with images that are not transparent.

See Rockwell Automation Library of Process Objects: Common Mode Block (P\_Mode) Reference Manual, publication [SYSLIB-RM005](#), for more information.

## Alarm Indicators

One of these symbols appears on the left side of the label to indicate the described alarm condition and the alarm border and label background change color. The alarm border and label background blink if acknowledgement of an alarm condition is required. Once the alarm is acknowledged, the alarm border and label background remain the color that corresponds to the severity of the alarm.

Symbol	Border and Label Background	Description
	No change in color	Alarm Inhibit: an alarm is suppressed by the Program, disabled by Maintenance, or shelved by the Operator.
	White	Return to normal (no alarm condition), but a previous alarm has not been acknowledged.
	Blue	Low severity alarm.
	Yellow	Medium severity alarm.
	Red	High severity alarm.
	Magenta	Urgent severity alarm.
No symbol	No change in color	No alarm or alarm inhibit condition, and all alarms are acknowledged.

See Rockwell Automation Library of Process Objects: Common Alarm Block (P\_Alarm) Reference Manual, publication [SYSLIB-RM002](#), for more information.



## Maintenance Bypass Indicator

This symbol appears to the right of the label to indicate that a maintenance bypass has been activated.

**TIP** When the Maintenance Bypass Indicator appears, you can find what condition was bypassed by following the indicators. Click the graphic symbol to open the faceplate. The Maintenance Bypass Indicator appears next to the appropriate tab at the top of the faceplate to guide you in finding the bypass. Once you navigate to the tab, this indicator identifies the bypassed item.

For the Mix-proof Valve instruction, the Maintenance Bypass indicator appears when bypassable interlocks and permissives have been bypassed.

## Using Display Elements

The global objects for P\_ValveMP can be found in the global object file (RA-BAS) P\_ValveMP Graphics Library.ggfx.

Complete these steps to use a global object.

1. Copy it from the global object file and paste it in the display file.

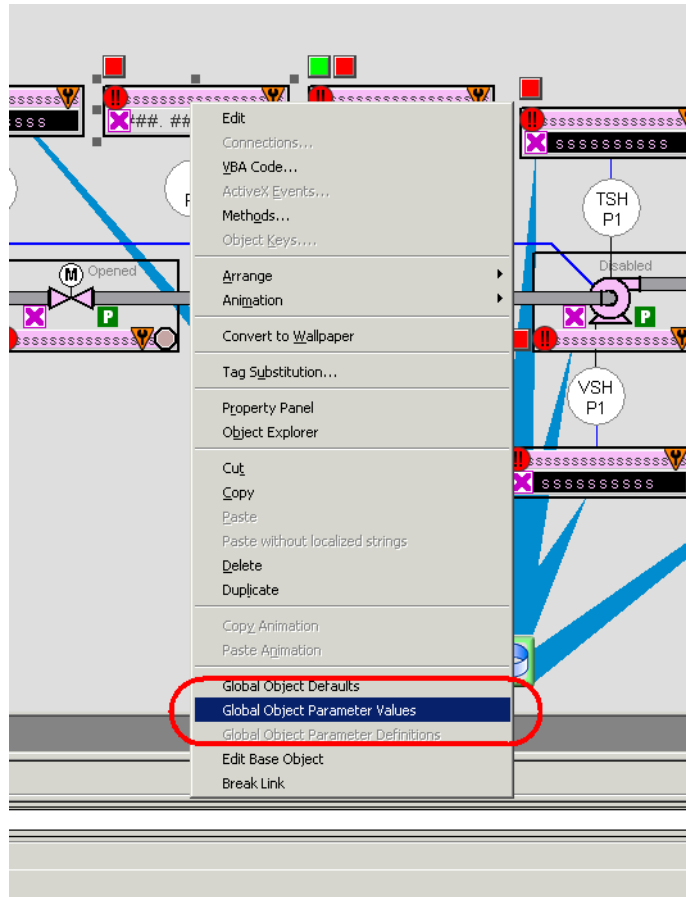

2. In the display, right-click the global object and choose Global Object Parameter Values.

The Global Object Parameter Values dialog box appears.

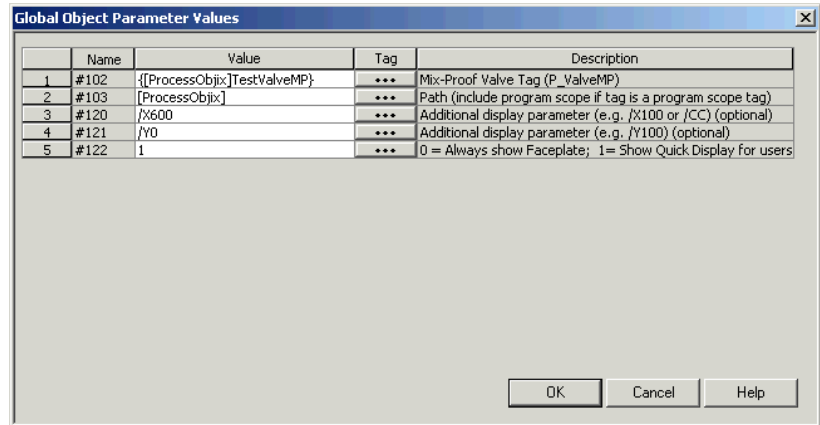

The global object parameters are as follows.

Parameter	Required	Description
#102	Y	Object tag to point to the name of the associated object Add-On Instruction in the controller.
#103	Y	Path used for display navigation features to other objects. Include program scope if tag is a program scope tag.
#120	N	Additional parameter to pass to the display command to open the faceplate. Typically used to define position for the faceplate.
#121	N	Additional parameter to pass to the display command to open the faceplate. if defining X and Y coordinate, separate parameters so that X is defined by #120 and Y is defined by #121. This lets the same parameters be used in subsequent display commands originating from the faceplate.
#122	Y	These are the options for the global object display: 0 = Always show faceplate 1 = Show Quick Display for users without Maintenance access (Code C) 2 = Always show Quick Display

3. Type the tag or value in the Value column as specified in the Description column.

**TIP** You can click the ellipsis (...) to browse and select a tag.

Values for items marked '(optional)' can be left blank.

4. Click OK.

## Quick Display

The Quick Display screen provides a means for operators to perform simple interactions with the P\_ValveMP instruction instance. From the Quick Display, you can navigate to the faceplate for full access for operation, maintenance, and configuration.

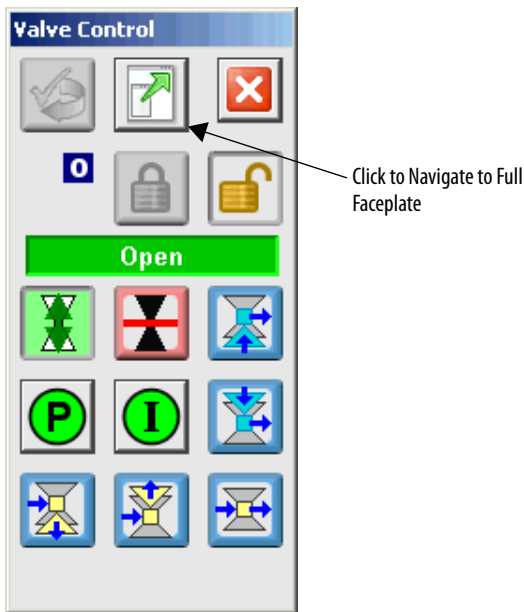

## Faceplate

The P\_ValveMP faceplate consists of five tabs and each tab consists of one or more pages.

The faceplate contains the value of local configuration tags Cfg\_Tag and Cfg\_Desc in the title bar.



The Operator tab is displayed when the faceplate is initially opened. Click the appropriate icon at the top of the faceplate to access a specific tab.

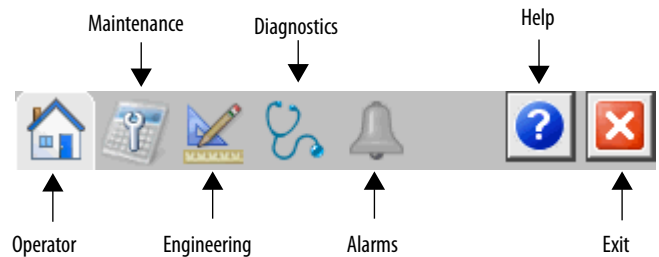

The faceplate provides the means for operators, maintenance personnel, engineers, and others to interact with the P\_ValveMP instruction instance, including viewing its status and values and manipulating it through its commands and settings. When a given input is restricted via FactoryTalk View security, the required user security code letter is shown in the tables that follow.

## Operator Tab

The Faceplate initially opens to the Operator ('Home') tab. From here, an operator can monitor the device status and manually operate the device when it is in Operator mode.





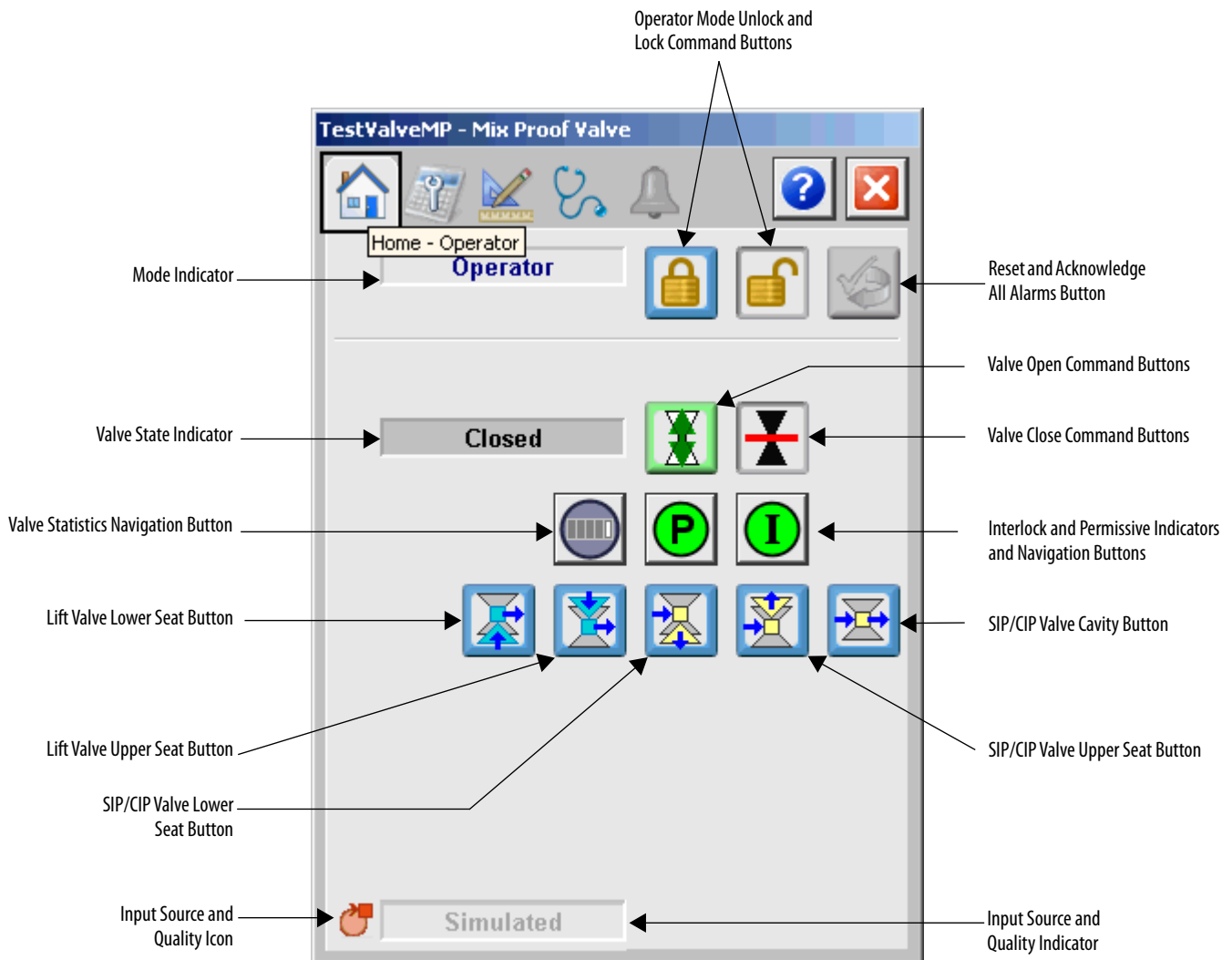







The Operator tab shows the following information:

- Current mode (Program, Operator, Override, Maintenance, or Hand)
- Requested Modes Indicator (appears only if the Operator or Program mode has been superseded by another mode)
- Mix-proof Valve state
- Valve fault status
- Valve Permissive and Interlock status
- Input Source and Quality indicator (See 'SrcQ' in the Output parameters table on [page 17](#) for details)





The following table shows the functions included on the Operator tab.

**Table 11 - Operator Tab Description**

Function	Action	Security
	Click to release Operator mode lock.	Manual Device Operation (Code B)
	Click to lock in Operator mode.	
	Click to request Program mode.	
	Click to request Operator mode.	
	Click to reset and acknowledge all alarms.	Acknowledge Alarms (Code F)
	Click to Open valve. The button is available in Operator or Maintenance mode.	Normal Operation of Device (Code A)
	Click to close valve. The button is available in Operator or Maintenance mode.	
	Click to go to the Lift Valve Lower Seat state. The button is available in Operator or Maintenance mode.	
	Click to go to the Lift Valve Upper Seat state. The button is available in Operator or Maintenance mode.	
	Click to go to the CIP/SIP Valve Lower Seat state. The button is available in Operator or Maintenance mode.	
	Click to go to the CIP/SIP Valve Upper Seat state. The button is available in Operator or Maintenance mode.	
	Click to go to the CIP/SIP Valve Cavity state. The button is available in Operator or Maintenance mode.	

**Table 11 - Operator Tab Description**

Function	Action	Security
	Click to open the Permissives faceplate.	None
	Click to open the Interlocks faceplate.	
	Click to open the Valve Statistics faceplate.	

If the object is configured to have permissive and interlock objects (for example, Cfg\_HasPermObj is true), the permissive and interlock indication become buttons that open the faceplates of the source objects used as a permissive or interlock (often this is a P\_Intlk interlock or P\_Perm permissive object). If the object is not configured in this way, the permissive or interlock are indicators only.

The Operator tab also has a button to open the Valve Statistics faceplate if the valve is configured to use the P\_ValveStats object (Cfg\_HasValveStats = 1). When the object is not configured to have an P\_ValveStats instruction, the Valve Statistics button is not displayed.

See these publications for more information:

- Rockwell Automation Library of Process Objects: Permissives with Bypass (P\_Perm) Reference Manual, publication [SYSLIB-RM007](#)
- Rockwell Automation Library of Process Objects: Interlock with First Out and Bypass (P\_Intlk) Reference Manual, publication [SYSLIB-RM004](#)
- Rockwell Automation Library of Process Objects: 2-state Valve Statistics (P\_ValveStats) Reference Manual, publication [SYSLIB-RM036](#).

One of these symbols appears to indicate the described Interlock or Permissive condition.

Permissive Symbol	Interlock Symbol	Description
		One or more conditions not OK
		Non-bypassed conditions OK
		All conditions OK, bypass active
		All conditions OK



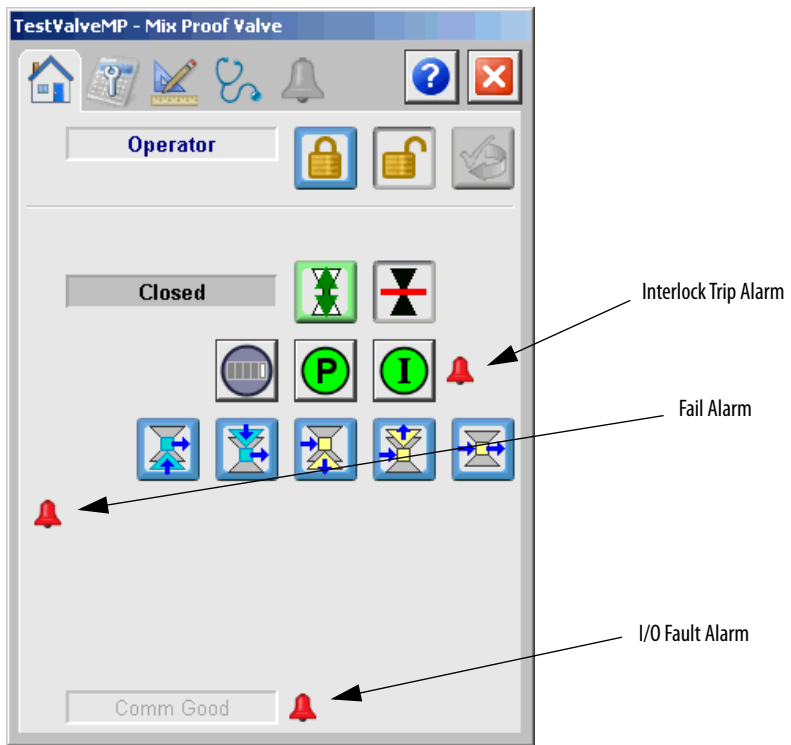



Alarm indicators appear on the Operator tab when the corresponding alarm occurs.





The following table shows the alarm status on the Operator tab.

**Table 12 - Operator Tab Alarm Status**

Graphic Symbol	Alarm Status
	In Alarm (Active Alarm)
	In Alarm and Acknowledged
	Out of Alarm but not Acknowledged
	Alarm Suppressed (by Operator) (Alarm is logged but not displayed)
	Alarm Disabled (by Maintenance)
	Alarm Shelved (by Operator)

## Maintenance Tab

Maintenance personnel use the information and controls on the Maintenance tab to adjust device parameters, troubleshoot and temporarily work around device problems, and disable the device for routine maintenance.





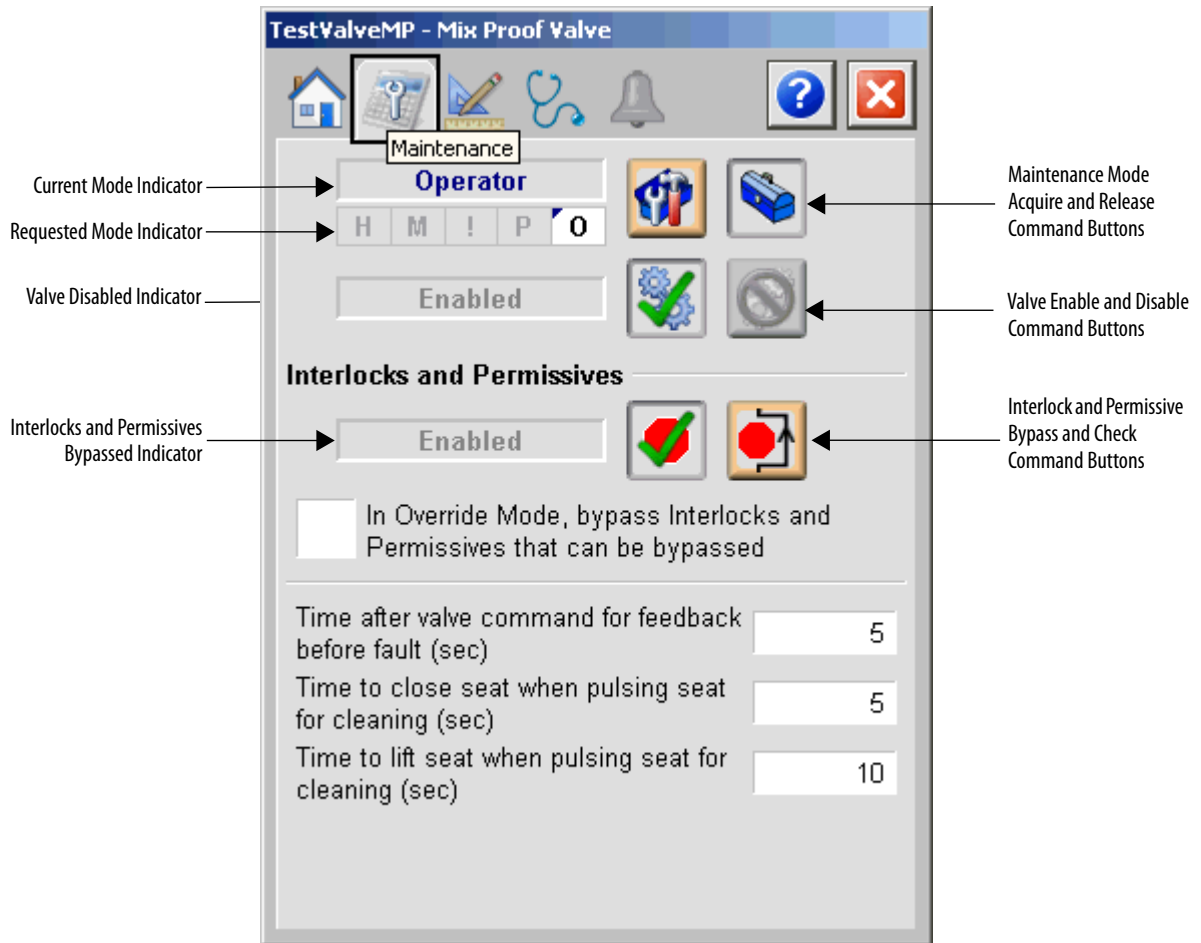

The Maintenance tab shows the following information:

- Current mode (Program, Operator, or Maintenance)
- Requested Modes Indicator - This display highlights all modes that have been requested. The leftmost highlighted mode is the active mode
- Whether Mix-proof Valve is enabled or disabled
- Interlocks and Permissive Bypassed/Enabled Indicator
- Whether Override mode bypasses the bypassable permissives and interlocks



The following table shows the functions on the Maintenance tab.

**Table 13 - Maintenance Tab Description**

Function	Action	Security	Configuration Parameters
	Click to place valve in Maintenance mode.	Equipment Maintenance (Code C)	None
	Click to release valve from Maintenance mode.		
	Click to enable valve.		
	Click to disable valve.		
	Click to enable checking of all permissives and interlocks.	Disable Alarms Bypass Permissives and Interlocks (Code H)	
	Click to bypass checking of bypassable permissives and interlocks.		
In Override Mode, bypass Interlocks and Permissives that can be bypassed	Check to bypass permissives and interlocks in Override mode.		Cfg_OvrPermIntlk
Time after valve command for feedback before fault (seconds)	Type a value (seconds) that gives the valve time to achieve state before triggering a valve failure fault.	Equipment Maintenance (Code C)	Cfg_FailT
Time to close seat when pulsing seat for cleaning (seconds)	Type a value (seconds) that the valve seat is held closed when pulsing for cleaning.		Cfg_PulseCloseT
Time to lift seat when pulsing seat for cleaning (sec)	Type a value (seconds) that the valve seat is held open when pulsing for cleaning.		Cfg_PulseOpenT

## Engineering Tab

The Engineering tab provides access to device configuration parameters and ranges, options for device and I/O setup, displayed text, and faceplate-to-faceplate navigation settings, and for initial system commissioning or later system changes.

The Engineering tab is divided into four pages.

### Engineering Tab Page 1

Page 1 of the Engineering tab lets you can enter descriptive strings and configure valve options.

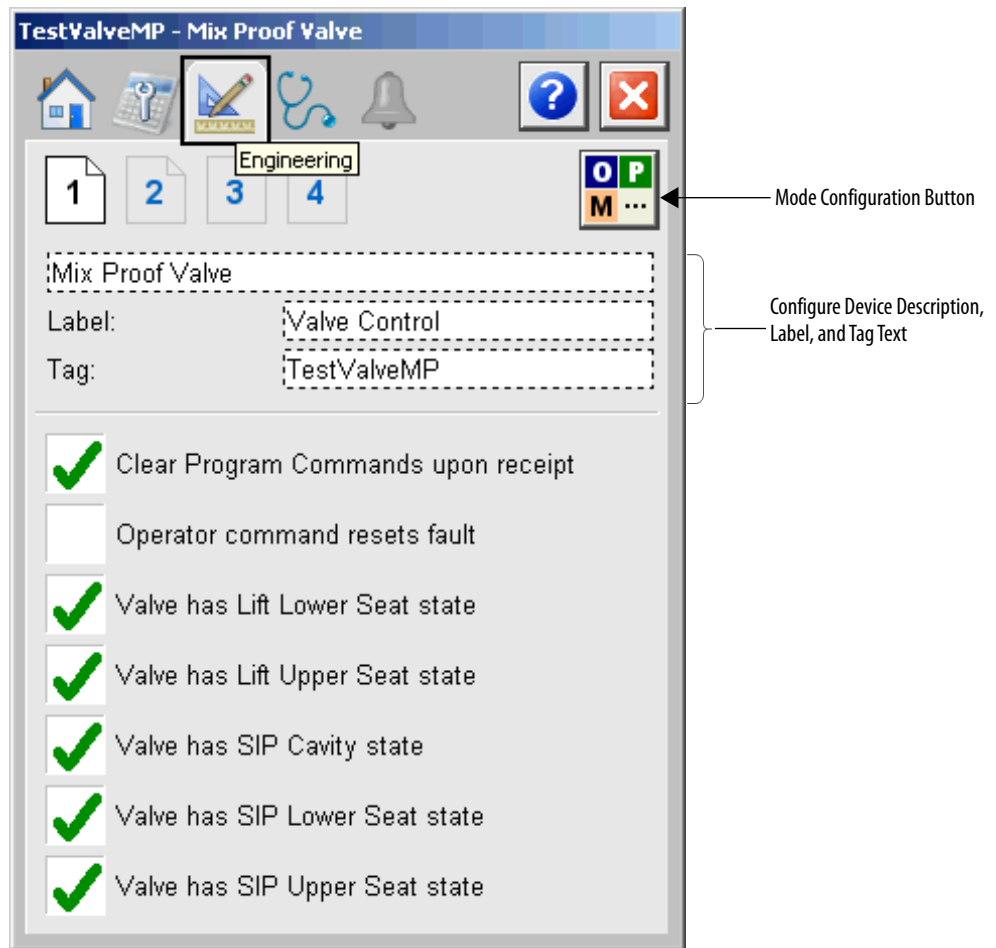

The following table lists the functions on page 1 of the Engineering tab.

**Table 14 - Engineering Tab Page 1 Description**

Function	Action	Security	Configuration Parameters
	Click to navigate to the Mode Configuration display.	None	See Mode Configuration Display on <a href="#">page 45</a>
Description	Type the device description to show on the faceplate title bar.	Engineering Configuration (Code E)	Cfg_Desc
Label	Type the label to show on the graphic symbol.		Cfg_Label
Tag	Type the tag name to show on the faceplate and tooltip. <b>TIP:</b> Pausing the mouse over this field displays a tool tip with the configured Logix tag/path.		Cfg_Tag
Clear Program Commands on receipt	Check to clear Program commands on receipt.		Cfg_PCmdClear
Operator command resets fault	Check to reset a fault on a new Operator command.		Cfg_OCmdResets
Valve has Lift Lower Seat state	Check to enable the lift lower seat state for the valve.		Cfg_HasLiftLower
Valve has Lift Upper Seat state	Check to enable the lift upper seat state for the valve.		Cfg_HasLiftUpper
Valve has SIP Cavity State	Check to enable the SIP cavity state for the valve.		Cfg_HasSIPCavity
Valve has SIP Lower Seat state	Check to enable the SIP lower seat state for the valve.		Cfg_HasSIPLower
Valve has SIP Upper Seat state	Check to enable the SIP upper seat state for the valve.		Cfg_HasSIPUpper

*Mode Configuration Display*

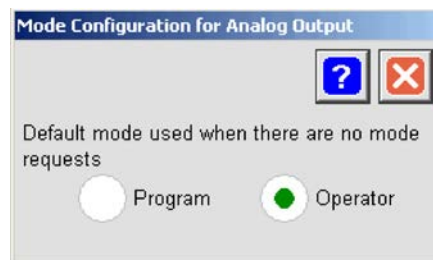

This display lets you select the default mode for the object by selecting the appropriate mode.

---

**IMPORTANT** If no mode is being requested, changing the default mode changes the mode of the instruction.

---

You must have FactoryTalk View security code E to select the default mode on this display.

Engineering Tab Page 2

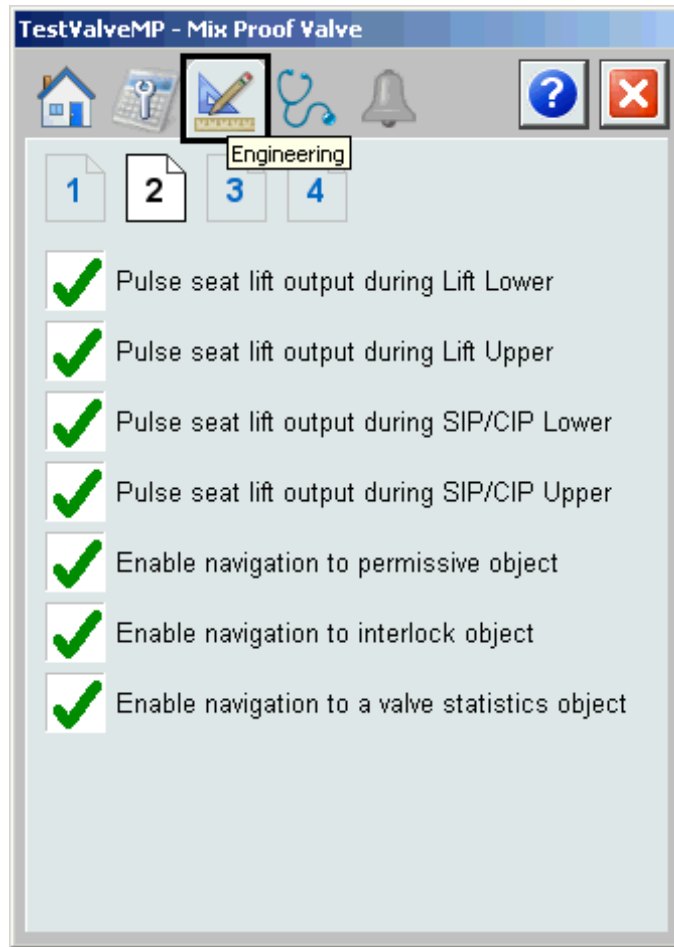

The following table shows the functions on page 2 of the Engineering tab.

**Table 15 - Engineering Tab Page 2 Description**

Function	Action	Security	Configuration Parameters
Pulse seat lift output during Lift Lower	Check to enable pulsing in the lift lower state.	Engineering Configuration (Code E)	Cfg_PulseLiftLower
Pulse seat lift output during Lift Upper	Check to enable pulsing in the lift upper state.		Cfg_PulseLiftUpper
Pulse seat lift output during SIP/CIP Lower	Check to enable pulsing in the SIP/CIP lower state.		Cfg_PulseSIPLower
Pulse seat lift output during SIP/CIP Upper	Check to enable pulsing in the SIP/CIP upper state.		Cfg_PulseSIPUpper

**Table 15 - Engineering Tab Page 2 Description**

Function	Action	Security	Configuration Parameters
Enable navigation to permissive object	<p>Check if a Permissive object is used with this valve. This changes the Permissive indicator to a clickable button to open the Permissive faceplate.</p> <p><b>IMPORTANT:</b> The name of the Permissive object in the controller must be this object's name with the suffix '_Perm'. For example, if your P_ValveMP object has the name 'ValveMP123', then its Permissive object must be named 'ValveMP123_Perm'.</p>	Engineering Configuration (Code E)	Cfg_HasPermObj
Enable navigation to interlock object	<p>Check if an Interlock object is used with this valve. This changes the Interlock indicator to a clickable button to open the Interlock faceplate.</p> <p><b>IMPORTANT:</b> The name of the interlock object in the controller must be this object's name with the suffix '_Intlk'. For example, if your P_ValveMP object has the name 'ValveMP123', then its interlock object must be named 'ValveMP123_Intlk'.</p>		Cfg_HasIntlkObj
Enable navigation to valve statistics object	<p>Check if the Valve Stats instruction (e.g. P_ValveStats) is used with this device. This adds a button to the faceplate that opens the Valve Stats faceplate.</p> <p><b>IMPORTANT:</b> The name of the Valve Statistics object in the controller must be this object's name with the suffix '_ValveStats'. For example, if your P_ValveMP object has the name 'ValveMP123', then its Interlock object must be named 'ValveMP123_ValveStats'.</p>		Cfg_HasStatsObj

Engineering Tab Page 3

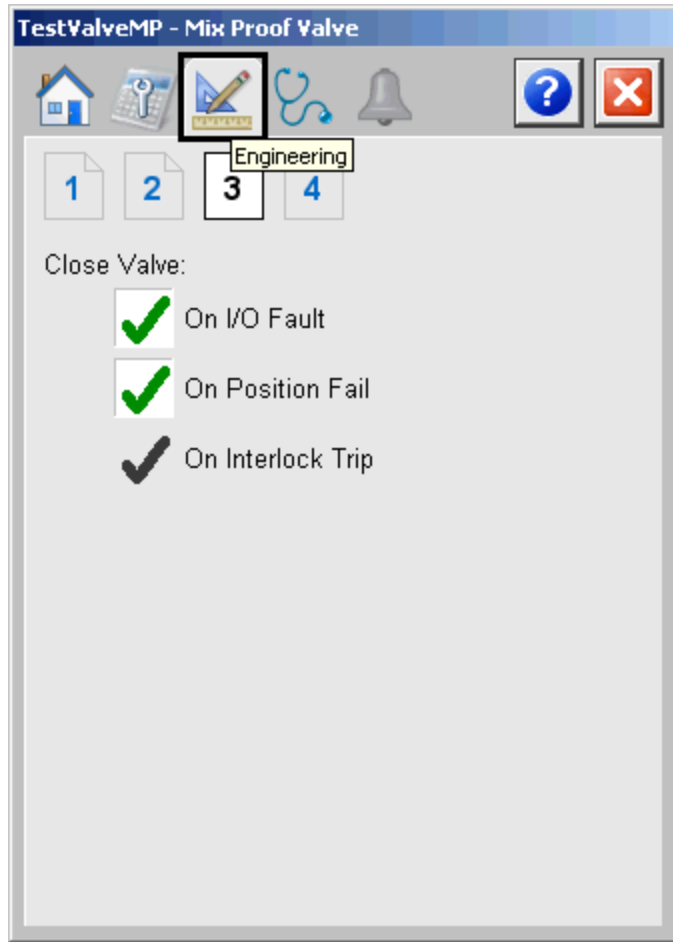

The following table shows the functions on page 3 of the Engineering tab.

**Table 16 - Engineering Tab Page 3 Description**

Function	Action	Security	Configuration Parameters
Close Valve: On I/O Fault	Check to close the valve when an I/O Fault occurs. A reset is required to clear this latched shed condition. Clear this checkbox to show only the I/O fault status/alarm and not trip the valve if an I/O fault is detected.	Engineering Configuration (Code E)	Cfg_ShedOnIOFault
Close Valve: On Position Fail	Check to close the valve when a Position Fail occurs. A reset is required to clear this latched shed condition. Clear this checkbox to show only the Position Fail status/alarm and not trip the valve if a Position Fail is detected.		Cfg_ShedOnFail
Close Valve: On Interlock Trip	The device always sheds (closes) on an interlock trip. This item cannot be unchecked. It is displayed as a reminder that the interlock trip function always triggers a shed.		None



Engineering Tab Page 4

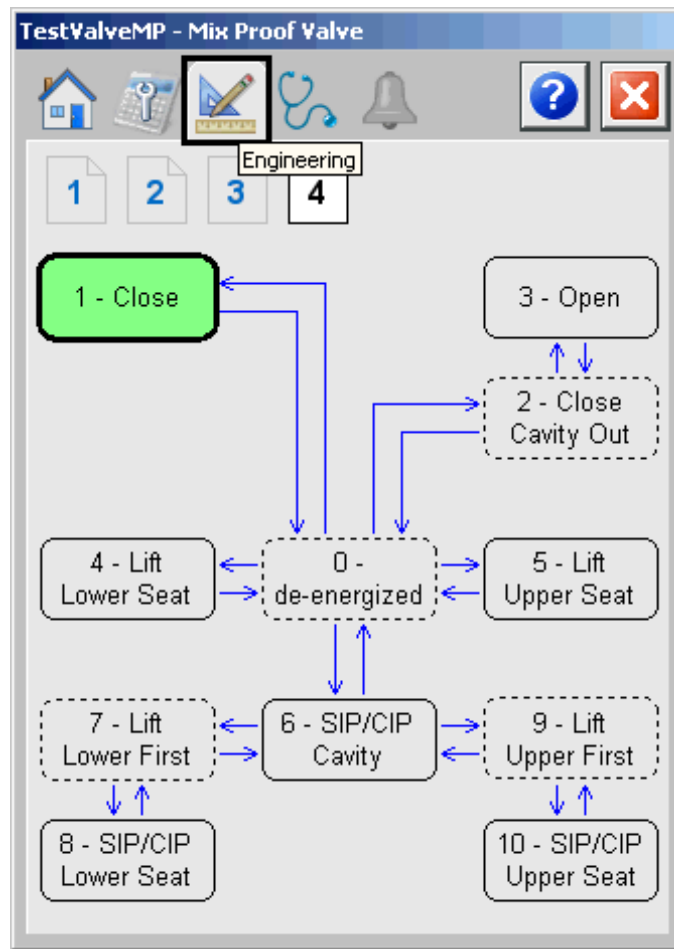

The following table shows the functions on page 4 of the Engineering tab.

**Table 17 - Engineering Tab Page 4 Description**

Function	Action	Security
State Configuration	Click a state box to open the State Configuration display to access configuration parameters for the valve state. See <a href="#">page 50</a> .	None

### State Configuration Display

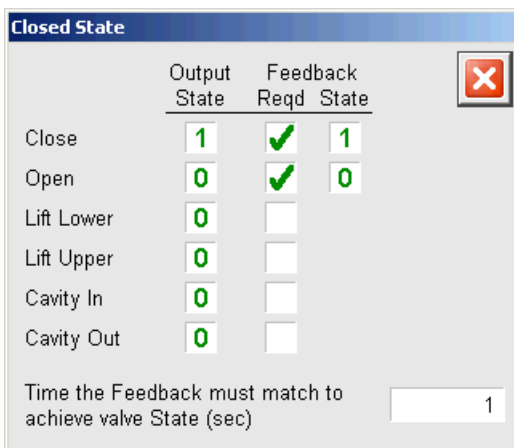

The following table explains the State Configuration display.

**Table 18 - State Configuration Display Description**

Function	Action	Security	Configuration Parameters
Output State	Set State of each Output in the selected valve state.	Engineering Configuration (Code E)	Cfg_OutStateTbl[x].y where x is a state number and y is an output number: 0 = Close 1 = Open 2 = Lift Lower 3 = Lift Upper 4 = Cavity In 5 = Cavity Out
Feedback Required	Check to require a feedback signals for the selected valve state.		Cfg_FdbkReqdTbl[x].y where x and y are the same as above.
Feedback State	Sets the desired value of the feedback signals for the selected valve state.		Cfg_FdbkStateTbl[x].y where x and y are the same as above.
Time the Feedback must match to achieve valve State (sec)	Type a value (seconds) the feedback must match for the valve to achieve the selected state.	Configuration and Tuning Maintenance (Code D)	Cfg_FdbkTimeTbl[x] where x is the same as above.

## Diagnostics Tab

The Diagnostic tab provides indications helpful in diagnosing or preventing device problems, which can include specific reasons a device is 'Not Ready', device warnings and faults, warning and fault history, and predictive/preventive maintenance data.

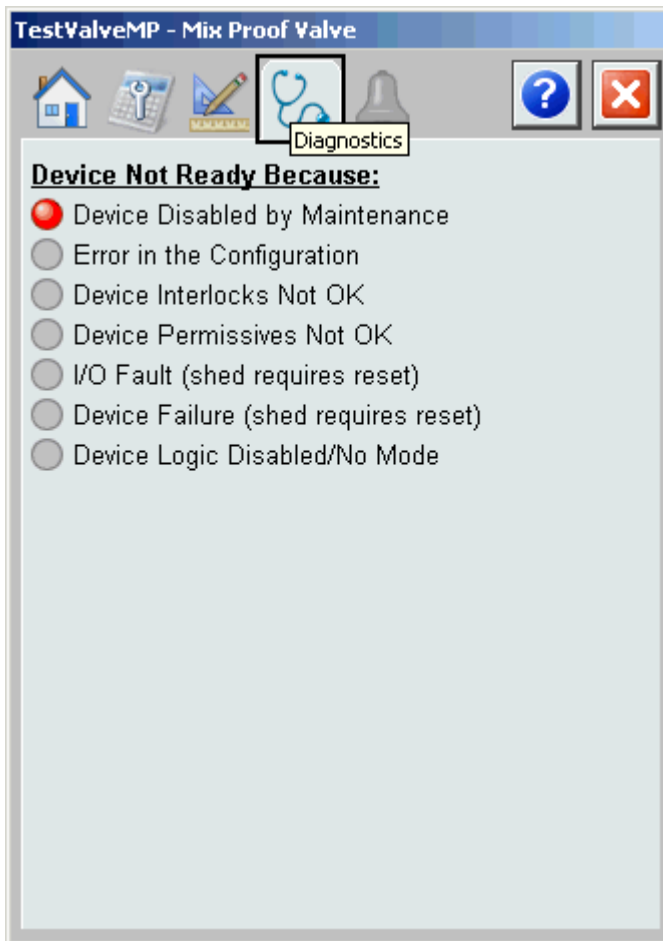

The previous figure shows that the valve is not ready because the device has been disabled by Maintenance.

## Alarms Tab

The Alarms tab displays each configured alarm for the P\_ValveMP instruction. The icon on the tab for the alarms page changes color based on the current active alarms. A blinking alarm icon indicates that one or more alarms must be acknowledged or the device must be reset.

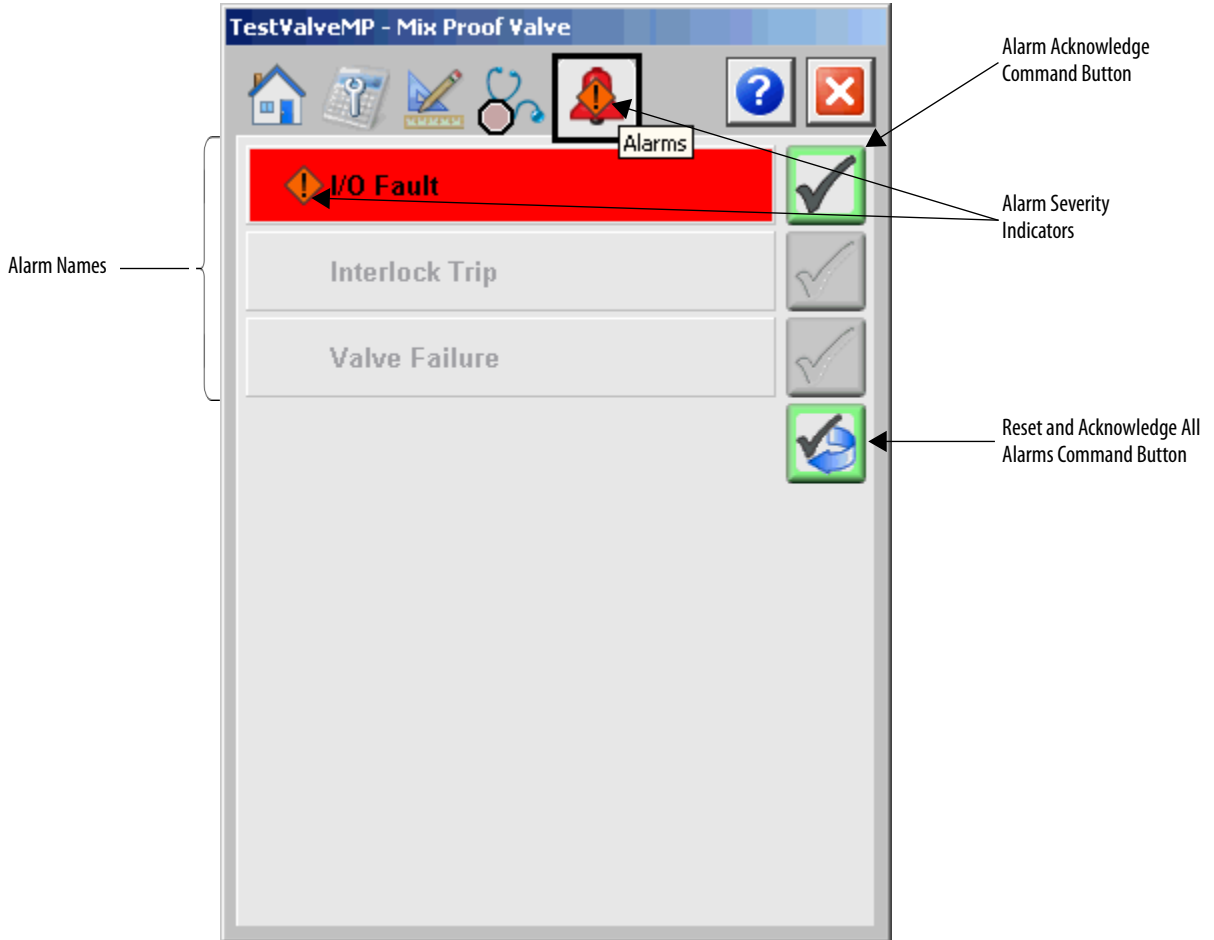

Click an alarm name to open the P\_Alarm faceplate for that alarm. From the P\_Alarm faceplate, you can configure and perform additional operations on the alarm.



If an alarm is active, the panel behind the alarm changes color to match the severity of the alarm. The color of the bell icon at the top of the faceplate shows the severity of the highest active alarm, and the icon blinks if any alarm is unacknowledged or requires reset.

**Table 19 - Alarm Severity Colors**

Color	Definition
Magenta	Urgent
Red	High
Yellow	Medium
Blue	Low
White (bell icon)	Alarm has cleared but is unacknowledged
Background (Light Gray)	No alarm

The following table shows the functions on the Alarms tab.

**Table 20 - Alarms Tab Description**

Function	Action	Security
Alarm Name	Click an alarm name to open the associated P_Alarm faceplate.	None
	Click to acknowledge the alarm.	Acknowledge Alarms (Code F)
	Click to reset and acknowledge all alarms.	

When the Reset and Acknowledge All Alarms button is enabled, the panel behind the alarm blinks, indicating the alarm requires acknowledgement or reset. The Alarm Acknowledge button is enabled if the alarm requires acknowledgment. Click the button with the check mark to acknowledge the alarm.

See Rockwell Automation Library of Process Objects: Common Alarm Block (P\_Alarm) Reference Manual, publication [SYSLIB-RM002](#), for more information.

## Mix-proof Valve Faceplate Help

The Faceplate Help is divided into two pages.

### Faceplate Help Page 1

**Mix-Proof Valve Faceplate Help**

1 2

**Status Indicators**

- Invalid Configuration
- Communication Failure
- Communication Uncertain
- The Device is Not Ready To Operate
- Alarm Inhibit (Suppressed or Disabled)
- A Maintenance Bypass is Active
- Device in Simulation or Test
- Device has been Disabled

**Mode Indicators**

- Device in Program Mode
- Device in Maintenance Mode
- Override
- Device in Operator Mode
- No Mode (Out of Service)
- Hand (Local)

**Interlocks and Permissives**

- One or more conditions not OK
- Non-Bypassed conditions OK
- All conditions OK, Bypass Active
- All conditions OK
- Enable checking all Interlock and Permissive conditions
- Bypass Interlocks and Permissives that can be bypassed

### Faceplate Help Page 2

**Mix-Proof Valve Faceplate Help**

1 2

**Commands**

- Open Valve. Available in Operator or Maintenance Mode
- Close Valve. Available in Operator or Maintenance Mode
- Lift Valve Lower Seat. Available in Operator or Maintenance Mode
- Lift Valve Upper Seat. Available in Operator or Maintenance Mode
- SIP/CIP Valve Lower Seat. Available in Operator or Maintenance Mode
- SIP/CIP Valve Upper Seat. Available in Operator or Maintenance Mode
- SIP/CIP Valve Cavity. Available in Operator or Maintenance Mode

**Alarms**

**Valve Fail Alarm**  
The Valve Fail alarm occurs when the valve fails to move to the commanded position.

**I/O Fault Alarm**  
The I/O Fault Alarm is triggered when a controller hardware or communication fault is detected.

**Interlock Trip Alarm**  
The Interlock Trip Alarm is triggered when an interlock condition causes the valve to return to its fail safe state.



## Rockwell Automation Support

Rockwell Automation provides technical information on the Web to assist you in using its products.

At <http://www.rockwellautomation.com/support> you can find technical and application notes, sample code, and links to software service packs. You can also visit our Support Center at <https://rockwellautomation.custhelp.com/> for software updates, support chats and forums, technical information, FAQs, and to sign up for product notification updates.

In addition, we offer multiple support programs for installation, configuration, and troubleshooting. For more information, contact your local distributor or Rockwell Automation representative, or visit <http://www.rockwellautomation.com/services/online-phone>.

## Installation Assistance

If you experience a problem within the first 24 hours of installation, review the information that is contained in this manual. You can contact Customer Support for initial help in getting your product up and running.

United States or Canada	1.440.646.3434
Outside United States or Canada	Use the <a href="#">Worldwide Locator</a> at <a href="http://www.rockwellautomation.com/rockwellautomation/support/overview.page">http://www.rockwellautomation.com/rockwellautomation/support/overview.page</a> , or contact your local Rockwell Automation representative.

## New Product Satisfaction Return

Rockwell Automation tests all of its products to help ensure that they are fully operational when shipped from the manufacturing facility. However, if your product is not functioning and needs to be returned, follow these procedures.

United States	Contact your distributor. You must provide a Customer Support case number (call the phone number above to obtain one) to your distributor to complete the return process.
Outside United States	Please contact your local Rockwell Automation representative for the return procedure.

## Documentation Feedback

Your comments will help us serve your documentation needs better. If you have any suggestions on how to improve this document, complete this form, publication [RA-DU002](#), available at <http://www.rockwellautomation.com/literature/>.

Rockwell Automation maintains current product environmental information on its website at <http://www.rockwellautomation.com/rockwellautomation/about-us/sustainability-ethics/product-environmental-compliance.page>.

Rockwell Otomasyon Ticaret A.Ş., Kar Plaza İş Merkezi E Blok Kat:6 34752 İçerenköy, İstanbul, Tel: +90 (216) 5698400

**[www.rockwellautomation.com](http://www.rockwellautomation.com)**

### Power, Control and Information Solutions Headquarters

Americas: Rockwell Automation, 1201 South Second Street, Milwaukee, WI 53204-2496 USA, Tel: (1) 414.382.2000, Fax: (1) 414.382.4444  
Europe/Middle East/Africa: Rockwell Automation NV, Pegasus Park, De Kleetlaan 12a, 1831 Diegem, Belgium, Tel: (32) 2 663 0600, Fax: (32) 2 663 0640  
Asia Pacific: Rockwell Automation, Level 14, Core F, Cyberport 3, 100 Cyberport Road, Hong Kong, Tel: (852) 2887 4788, Fax: (852) 2508 1846

Publication SYSLIB-RM035E-EN-P - February 2017

Supersedes Publication SYSLIB-RM035D-EN-P - January 2016

Copyright © 2017 Rockwell Automation, Inc. All rights reserved. Printed in the U.S.A.