

Rockwell Automation Library of Process Objects: Analog/ Pulsed Control Valve (P_ValveC)

Version 3.5

IMPORTANT

This manual applies to the Rockwell Automation Library of Process Objects version 3.5 or earlier.
For Rockwell Automation Library of Process Objects version 5.0, see

- [PROCES-RM200](#)

For Rockwell Automation Library of Process Objects version 4.0 or later, use the following manuals:

- [PROCES-RM013](#) contains logic instructions
- [PROCES-RM014](#) contains display elements



Important User Information

Read this document and the documents listed in the additional resources section about installation, configuration, and operation of this equipment before you install, configure, operate, or maintain this product. Users are required to familiarize themselves with installation and wiring instructions in addition to requirements of all applicable codes, laws, and standards.

Activities including installation, adjustments, putting into service, use, assembly, disassembly, and maintenance are required to be carried out by suitably trained personnel in accordance with applicable code of practice.

If this equipment is used in a manner not specified by the manufacturer, the protection provided by the equipment may be impaired.

In no event will Rockwell Automation, Inc. be responsible or liable for indirect or consequential damages resulting from the use or application of this equipment.

The examples and diagrams in this manual are included solely for illustrative purposes. Because of the many variables and requirements associated with any particular installation, Rockwell Automation, Inc. cannot assume responsibility or liability for actual use based on the examples and diagrams.

No patent liability is assumed by Rockwell Automation, Inc. with respect to use of information, circuits, equipment, or software described in this manual.

Reproduction of the contents of this manual, in whole or in part, without written permission of Rockwell Automation, Inc., is prohibited.

Throughout this manual, when necessary, we use notes to make you aware of safety considerations.



WARNING: Identifies information about practices or circumstances that can cause an explosion in a hazardous environment, which may lead to personal injury or death, property damage, or economic loss.



ATTENTION: Identifies information about practices or circumstances that can lead to personal injury or death, property damage, or economic loss. Attentions help you identify a hazard, avoid a hazard, and recognize the consequence.

IMPORTANT

Identifies information that is critical for successful application and understanding of the product.

Labels may also be on or inside the equipment to provide specific precautions.



SHOCK HAZARD: Labels may be on or inside the equipment, for example, a drive or motor, to alert people that dangerous voltage may be present.



BURN HAZARD: Labels may be on or inside the equipment, for example, a drive or motor, to alert people that surfaces may reach dangerous temperatures.



ARC FLASH HAZARD: Labels may be on or inside the equipment, for example, a motor control center, to alert people to potential Arc Flash. Arc Flash will cause severe injury or death. Wear proper Personal Protective Equipment (PPE). Follow ALL Regulatory requirements for safe work practices and for Personal Protective Equipment (PPE).

**Analog/Pulsed Control Valve
(P_ValveC)**

Preface

Software Compatibility and Content Revision.....	5
Additional Resources.....	5
Guidelines.....	7
Functional Description.....	8
Required Files.....	10
Controller File.....	10
Visualization Files.....	10
Controller Code.....	13
Analog/Pulsed Control Valve Input Structure.....	13
Analog/Pulsed Control Valve Output Structure.....	17
Analog/Pulsed Control Valve Local Configuration Tags.....	21
Operations.....	22
Modes.....	22
Alarms.....	22
Simulation.....	23
Execution.....	23
Programming Examples.....	24
Example 1: Manual Loading Station.....	24
Example 2: Ratcheting Control Valve.....	25
Display Elements.....	27
Status/Quality Indicators.....	28
Mode Indicators.....	29
Alarm Indicators.....	30
Maintenance Bypass Indicator.....	30
Using Display Elements.....	31
Quick Display.....	33
Faceplate.....	33
Operator Tab.....	34
Maintenance Tab.....	39
Engineering Tab.....	45
Diagnostics Tab.....	51
Alarms Tab.....	52
Analog/Pulsed Control Valve Faceplate Help.....	54

Notes:

Software Compatibility and Content Revision

Table 1 - Summary of Changes

Topic	Page
Visualization Files: Global Objects (.ggfx) - Process Diagnostic Objects Corrected	11

For the latest compatible software information and to download the Rockwell Automation® Library of Process Objects, see the Product Compatibility and Download Center at <http://www.rockwellautomation.com/rockwellautomation/support/pcdc.page>.

For general library considerations, see Rockwell Automation Library of Process Objects, publication [PROCES-RM002](#).

Additional Resources

These documents contain additional information concerning related products from Rockwell Automation.

Resource	Description
PlantPax® Distributed Control System Selection Guide, publication PROCES-SG001	Provides information to assist with equipment procurement for your PlantPax system.
PlantPax Distributed Control System Reference Manual, publication PROCES-RM001	Provides characterized recommendations for implementing your PlantPax system.
Rockwell Automation Library of Process Objects, publication PROCES-RM002	Provides general considerations for the PlantPax system library of process objects.
FactoryTalk® View Machine Edition User Manual, publication VIEWME-UM004	Provides details on how to use this software package for creating an automation application.
FactoryTalk View Site Edition User Manual, publication VIEWSE-UM006	Provides details on how to use this software package for developing and running human-machine interface (HMI) applications that can involve multiple users and servers, distributed over a network.
Logix5000™ Controllers Add On Instructions Programming Manual, publication 1756-PM010	Provides information for designing, configuring, and programming Add-On Instructions.
Rockwell Automation Library of Process Objects Common Alarm Block (P_Alarm) Reference Manual, publication SYSLIB-RM002	Details how to monitor an input condition to raise an alarm. Information includes acknowledging, resetting, inhibiting, and disabling an alarm.
Rockwell Automation Library of Process Objects: Interlocks with First Out and Bypass (P_Intlk) Reference Manual, publication SYSLIB-RM004	Explains how to collect (sum up) the interlock conditions that stop or de-energize a running or energized piece of equipment or prevent it from starting or being energized.
Rockwell Automation Library of Process Objects Common Mode Block (P_Mode) Reference Manual, publication SYSLIB-RM005	Explains how to select the Mode (owner) of an instruction or control strategy. The Mode instruction is usually embedded within other instructions to extend their functionality. It is possible to use a standalone Mode instruction to enhance a program where modes are wanted.

You can view or download publications at <http://www.rockwellautomation.com/literature/>. To order paper copies of technical documentation, contact your local Allen-Bradley distributor or Rockwell Automation sales representative.

Analog/Pulsed Control Valve (P_ValveC)

The P_ValveC (Analog/Pulsed Control Valve) Add-On Instruction manipulates a control valve by using an analog signal or discrete signals, and monitors the valve by using an analog position feedback. The global objects and following faceplate are examples of the graphical interface tools for this Add-On Instruction.

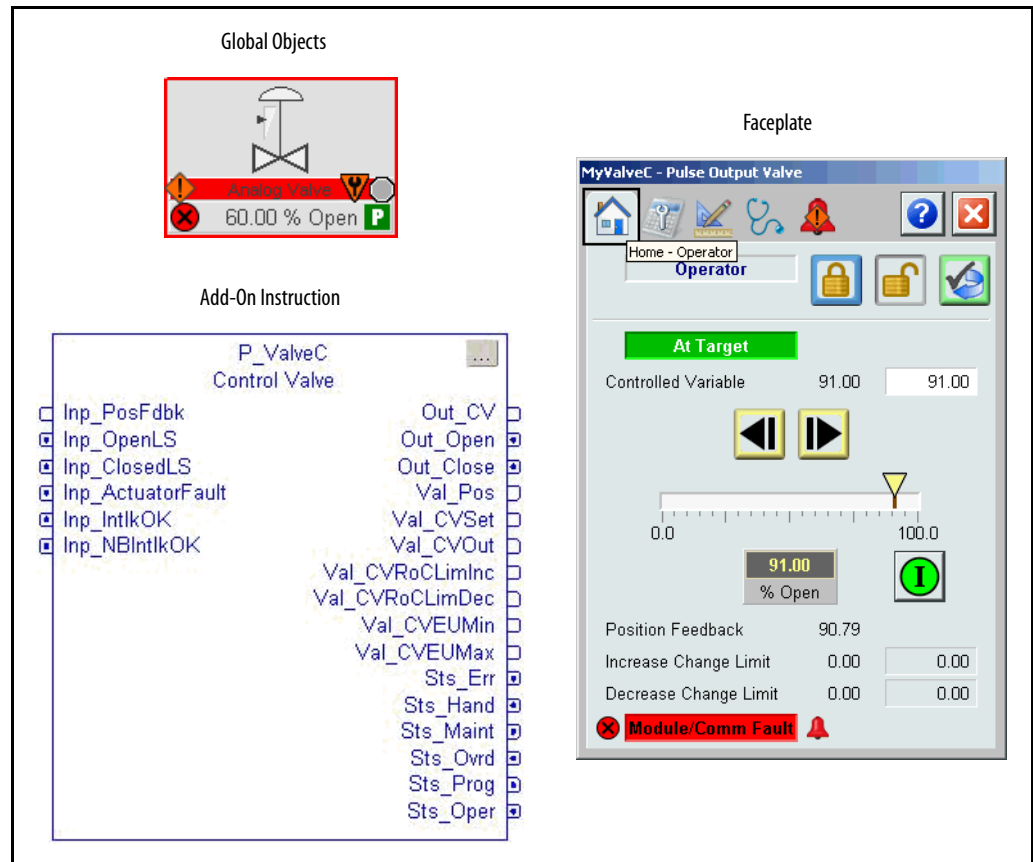

Guidelines

Use this instruction in these situations:

- You want to use a control (modulating) valve where 0...100% is mapped to the percentage open.
- The valve requires an analog output (or analog value over a network) for the target position, or the valve requires a pair of discrete outputs (or discrete signals over a network) to tell it when to move toward fully closed and when to move toward fully open. The discrete outputs can be held (for a motor-operated control valve) or pulsed (for a ratcheting control valve).
- If you use discrete outputs, and optionally if you use the analog output, the valve provides an actual position feedback signal.

Do **not** use this instruction in these situations:

- You are using a single analog output control valve with a PID loop (the P_PIDE Add-On Instruction or the PIDE built-in instruction). The CVEU signal can be used directly to drive the valve or you can use the P_AOut (Analog Output) Add-On Instruction.
- You are using a two-state valve, such as a motor-operated or solenoid-operated valve that is driven only fully open or fully closed and not used to control flow or pressure. Use the appropriate two-state valve instruction instead:
 - P_ValveMO for motor operated valve (also for a dual solenoid operated valve)
 - P_ValveSO for a single solenoid operated valve

Functional Description

The P_ValveC Instruction provides the following capabilities:

- Program and operator entry of the target valve position (percentage of the valve opening).
- Ramping of the valve position to the entered target at a specified rate of change (percent per second).
- Scaling of the Position Feedback from the valve from raw (I/O card or network value) units to percent open.
- Monitoring of Interlock conditions. When an Interlock condition is not OK, the valve can be configured to hold its current position or shed to a configured Interlock position.
- Monitoring for I/O communication faults. When an I/O communication fault occurs, this instruction can be configured to alarm only, or to shed, either to hold the current position or go to the configured Interlock position.
- Provides alarms for Interlock trip, I/O fault, or an actuator-declared fault.
- Provides full-open and full-closed status based on user-specified ranges for analog position feedback, or based on optional valve travel limit switches.
- Provides an 'available' status when the control valve instruction is in Program mode and the valve is capable of being controlled.

The diagram shows the functional characteristics of the P_ValveC Add-On Instruction.

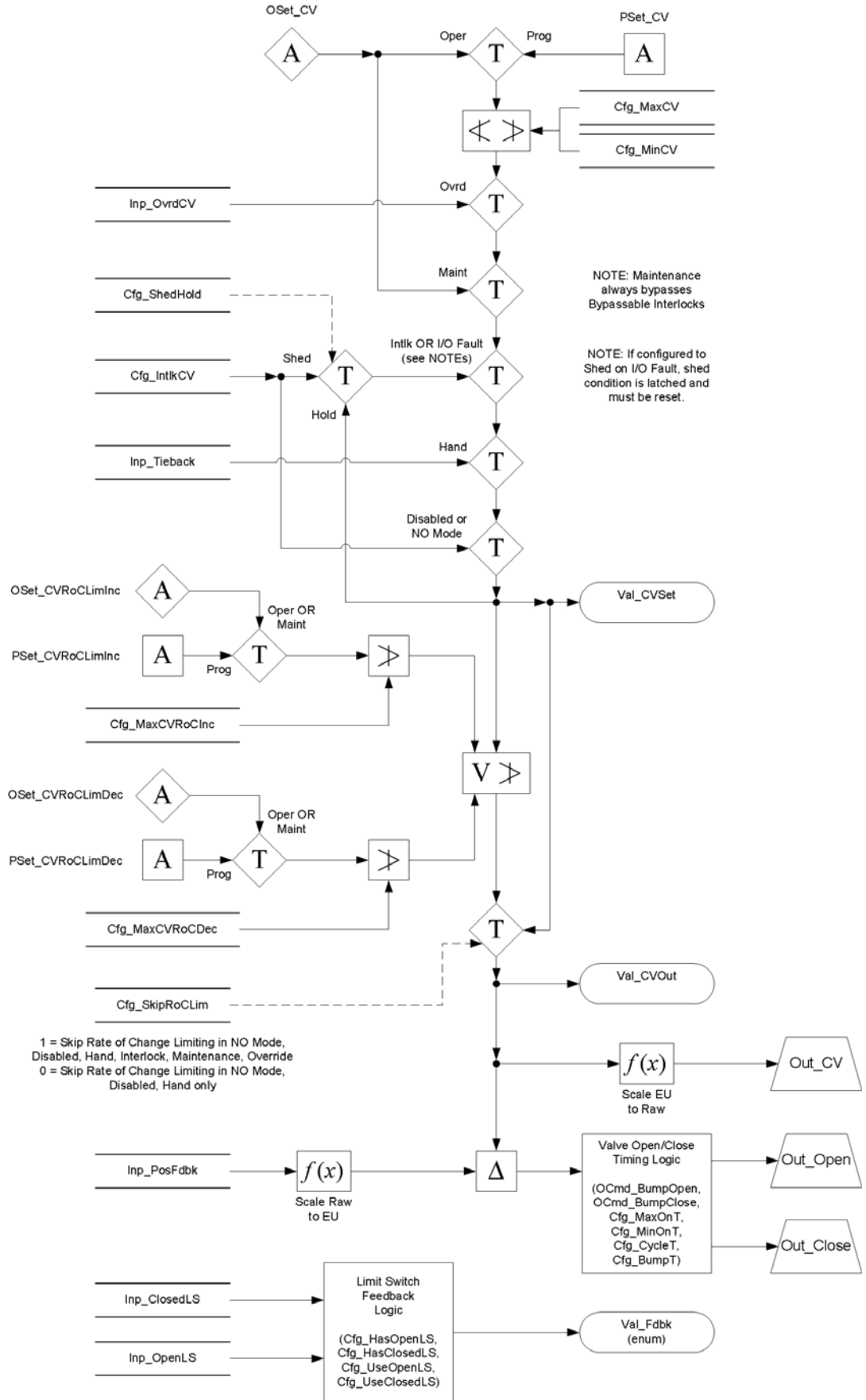

Required Files

Add-On Instructions are reusable code objects that contain encapsulated logic that can streamline implementing your system. This lets you create your own instruction set for programming logic as a supplement to the instruction set provided natively in the ControlLogix® firmware. An Add-On Instruction is defined once in each controller project, and can be instantiated multiple times in your application code as needed.

Controller File

The P_ValveC_3_5-00_AOIL5X Add-On Instruction must be imported into the controller project to be used in the controller configuration. The service release number (boldfaced) can change as service revisions are created.

Visualization Files

This Add-On Instruction has associated visualization files that provide a common user interface. These files can be downloaded from the Product Compatibility and Download Center at <http://www.rockwellautomation.com/rockwellautomation/support/pcdc.page>.

-
- IMPORTANT** The visualization file dependencies require Process Library content imports to occur in a specific order as reflected in the following tables:
- Images
 - Global Objects
 - Standard Displays
 - HMI Tags
 - Macros
-

Images are external graphic files that can be used in displays. They must be imported for FactoryTalk View to make use of them.

When PNG files are imported, they are renamed by FactoryTalk View with a .bmp file extension, but retain a .png format.

Table 2 - Visualization Files: Images (.png)

FactoryTalk View SE Software	FactoryTalk View ME Software	Description
All .png files in the images folder	All .png files in the images folder	These are the common icons used in the global objects and standard displays for all Process Objects.

The Global Object files (.ggfx file type) in the following table are Process Library display elements that are created once and referenced multiple times on multiple displays in an application. When changes are made to a Global Object, all instances in the application are automatically updated.

Table 3 - Visualization Files: Global Objects (.ggfx)

FactoryTalk View SE Software	FactoryTalk View ME Software	Description
(RA-BAS) Common Faceplate Objects	(RA-BAS-ME) Common Faceplate Objects	Global objects used on process object faceplates.

Table 3 - Visualization Files: Global Objects (.ggfx)

FactoryTalk View SE Software	FactoryTalk View ME Software	Description
(RA-BAS) Process Graphics Library	(RA-BAS-ME) Process Graphics Library	Process global object device symbols used to build process graphics.
(RA-BAS) Process Alarm Objects	(RA-BAS-ME) Process Alarm Objects	Global objects used for managing alarms on process object faceplates.
(RA-BAS) Process Diagnostic Objects	(RA-BAS-ME) Process Diagnostic Objects	Diagnostic global objects used on process object faceplates.
(RA-BAS) Process Faceplate Valve Objects	(RA-BAS-ME) Process Faceplate Valve Objects	Valve global objects used on process object faceplates.
(RA-BAS) Process Faceplate Analog Objects	(RA-BAS-ME) Process Faceplate Analog Objects	Analog global objects used on process object faceplates.
(RA-BAS) Process Help Objects	(RA-BAS-ME) Process Help Objects	Global objects used for all process objects help displays.
(RA-BAS) Process Interlock Objects	(RA-BAS-ME) Process Interlock Objects	Global objects used for managing interlocks and permissives on process object faceplates.
(RA-BAS) Process Mode Objects	(RA-BAS-ME) Process Mode Objects	Global objects used for managing modes on process object faceplates.

The Standard Display files (.gfx file type) in the following table are the Process Library displays that you see at runtime.

Table 4 - Visualization Files: Standard Displays (.gfx)

FactoryTalk View SE Software	FactoryTalk View ME Software	Description
(RA-BAS) Common-AnalogEdit	N/A	Faceplate used for analog input data entry. The FactoryTalk View ME faceplates use the native analog input data entry so no file is required.
(RA-BAS) P_Alarm-Faceplate	(RA-BAS-ME) P_Alarm-Faceplate	The faceplate that is used for managing alarms for the object.
(RA-BAS) P_Alarm-Help	(RA-BAS-ME) P_Alarm-Help	Alarm Help information that is accessed from the P_Alarm faceplate.
(RA-BAS) P_ValveC-Faceplate	(RA-BAS-ME) P_ValveC-Faceplate	The faceplate that is used for the object
(RA-BAS) P_ValveC-Quick	(RA-BAS-ME) P_ValveC-Quick	The Quick display that is used for the object
(RA-BAS) P_Mode-Config	(RA-BAS-ME) P_Mode-Config	The Configuration Display used to configure the P_Mode object.
(RA-BAS) Process Analog Family-Help	(RA-BAS-ME) Process Analog Family-Help	The Help display for Analog objects
(RA-BAS) P_Intlk-Faceplate	(RA-BAS-ME) P_Intlk-Faceplate	Optional The interlock faceplate used for the object. Use this file if your Control Valve has an associated P_Intlk object and you enable navigation to its faceplate from the Control Valve faceplate.
(RA-BAS) Process Interlock Family-Help	(RA-BAS-ME) Process Interlock Family-Help	Optional Interlock help display that is used for the object Use this file if you use the P_Intlk faceplate.

HMI Tags are created in a FactoryTalk View ME application to support tab switching on Process Library faceplates. The HMI tags may be imported via the comma-separated values file (.csv file type) in the following table.

Table 5 - Visualization Files: HMI Tags (.csv)

FactoryTalk View SE Software	FactoryTalk View ME Software	Description
N/A	FTVME_PlantPAXLib_Tags_3_5_XX.csv where XX = the service release number.	These tags must be imported into the FactoryTalk View ME project to support switching tabs on any Process Object faceplate.

In a FactoryTalk View SE application, a macro is a series of commands stored in a text file. In FactoryTalk View ME application, a macro is a list of tag assignments stored in a text file. The following table lists the Macros (.mcr file type) used by the Process Library.

Table 6 - Visualization Files: Macros (.mcr file)

FactoryTalk View SE Software	FactoryTalk View ME Software	Description
NavToP_LLS_Motor	N/A	This macro must be imported into the FactoryTalk View SE project to support navigation to the Motor faceplate from the P_LLS faceplate.

Controller Code

This section describes the parameter references for this Add-On Instruction.

Analog/Pulsed Control Valve Input Structure

Input parameters include the following:

- Input data elements (Inp_) are typically used to connect field inputs from I/O modules or signals from other objects.
- Configuration data elements (Cfg_) are used to set configurable capabilities and features of the instruction.
- Command data elements (PCmd_, OCmd_, MCmd_) are used by program logic, operators, and maintenance personnel to request instruction actions.
- Setting data elements (PSet_, OSet_) are used by program logic, operators, and maintenance personnel to establish runtime setpoints, thresholds, and so forth.

Table 7 - P_ValveC Input Parameters

Input Parameter	Data Type	Alias For	Default	Description
EnableIn	BOOL		1	<p>Ladder Diagram: If the rung-in condition is true, the instruction's Logic routine executes. If the rung-in condition is false, the instruction's EnableInFalse routine executes.</p> <p>Function Block Diagram: If true, or not connected, the instruction's Logic routine executes. If the parameter is exposed as a pin and wired, and the pin is false, the instruction's EnableInFalse routine executes.</p> <p>Structured Text: No effect. The instruction's Logic routine executes.</p>
Inp_PosFdbk	REAL		0.0	Position feedback from valve (in raw input units).
Inp_OpenLS	BOOL		0	Valve open limit switch. 1 = Confirmed fully open.
Inp_ClosedLS	BOOL		0	Valve closed limit switch. 1 = Confirmed fully closed.
Inp_ActuatorFault	BOOL		0	Valve actuator fault (overload, and so forth): 0 = OK 1 = Fault
Inp_IntlkOK	BOOL		1	1 = Interlocks OK, pulse output valve can be moved.
Inp_NBIntlkOK	BOOL		1	1 = Non-bypassable interlocks OK, pulse output valve can be moved.
Inp_IOFault	BOOL		0	Input/output communication status: 0 = OK 1 = Fail
Inp_Sim	BOOL		0	Simulation input. When set to 1, the instruction holds the analog output at zero and holds the discrete pulse outputs off while simulating a working valve. When set to 0, the instruction controls the valve position normally.
Inp_Hand	BOOL	Mode.Inp_Hand	0	1 = Select Hand (hard-wired) mode.
Inp_Ovr	BOOL	Mode.Inp_Ovr	0	1 = Select override (Ovr) mode.
Inp_OvrCV	REAL		0.0	CV target in Override mode (CV engineering units).
Inp_Reset	BOOL		0	Input parameter used to programatically reset alarms. When set to 1, all alarms requiring reset are reset.

Table 7 - P_ValveC Input Parameters

Input Parameter	Data Type	Alias For	Default	Description
Cfg_ShedHold	BOOL		0	1 = Hold output on interlock or bad CV. 0 = Go to Cfg_IntlkCV.
Cfg_ShedOnIOFault	BOOL		0	1 = Take shed action (hold or interlock CV) and alarm on I/O Fault. 0 = Alarm only on I/O Fault. IMPORTANT: If a condition is configured to shed the device on a fault, a reset is required to clear the shed fault to command the device.
Cfg_SkipRoCLim	BOOL		0	1 = Skip Rate of Change limiting in Interlock, Maintenance, Override modes.
Cfg_SetTrack	BOOL		1	This parameter is used to set up bumpless behavior of setting parameters when switching modes. When this parameter is 1, in Program mode the operator settings track the program settings; in Operator mode the program settings track the operator settings; and the simulation inputs match the output values (transitions are bumpless). When this parameter is 0, the operator settings and program settings are not modified by this instruction. In this case, when the mode is changed, the effective value of the setting can change depending on the program-set and operator-set values.
Cfg_SetTrackOvrHand	BOOL		0	1 = Program/operator settings track override/hand CV.
Cfg_HasOpenLS	BOOL		0	1 = Valve provides an open limit switch signal.
Cfg_HasClosedLS	BOOL		0	1 = Valve provides a closed limit switch signal.
Cfg_UseOpenLS	BOOL		0	1 = Valve Open LS - use for open/closed status.
Cfg_UseClosedLS	BOOL		0	1 = Valve Closed LS - use for open/closed status.
Cfg_LSFail	BOOL		1	1 = Both switches On = fail. 0 = Both switches Off = fail.
Cfg_HasIntlkObj	BOOL		0	1 = Tells HMI an interlock object (for example, P_Intlk) is used for Inp_IntlkOK and navigation to the interlock object's faceplate is enabled. IMPORTANT: The name of the interlock object in the controller must be this object's name with the suffix '_Intlk'. For example, if your P_ValveC object has the name 'ValveC123', then its interlock object must be named 'ValveC123_Intlk'.
Cfg_HasCVNav	BOOL		0	1 = Tells HMI to enable navigation to a connected CV object.
Cfg_PCmdClear	BOOL	Mode.Cfg_PCmdClear	1	When this parameter is 1, program commands are cleared once they are acted upon. When set to 0, program commands remain set until cleared by the application program logic. IMPORTANT: Clearing this parameter online can cause unintended program command execution.
Cfg_ProgDefault	BOOL	Mode.Cfg_ProgDefault	0	This parameter defines the default mode. When this parameter is 1, the mode defaults to Program if no mode is being requested. When this parameter is 0, the mode defaults to Operator if no mode is being requested. IMPORTANT: Changing this parameter online can cause unintended mode changes.
Cfg_OvrIntlk	BOOL		0	1 = Override ignores bypassable interlock. 0 = Override mode uses all interlocks.
Cfg_HasIntlkTripAlm	BOOL	IntlkTrip.Cfg_Exists	0	These parameters determine whether the corresponding alarm exists and is checked or if the alarm does not exist and is not used. When these parameters are 1, the corresponding alarm exists.
Cfg_HasActuatorFaultAlm		ActuatorFault.Cfg_Exists		
Cfg_HasIOFaultAlm		IOFault.Cfg_Exists		

Table 7 - P_ValveC Input Parameters

Input Parameter	Data Type	Alias For	Default	Description
Cfg_IntlkTripResetReqd	BOOL	IntlkTrip.Cfg_ResetReqd	0	These parameters determine whether a reset is required to clear the alarm status. When these parameters are 1, the alarm is latched ON when the alarm occurs. After the alarm condition returns to normal, a reset is required to clear the alarm status (for example, OCmd_Reset, Inp_Reset, or IOFault.OCmd_Reset are required to clear Alm_IOFault alarm after the alarm is set and the value returns to normal). When these parameters are 0, no reset is required and the alarm status is cleared when the alarm condition returns to normal. IMPORTANT: If the reset clears the alarm, it also acknowledges the alarm.
Cfg_ActuatorFaultResetReqd		ActuatorFault.Cfg_ResetReqd		
Cfg_IOFaultResetReqd		IOFault.Cfg_ResetReqd		
Cfg_IntlkTripAckReqd	BOOL	IntlkTrip.Cfg_AckReqd	1	These parameters determine whether an acknowledgement is required for an alarm. When these parameters are 1, the acknowledge (ack) bit is cleared when the alarm occurs. An acknowledge command (for example, PCmd_IOFaultAck or IOFault.OCmd_Ack) are required to acknowledge the alarm. When set to 0, the Acknowledge bit is set when an alarm occurs indicating an acknowledged alarm and no acknowledge command is required.
Cfg_ActuatorFaultAckReqd		ActuatorFault.Cfg_AckReqd		
Cfg_IOFaultAckReqd		IOFault.Cfg_AckReqd		
Cfg_IntlkTripSeverity	INT	IntlkTrip.Cfg_Severity	500	These parameters determine the severity of each alarm that gauges the color and symbol that are used to indicate alarm status on the faceplate and global object. The following are valid values: 1...250 = Low 251...500 = Medium 501...750 = High 751...1000 = Urgent IMPORTANT: For FactoryTalk View software, version 7.0, these severity priorities drive only the indication on the global object and faceplate. The Alarm & Events definition severity drives the color and symbol that is used on the alarm banner and alarm summary as well as the value returned by the FactoryTalk Alarm and Events software display commands.
Cfg_ActuatorFaultSeverity		ActuatorFault.Cfg_Severity	1000	
Cfg_IOFaultSeverity		IOFault.Cfg_Severity	1000	
Cfg_MinCV	REAL		0.0	Minimum CV (in CV engineering units, for limiting).
Cfg_MaxCV	REAL		100.0	Maximum CV (in CV engineering units, for limiting).
Cfg_MaxCVRoCInc	REAL		10.0	Maximum allowed CV Rate of Change (increasing) setting (engineering units/second).
Cfg_MaxCVRoCDec	REAL		10.0	Maximum allowed CV Rate of Change (decreasing) setting (engineering units/second).
Cfg_IntlkCV	REAL		0.0	CV (target in engineering units) when interlocked (used when Cfg_ShedHold is configured to 0).
Cfg_CVEUMin	REAL		0.0	These parameters must be set to the range of the signal connected to the setting inputs (for example, PSet_CV). The output is then scaled to the values set by Cfg_CVRawMin and Cfg_CVRawMax.
Cfg_CVEUMax			100.0	
Cfg_CVRawMin	REAL		0.0	These parameters must be set to match the CV range of the output signals (Out_CV) in raw units. EXAMPLE: If your output card expects a value in the range of 4...20 and the P_ValveC's CV is ranged 0...100%, P_ValveC can scale the outputs for you by setting Cfg_CVRawMin to 4, Cfg_CVRawMax to 20, Cfg_CVEUMin to 0, and Cfg_CVEUMax to 100.
Cfg_CVRawMax			100.0	
Cfg_FdbkRawMin	REAL		0.0	These parameters must be set to the range of the signal connected to the feedback signal (Inp_PosFdbk). The inputs are then scaled to the values set by Cfg_CVEUMin and Cfg_CVEUMax.
Cfg_FdbkRawMax			100.0	
Cfg_CycleT	REAL		10.0	Open and close pulse output overall period (seconds).
Cfg_OpenRate	REAL		1.0	Rate at which valve moves when opening (CV engineering units/second).
Cfg_CloseRate	REAL		1.0	Rate at which valve moves when closing (CV engineering units/second).
Cfg_MaxOnT	REAL		5.0	Open and close pulse output maximum on time (seconds).
Cfg_MinOnT	REAL		1.0	Open and close pulse output minimum on time (seconds).

Table 7 - P_ValveC Input Parameters

Input Parameter	Data Type	Alias For	Default	Description
Cfg_BumpT	REAL		0.0	Time to bump valve open or closed (by operator) when feedback bad (seconds).
Cfg_Deadtime	REAL		0.0	Additional time on first pulse after stop or direction change.
Cfg_MaxClosedPos	REAL		0.0	Position above which valve is assumed open if limit switches are not used.
PSet_CV	REAL		0.0	Program setting of controlled variable (output) (CV engineering units).
PSet_CVRoCLimInc	REAL		0.0	Program setting of CV Rate of Change limit, increasing (in engineering units/second).
PSet_CVRoCLimDec	REAL		0.0	Program setting of CV Rate of Change limit, decreasing (in engineering units/second).
PSet_Owner	DINT		0.0	Program owner Request ID (non-zero) or Release (zero).
OSet_CV	REAL		0.0	Operator setting of controlled variable (output) (CV engineering units).
OSet_CVRoCLimInc	REAL		0.0	Operator setting of CV Rate of Change limit, increasing (in engineering units/second).
OSet_CVRoCLimDec	REAL		0.0	Operator setting of CV Rate of Change limit, decreasing (in engineering units/second).
PCmd_Acq	BOOL	Mode.PCmd_Acq	0	When Cfg_PCmdClear is 1: <ul style="list-style-type: none"> Set PCmd_Acq to 1 to Acquire Set PCmd_Rel to 1 to Release These parameters reset automatically When Cfg_PCmdClear is 0: <ul style="list-style-type: none"> Set PCmd_Acq to 1 to Acquire Set PCmd_Acq to 0 to Release PCmd_Rel is not used These parameters do not reset automatically
PCmd_Rel		Mode.PCmd_Rel		
PCmd_Lock	BOOL	Mode.PCmd_Lock	0	When Cfg_PCmdClear is 1: <ul style="list-style-type: none"> Set PCmd_Lock to 1 to Lock Set PCmd_Unlock to 1 to Unlock These parameters reset automatically When Cfg_PCmdClear is 0: <ul style="list-style-type: none"> Set PCmd_Lock to 1 to Lock Set PCmd_Lock to 0 to Unlock PCmd_Unlock is not used These parameters do not reset automatically
PCmd_Unlock		Mode.PCmd_Unlock		
PCmd_Reset	BOOL		0	<ul style="list-style-type: none"> Set PCmd_Reset to 1 to reset all alarms requiring reset This parameter is always reset automatically
PCmd_IntlkTripAck	BOOL	IntlkTrip.PCmd_Ack	0	<ul style="list-style-type: none"> Set PCmd_<Alarm>Ack to 1 to Acknowledge alarm The parameter is reset automatically
PCmd_ActuatorFaultAck		ActuatorFault.PCmd_Ack		
PCmd_IOFaultAck		IOFault.PCmd_Ack		
PCmd_IntlkTripSuppress	BOOL	IntlkTrip.PCmd_Suppress	0	When Cfg_PCmdClear is 1: <ul style="list-style-type: none"> Set PCmd_<Alarm>Suppress to 1 to suppress alarm Set PCmd_<Alarm>Unsuppress to 1 to unsuppress alarm These parameters reset automatically When Cfg_PCmdClear is 0: <ul style="list-style-type: none"> Set PCmd_<Alarm>Suppress to 1 to suppress alarm Set PCmd_<Alarm>Suppress to 0 to unsuppress alarm PCmd_<Alarm>Unsuppress is not used These Parameters do not reset automaticallyS
PCmd_ActuatorFaultSuppress		ActuatorFault.PCmd_Suppress		
PCmd_IOFaultSuppress		IOFault.PCmd_Suppress		
PCmd_IntlkTripUnsuppress		IntlkTrip.PCmd_Unsuppress		
PCmd_ActuatorFaultUnsuppress		ActuatorFault.PCmd_Unsuppress		
PCmd_IOFaultUnsuppress		IOFault.PCmd_Unsuppress		
PCmd_IntlkTripUnshelve	BOOL	IntlkTrip.PCmd_Unshelve	0	<ul style="list-style-type: none"> Set PCmd_<Alarm>Unshelve to 1 to Unshelve alarm The parameter is reset automatically
PCmd_ActuatorFaultUnshelve		ActuatorFault.PCmd_Unshelve		
PCmd_IOFaultUnshelve		IOFault.PCmd_Unshelve		
OCmd_BumpOpen	BOOL		0	Operator command to bump valve open (available if feedback bad).

Table 7 - P_ValveC Input Parameters

Input Parameter	Data Type	Alias For	Default	Description
OCmd_BumpClose	BOOL		0	Operator command to bump valve closed (available if feedback bad).
OCmd_Bypass	BOOL		0	Operator command to bypass all bypassable interlocks.
OCmd_Check	BOOL		0	Operator command to check (not bypass) all interlocks.
MCmd_Disable	BOOL		0	Maintenance command to disable control valve.
MCmd_Enable	BOOL		0	Maintenance command to enable control valve.
MCmd_Acq	BOOL	Mode.MCmd_Acq	0	Maintenance command to acquire ownership (Operator/Program/Override to Maintenance)
MCmd_Rel	BOOL	Mode.MCmd_Rel	0	Maintenance command to release ownership (Maintenance to Operator/Program/Override)
OCmd_AcqLock	BOOL	Mode.OCmd_AcqLock	0	Operator command to acquire (Program to Operator)/lock ownership.
OCmd_Unlock	BOOL	Mode.OCmd_UnlockRel	0	Operator command to unlock/release (Operator to Program) ownership.
OCmd_Reset	BOOL		0	Operator command to reset all alarms requiring reset.
OCmd_ResetAckAll	BOOL		0	Operator command to acknowledge and reset all alarms and latched shed conditions.

Analog/Pulsed Control Valve Output Structure

Output parameters include the following:

- Output data elements (Out_) are the primary outputs of the instruction, typically used by hardware output modules; however, they can be used by other application logic.
- Value data elements (Val_) are numeric outputs of the instruction for use by the HMI. Values also can be used by other application logic or software packages.
- Source and Quality data elements (SrcQ_) are outputs of the instruction used by the HMI to indicate PV source and quality.
- Status data elements (Sts_) are bit outputs of the instruction for use by the HMI. Status bits also can be used by other application logic.
- Error data elements (Err_) are outputs of the instruction that indicate a particular configuration error. If any Err_ bit is set then the Sts_Err configuration error summary status is set and the Invalid Configuration indicator is displayed on the HMI.
- Not Ready data elements (Nrdy_) are bit outputs of the instruction for use by the HMI for displaying the Device Not Ready indicator. Not Ready bits can also be used by other application logic.
- Alarm data elements (Alm_) are outputs of the instruction that indicate a particular alarm has occurred.
- Acknowledge data elements (Ack_) are outputs of the instruction that indicate the corresponding alarm has been acknowledged.

- Ready data elements (Rdy_) are bit outputs of the instruction used by the HMI to enable and disable Command buttons and Setting entry fields.

Table 8 - P_ValveC Output Parameters

Output Parameter	Data Type	Alias For	Description
EnableOut	BOOL		Enable Output: The EnableOut signal is not manipulated by this instruction. Its output state always reflects EnableIn input state.
Out_CV	REAL		CV output in raw (I/O Card) units.
Out_Open	BOOL		Pulse output to drive valve open.
Out_Close	BOOL		Pulse output to drive valve closed.
Val_Pos	REAL		Valve actual position from feedback (CV engineering units).
Val_CVSet	REAL		Value of selected CV Setting (before rate limiting, CV engineering units).
Val_CVOut	REAL		Value of CV output (after clamping and ramping) (CV engineering units).
Val_CVRoCLimInc	REAL		Value of CV Rate of Change Limit, increasing (in engineering units/second).
Val_CVRoCLimDec	REAL		Value of CV Rate of Change Limit, decreasing (in engineering units/second).
Val_CVEUMin	REAL		Minimum of scaled range = Min (Cfg_CVEUMin, Cfg_CVEUMax).
Val_CVEUMax	REAL		Maximum of scaled range = Max (Cfg_CVEUMin, Cfg_CVEUMax.)
SrcQ_IO	SINT		I/O signal source and quality.
SrcQ			Final position source and quality. GOOD 0 = I/O live and confirmed good quality 1 = I/O live and assumed good quality 2 = No feedback configured, assumed good quality TEST 8 = Device simulated 9 = Device loopback simulation 10 = Manually entered value UNCERTAIN 16 = Live input, off-specification 17 = Value substituted at device/bus 18 = Value substituted by maintenance (Has and not Use) 19 = Shed, using last good value 20 = Shed, using replacement value BAD 32 = Signal failure (out-of-range, NaN, invalid combination) 33 = I/O channel fault 34 = I/O module fault 35 = Bad I/O configuration (for example, scaling parameters)
Val_Fdbk	SINT		Device feedback includes the following: 0 = Moving 1 = Closed 2 = Opened 3 = Limit Switch Failure
Val_Sts	SINT		Device status includes the following: 0 = At Target 1 = Ramping to close 2 = Ramping to open 3 = Clamped at minimum 4 = Clamped at maximum 5 = Closing to target (bump) 6 = Opening to target (bump) 33 = Disabled
Val_Fault	SINT		Device fault status includes the following: 0 = None 32 = I/O Fault 34 = Configuration Error

Table 8 - P_ValveC Output Parameters

Output Parameter	Data Type	Alias For	Description
Val_Mode	SINT	Mode.Val	The current mode is shown with status bits and also as an enumeration 'Val_Mode' as follows: 0 = No mode 1 = Hand 2 = Maintenance 3 = Override 4 = Program (locked) 5 = Operator (locked) 6 = Program (unlocked, Operator is default) 7 = Operator (unlocked, Program is default) 8 = Program (unlocked, Program is default) 9 = Operator (unlocked, Operator is default)
Val_Owner	DINT		Current object owner ID (0 = not owned).
Val_Notify	SINT		Current alarm level and acknowledgement (enumeration): 0 = No alarm 1 = Alarm cleared: a reset or acknowledge is required 2 = Low (acknowledged) 3 = Low (unacknowledged) 4 = Medium (acknowledged) 5 = Medium (unacknowledged) 6 = High (acknowledged) 7 = High (unacknowledged) 8 = Urgent (acknowledged) 9 = Urgent (unacknowledged)
Sts_CVInfNaN	BOOL		1 = Selected CV is Infinite or Not A Number (1.\$, 1.#NaN).
Sts_PosInfNaN	BOOL		1 = Inp_PosFdbk is Infinite or Not A Number.
Sts_BumpOpen	BOOL		1 = Bump open requested or active.
Sts_BumpClose	BOOL		1 = Bump close requested or active.
Sts_Ramping	BOOL		1 = CV is ramping to target.
Sts_Clamped	BOOL		1 = CV Set is clamped at CVMinimum or CVMaximum.
Sts_SkipRoCLim	BOOL		1 = Rate of Change limiting was skipped this scan (Maintenance, Override, Interlock, Hand).
Sts_Active	BOOL		1 = CV is greater than Cfg_MaxClosedPos, show graphic symbol as 'active'.
Sts_Available	BOOL		1 = Control valve available for control by automation (Program).
Sts_Bypass	BOOL		1 = Bypassable interlocks are bypassed.
Sts_BypActive	BOOL		1 = Bypassing active (Bypassed or Maintenance).
Sts_Disabled	BOOL		1 = Output is disabled.
Sts_LSFail	BOOL		1 = Limit switch overlap failure.
Sts_NotRdy	BOOL		1 = Device is not ready to be operated.
Nrdy_Disabled	BOOL		1 = Device Not Ready: <ul style="list-style-type: none"> • Device disabled by Maintenance • Configuration error • Interlock not OK • I/O Fault (shed requires reset) • Device Logic disabled/No mode.
Nrdy_CfgErr			
Nrdy_Intlk			
Nrdy_IOFault			
Nrdy_NoMode			
Sts_MaintByp	BOOL		1 = Device has a maintenance bypass function active.
Sts_Almlnh	BOOL		1 = One or more alarms shelved, disabled or suppressed.
Sts_Err	BOOL		1 = Error in configuration: see detail bits for reason.

Table 8 - P_ValveC Output Parameters

Output Parameter	Data Type	Alias For	Description
Err_Limit	BOOL		1 = Error in configuration: CV limits swapped.
Err_EU	BOOL		1 = Error in configuration: Scaled CV engineering units minimum = maximum.
Err_Raw	BOOL		1 = Error in configuration: Raw output scaling minimum = maximum.
Err_Fdbk	BOOL		1 = Error in configuration: Raw feedback scaling minimum = maximum.
Err_Timer	BOOL		1 = Error in configuration: Invalid timer preset (use 0...2,147,483).
Err_Alarm	BOOL		1 = Error in configuration: Alarm minimum on time or severity.
Sts_Hand	BOOL	Mode.Sts_Hand	1 = Mode is Hand (supersedes Maintenance, Override, Program, Operator).
Sts_Maint	BOOL	Mode.Sts_Maint	1 = Mode is Maintenance (supersedes Override, Program, Operator).
Sts_Ovrd	BOOL	Mode.Sts_Ovrd	1 = Mode is Override (supersedes Program, Operator).
Sts_Prog	BOOL	Mode.Sts_Prog	1 = Mode is Program (auto).
Sts_Oper	BOOL	Mode.Sts_Oper	1 = Mode is Operator (manual).
Sts_ProgOperLock	BOOL	Mode.Sts_ProgOperLock	1 = Program or operator has requested Mode Lock.
Sts_NoMode	BOOL	Mode.Sts_NoMode	1 = No mode (disabled because EnableIn is false).
Sts_MAcqRcvd	BOOL	Mode.Sts_MAcqRcvd	1 = Maintenance Acquire command received this scan.
Sts_IntlkTrip	BOOL	IntlkTrip.Inp	1 = Status: CV held or forced by interlock not OK.
Sts_ActuatorFault		ActuatorFault.Inp	1 = Actuator fault detected (input).
Sts_IOFault		IOFault.Inp	0 = I/O communication OK. 1 = I/O communication failure.
Alm_IntlkTrip	BOOL	IntlkTrip.Alm	1 = Alarm: CV held or forced by interlock not OK.
Alm_ActuatorFault		ActuatorFault.Alm	1 = Alarm: Actuator fault detected.
Alm_IOFault		IOFault.Alm	1 = I/O Fault alarm.
Ack_IntlkTrip	BOOL	IntlkTrip.Ack	1 = Interlock trip alarm, actuator fault alarm, or I/O fault alarm is acknowledged.
Ack_ActuatorFault		ActuatorFault.Ack	
Ack_IOFault		IOFault.Ack	
Sts_IntlkTripDisabled	BOOL	IntlkTrip.Disabled	1 = Interlock trip alarm, actuator fault alarm, or I/O fault alarm is disabled by maintenance.
Sts_ActuatorFaultDisabled		ActuatorFault.Disabled	
Sts_IOFaultDisabled		IOFault.Disabled	
Sts_IntlkTripShelved	BOOL	IntlkTrip.Shelved	1 = Interlock trip alarm, actuator fault alarm, or I/O fault alarm is shelved by operator.
Sts_ActuatorFaultShelved		ActuatorFault.Shelved	
Sts_IOFaultShelved		IOFault.Shelved	
Sts_IntlkTripSuppressed	BOOL	IntlkTrip.Suppressed	1 = Interlock trip alarm, actuator fault alarm, or I/O fault alarm is suppressed by program.
Sts_ActuatorFaultSuppressed		ActuatorFault.Suppressed	
Sts_IOFaultSuppressed		IOFault.Suppressed	
Rdy_BumpOpen	BOOL		1 = Ready to receive OCmd_BumpOpen, OCmd_BumpClose, OCmd_Bypass, OCmd_Check, or OCmd_Reset (enables HMI button).
Rdy_BumpClose			
Rdy_Bypass			
Rdy_Check			
Rdy_Reset			

Table 8 - P_ValveC Output Parameters

Output Parameter	Data Type	Alias For	Description
Rdy_Disable	BOOL		1 = Ready to receive MCmd_Disable or MCmd_Enable (enables HMI button).
Rdy_Enable			
Rdy_ResetAckAll	BOOL		1 = At least one alarm or latched shed condition requires reset or acknowledgment.
Rdy_CV	BOOL		1 = Ready to receive OSet_CV, OSet_CVRoCLimInc, or OSet_CVRoCLimDec (enables data entry field).
Rdy_CVRoCLimInc			
Rdy_CVRoCLimDec			
P_ValveC	BOOL		Unique parameter name for auto-discovery.

Analog/Pulsed Control Valve Local Configuration Tags

Configuration parameters that are array, string, or structure data types cannot be configured as parameters for Add-On Instructions. Configuration parameters of these types appear as local tags to the Add-On Instruction. Local tags can be configured through the HMI faceplates or in Studio 5000 Logix Designer® application by opening the Instruction Logic of the Add-On Instruction instance and then opening the Data Monitor on a local tag. These parameters cannot be modified by using controller logic or Logix Designer application export/import functionality.

Table 9 - P_ValveC Local Configuration Tags

Tag Name	Data Type	Default	Description
Cfg_CVNavTag	STRING_NavTag	''	Tagname for destination of CV Navigation button. IMPORTANT: This tag does not work in FactoryTalk ME Software.
Cfg_Desc	STRING_40	'Control Valve'	Description for display on HMI. This string is shown in the title bar of the faceplate.
Cfg_EU	STRING_8	'% Open'	Engineering units for display on HMI.
Cfg_Label	STRING_20	'Control Valve'	Label for graphic symbol displayed on HMI. This string appears on the graphic symbol.
Cfg_Tag	STRING_20	'P_ValveC'	Description for display on HMI. This string is shown in the title bar of the faceplate.

Operations

This section describes the primary operations for Add-On Instructions.

Modes

This instruction uses the following standard modes, which are implemented by using an embedded P_Mode Add-On Instruction.

Table 10 - Modes

Mode	Description
Operator	The Operator owns control of the group. Operator commands (OCmd_) and Operator settings (OSet_) from the HMI are accepted.
Program	Program logic owns control of the group. Program commands (PCmd_) and Program settings (PSet_) are accepted.
Override	Priority logic owns control of the group and supersedes Operator and Program control. Override Inputs (Inp_OvrCmd and other Inp_OvrDxxx values) are accepted. If so configured, bypassable interlocks and permissives are bypassed.
Maintenance	Maintenance owns control of the group and supersedes Operator, Program, and Override control. Operator commands and settings from the HMI are accepted. Bypassable interlocks and permissives are bypassed, and device timeout checks are not processed.
Hand	Hardwired logic or other logic outside the instruction owns control of the group. The instruction tracks the state of the device for bumpless transfer back to one of the other modes.
No Mode	The device is disabled and has no owner because the EnableIn input is false. The main instruction Logic routine is not being scanned. See Execution section for more information on EnableInFalse processing.

See Rockwell Automation Library of Process Objects: Common Mode Block (P_Mode) Reference Manual, publication [SYSLIB-RM005](#), for more information.

Alarms

This instruction uses the following alarms, which are implemented by using embedded P_Alarm and P_Gate Add-On Instructions.

Alarm Name	P_Alarm Name	P_Gate Name	Description
Can't Start	CantStart	None	Raised when there are not enough motors available to start to satisfy the entered Demand. Too many motors are faulted or stopped in a mode other than Program.
Can't Stop	CantStop	None	Raised when there are not enough motors available to stop to satisfy the entered Demand. Too many motors are running in a mode other than Program.
Interlock Trip	IntkTrip	None	Raised when the motor is running and an interlock 'not OK' condition causes the motor to stop. If interlocks are not bypassed, a bypassable interlock or a non-bypassable interlock 'not OK' condition initiates an interlock trip. If interlocks are bypassed, only a non-bypassable interlock 'not OK' condition initiates an interlock trip.

Parameters of the P_Alarm object can be accessed by using the following convention: [P_Alarm Name].[P_Alarm Parameter].

Simulation

Simulation in P_ValveC holds the analog output at zero and holds the discrete pulse outputs off while simulating a working valve. The I/O fault input is ignored.

You must set the Inp_Sim parameter in the controller to '1' to enable simulation.

The Loopback Test icon  is displayed at the bottom left of the Operator faceplate indicating the device is in simulation.

When you have finished in simulation, set the Inp_Sim parameter in the controller to '0' to return to normal operation.

Execution

The following table explains the handling of instruction execution conditions.

Condition	Description
EnableIn False (false rung)	Processing for EnableIn False (false rung) is handled the same as if the Control Valve were Disabled by Command. The discrete open and close outputs are de-energized. The analog CV output is de-energized (zeroed). The Control Valve instruction is shown as Disabled on the HMI. The mode is shown as NO MODE.
Powerup (prescan, first scan)	Processing of modes and alarms on pre-Scan and Powerup is handled by the embedded P_Mode and P_Alarm instructions - refer to their specifications for details. On Power-up, the Control Valve ownership is cleared and any commands received while the controller was in PROG mode are discarded; otherwise, all data remains in the state it was in at power down.
Postscan	No SFC Postscan logic is provided.

See the Logix5000 Controllers Add-On Instructions Programming Manual, publication [1756-PM010](#), for more information.

Programming Examples

This section shows two examples for using the P_ValveC instruction.

Example 1: Manual Loading Station

This example uses the P_ValveC instruction to implement a manual loading station for a pressure control valve that is used to regulate gas supply to a process. The control valve in our example has open and closed limit switches and a position feedback. The desired valve position is provided by the operator through the HMI faceplate.

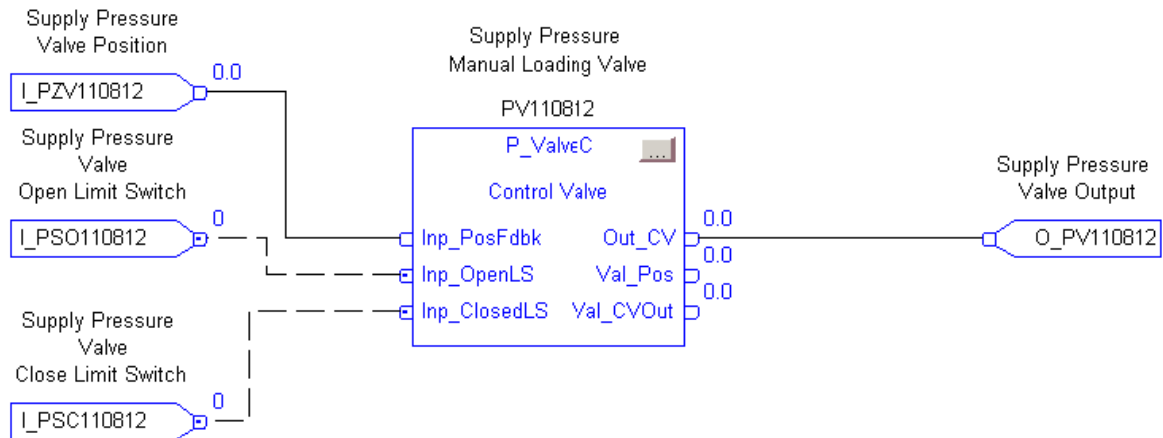

The field inputs for position feedback, open limit switch, and closed limit switch (as shown in the illustration) are connected to the instruction inputs `Inp_PosFdbk`, `Inp_OpenLS`, and `Inp_ClosedLS`. The `Out_CV` is connected to the field output going to the valve.

The parameters `Cfg_HasOpenLS` and `Cfg_HasClosedLS` are both set to 1 so the instruction knows the field is providing open and closed limit switches. The parameters `Cfg_UseOpenLS` and `Cfg_UseClosedLS` are set to 1 so that these limit switches are used to determine device status.

The analog output card is expecting an output in units of 4...20 mA; however, the faceplate shows the value in terms of 0...100% open. Therefore, the scaling parameters are set as follows:

```

Cfg_CVEUMin:  0
Cfg_CVEUMax:  100
Cfg_CVRawMin:  4
Cfg_CVRawMax:  20

```

The feedback signal is also provided in units of 4...20 mA, so the parameters `Cfg_FdbkRawMin` and `Cfg_FdbkRawMax` are set to 4 and 20, respectively.

We want to limit the operator entry of the desired valve position to 80% open by setting `Cfg_MaxCV` to 80.

The parameters `Cfg_HasIOFaultAlm`, `Cfg_HasActuatorFaultAlm`, and `Cfg_HasIntlkTripAlm` are all set to 0 to indicate that no alarms are necessary for this device.

Lastly, configure the following local configuration tags to drive the text on the HMI faceplate. In this example, they are set as follows:

<code>Cfg_Tag:</code>	PV110812
<code>Cfg_Label:</code>	Gas Supply Valve
<code>Cfg_Desc:</code>	Gas Supply Valve Manual Loading Station
<code>Cfg_EU:</code>	%

Example 2: Ratcheting Control Valve

This example uses the `P_ValveC` instruction to automate a ratcheting valve that is driven open or closed by using two discrete outputs to control flow. The flow valve in our example has a position feedback. The desired valve position is provided by an output of a control algorithm that is elsewhere in logic.

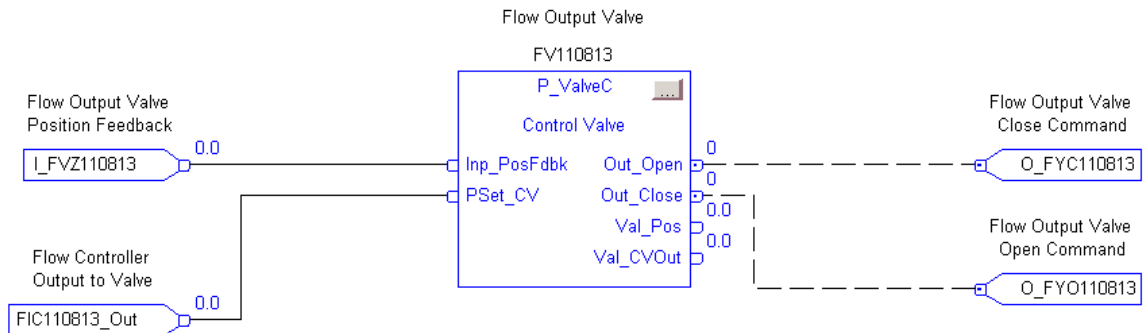

In this example, the field inputs for position feedback are wired (or connected) to the instruction input `Inp_PosFdbk`. `Out_Open` and `Out_Close` are connected to the field outputs going to the valve. The input to the instruction to set valve position is wired to `PSet_CV`. `Cfg_ProgDefault` is set to 1 so the instruction defaults to Program mode.

The analog output is not used; however, the faceplate shows the value in terms of 0...100% open. Therefore, the scaling parameters are set as follows:

<code>Cfg_CVEUMin:</code>	0
<code>Cfg_CVEUMAx:</code>	100
<code>Cfg_CVRawMin:</code>	0 - default
<code>Cfg_CVRawMax:</code>	100 - default

The feedback signal is provided in units of 4...20 mA, so the parameters `Cfg_FdbkRawMin` and `Cfg_FdbkRawMax` are set to 4 and 20, respectively.

In this example, the ratcheting control valve is to be adjusted by cycling the open or close valve command for a period of time proportional to the amount the valve is to be moved. `Cfg_CycleT` is set to 10, to define the overall period of the cycle to cycle on and off the open or close output. `Cfg_OpenRate` and `Cfg_OpenCloseRate` are both set to 1, which means the required valve output is energized 1 second for every 1% difference between the desired position and the feedback position.

`Cfg_MaxOnT` is set to 5 so that the output is energized for no more than 5 seconds of the 10-second cycle time to allow for the valve to move, and the feedback to be verified before the next cycle. `Cfg_MinOnT` is set to 1 so that the output does not pulse if the calculated pulse time is less than 1 second.

The parameters `Cfg_HasIOFaultAlm`, `Cfg_HasActuatorFaultAlm`, and `Cfg_HasIntlkTripAlm` are all set to 0 to indicate that no alarms are necessary for this device.



Lastly, configure the following local configuration tags to drive the text on the HMI faceplate. In this example, they are set as follows:

<code>Cfg_Tag:</code>	FV110813
<code>Cfg_Label:</code>	Flow Control Valve
<code>Cfg_Desc:</code>	Flow Ratcheting Control Valve
<code>Cfg_EU:</code>	%

Display Elements

A display element (global object) is created once and can be referenced multiple times on multiple displays in an application. When changes are made to the original (base) object, the instantiated copies (reference objects) are automatically updated. Use of global objects, in conjunction with tag structures in the ControlLogix system, aid consistency and save engineering time.

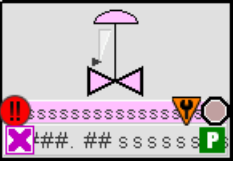
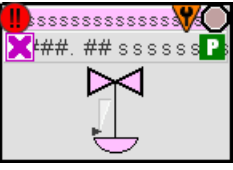
Table 11 - P_ValveC Display Elements Description

Display Element Name	Display Element	Description
GO_ProcessControlValve		Normal controlled valve symbol for horizontal pipe.
GO_ProcessControlValve1		Inverted controlled valve symbol for horizontal pipe.
GO_ProcessControlValve2		Controlled valve symbol for vertical pipe (pipe to the left).
GO_ProcessControlValve3		Controlled valve symbol for vertical pipe (pipe to the right).





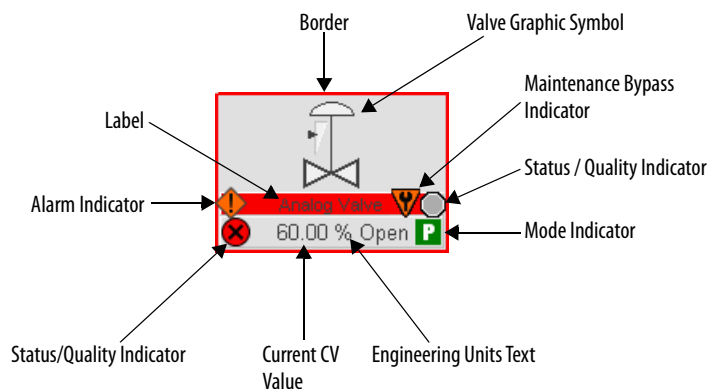



Common attributes of the P_ValveC global objects include the following:

- Animated graphic symbol representing the device
- Current value of the CV with engineering unit text
- Status/Quality indicators
- Mode indicator
- Maintenance Bypass indicator
- Label
- Color changing alarm border that blinks on unacknowledged alarm
- Alarm indicator that changes color and symbol with the severity of an alarm



Status/Quality Indicators

One of these symbols appears on the graphic symbol when the described condition is true.

Graphic Symbol	Description
	Invalid configuration.
	Data quality bad/failure.
	Data Quality degraded: uncertain, test, simulation, substitution, or out of specification.
	The group has been disabled.
	Device not ready to operate.
	Motor running.
	Motor idle.
	Motor not controllable.
No symbol displayed	I/O communication and quality good, configuration valid.

TIP

When the Invalid Configuration Indicator appears, you can find what configuration setting is invalid by following the indicators. Click the graphic symbol to open the faceplate. The Invalid Configuration indicator appears next to the appropriate tab at the top of the faceplate to guide you in finding the configuration error. Once you navigate to the tab, the misconfigured item is flagged with this indicator or appear in a magenta box.

For the Analog/Pulsed Control Valve Instruction, the Invalid Configuration indicator appears under the following conditions:

- CV Scaled EU Minimum and EU Maximum scaling parameters are set to the same value.
- CV Output Raw Minimum and Raw Maximum scaling parameters are set to the same value.
- Position Feedback Raw Minimum and Raw Maximum scaling parameters are set to the same value.
- Maximum CV clamp value is less than the Minimum CV clamp value.
- Pulse output Cycle Time is set to a value less than zero or greater than 2,147,483 seconds.
- Alarm Minimum On Time is set to a value less than zero or greater than 2,147,483 seconds.
- Alarm Severity is set to a value less than 1 or greater than 1000.

TIP When the Not Ready indicator appears, you can find what condition is preventing operation by following the indicators. Click the graphic symbol to open the faceplate. The Not Ready indicator appears next to the appropriate tab at the top of the faceplate to guide you in finding the condition. When you navigate to the tab, the condition preventing operation is flagged.









For the Analog/Pulsed Control Valve Instruction, the Device Not Ready indicator appears under the following conditions:

- Device has been disabled by Maintenance.
- There is a configuration error.
- Interlock is not OK.
- There has been an I/O Fault and shed requires reset.

Device Logic has been disabled or there is no mode.

Mode Indicators

One of these symbols appears on the right side of the graphic symbol to indicate the mode of the object instruction.







Graphic Symbol	Description
Transparent	Operator mode (if the default mode is Operator and the current mode is Operator, the mode indicator is transparent).
	Operator mode (if the default mode is Program).
	Operator mode locked.
Transparent	Program mode (if the default mode is Program and the current mode is Program, the mode indicator is transparent).
	Program mode (if the default mode is Operator).
	Program mode locked.
	Override mode
	Maintenance mode.
	Hand mode
	No mode.

TIP The images provided for the Operator and Program default modes are transparent; therefore, no mode indicators are visible if the device is in its default mode. This behavior can be changed by replacing the image files for these mode indicators with images that are not transparent.

See Rockwell Automation Library of Process Objects: Common Mode Block (P_Mode) Reference Manual, publication [SYSLIB-RM005](#), for more information.

Alarm Indicators

One of these symbols appears on the left side of the label to indicate the described alarm condition and the alarm border and label background change color. The alarm border and label background blink if acknowledgement of an alarm condition is required. Once the alarm is acknowledged, the alarm border and label background remain the color that corresponds to the severity of the alarm.

Symbol	Border and Label Background	Description
	No change in color	Alarm Inhibit: an alarm is suppressed by the Program, disabled by Maintenance, or shelved by the Operator.
	White	Return to normal (no alarm condition), but a previous alarm has not been acknowledged.
	Blue	Low severity alarm.
	Yellow	Medium severity alarm.
	Red	High severity alarm.
	Magenta	Urgent severity alarm.
No symbol	No change in color	No alarm or alarm inhibit condition, and all alarms are acknowledged.

See Rockwell Automation Library of Process Objects: Common Alarm Block (P_Alarm) Reference Manual, publication [SYSLIB-RM002](#), for more information.

Maintenance Bypass Indicator

This symbol appears to the right of the label to indicate that a maintenance bypass has been activated.

TIP When the Maintenance Bypass Indicator appears, you can find what condition was bypassed by following the indicators. Click the graphic symbol to open the faceplate. The Maintenance Bypass Indicator appears next to the appropriate tab at the top of the faceplate to guide you in finding the bypass. Once you navigate to the tab, the bypassed item is flagged with this indicator.

For the Analog/Pulsed Control Valve Instruction, the Maintenance bypass indicator appears when the bypassable interlocks and permissives have been bypassed.

Using Display Elements

The global objects for P_ValveC can be found in the global object file (RA-BAS) Process Graphics Library.ggfx.

Complete the following steps to use a global object.

1. Copy it from the global object file and paste it in the display file.

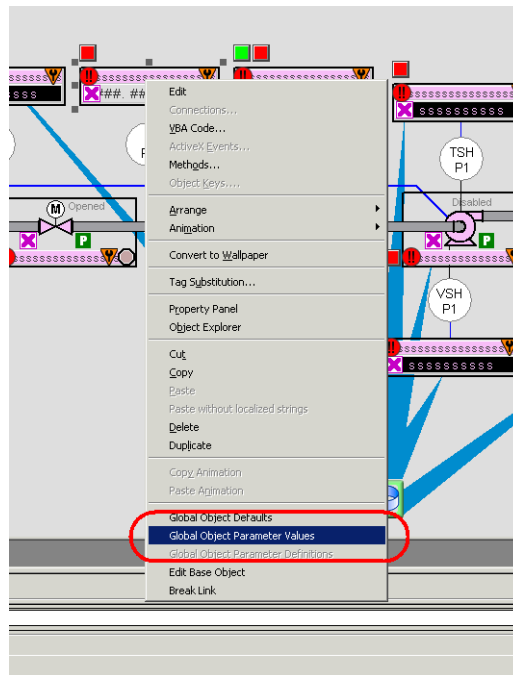

2. In the display file, right-click the global object file and choose Global Object Parameter Values.

The Global Object Parameter Values dialog box appears.

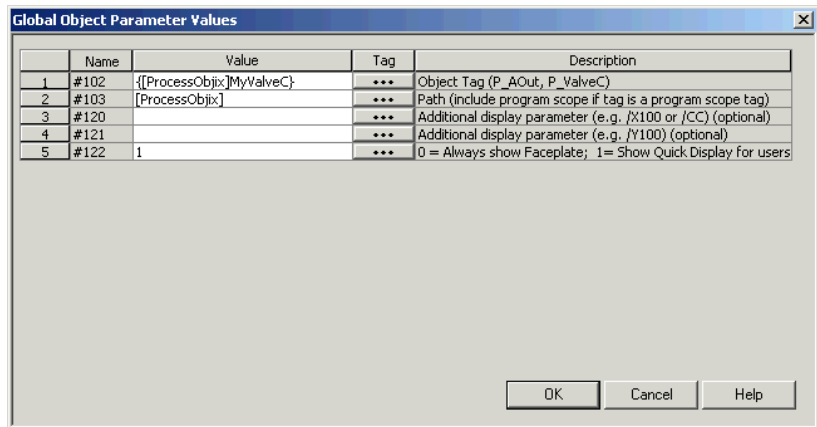

3. Type the tag or value in the Value column as specified in the Description column.

TIP You can click the ellipsis (...) to browse and select a tag.
 Values for items marked '(optional)' can be left blank.

4. Click OK.

The global object parameters are as follows.

Parameter	Required	Description
#102	Y	Object tag to point to the name of the associated object Add-On Instruction in the controller.
#103	Y	Path used for display navigation features to other objects. Include program scope if tag is a program scope tag.
#120	N	Additional parameter to pass to the display command to open the faceplate. Typically used to define position for the faceplate.
#121	N	Additional parameter to pass to the display command to open the faceplate. if defining X and Y coordinate, separate parameters so that X is defined by #120 and Y is defined by #121. This lets the same parameters be used in subsequent display commands originating from the faceplate.
#122	Y	These are the options for the global object display: 0 = Always show faceplate 1 = Show Quick Display for users without Maintenance access (Code C) 2 = Always show Quick Display

Quick Display

The Quick Display screen provides a means for operators to perform simple interactions with the P_ValveC instruction instance. From the Quick Display, you can navigate to the faceplate for full access for operation, maintenance, and configuration.

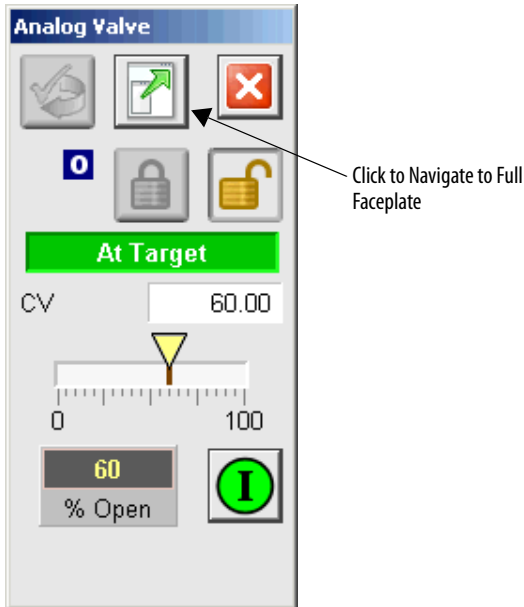

Faceplate

The P_ValveC faceplate consists of five tabs and each tab consists of one or more pages.

Each faceplate contains the value of local configuration tags Cfg_Tag and Cfg_Desc in the title bar.

Tag - Description

The Operator tab is displayed when the faceplate is initially opened. Click the appropriate icon at the top of the faceplate to access a specific tab.

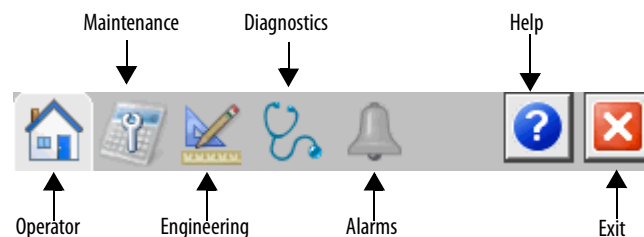

The faceplate provides the means for operators, maintenance personnel, engineers, and others to interact with the P_ValveC Instruction instance, including viewing its status and values and manipulating it through its commands and settings. When a given input is restricted via FactoryTalk View security, the required user security code letter is shown in the tables that follow.

Operator Tab

The Faceplate initially opens to the Operator ('Home') tab. From here, an operator can monitor the device status and manually operate the device when it is in Operator mode.

The Operator tab for an analog output shows the following information:

- Current mode (Operator, Program, Override, Maintenance, or Hand)
- Requested Mode indicator (appears only if the Operator or Program mode has been superseded by another mode)
- Bar graph that displays the current output Controlled Variable (CV) as a yellow pointer and the target CV as a gray line
- Bar graph range is the minimum and maximum engineering units (scaled) values
- Target CV (before rate limiting)
- Increasing and decreasing rates of change for the output CV
- Analog output state (At Target, Ramping Up, or Ramping Down)
- Interlock state
- Input Source and Quality indicator (See 'SrcQ' in the Output parameters table on [page 18](#) for details).

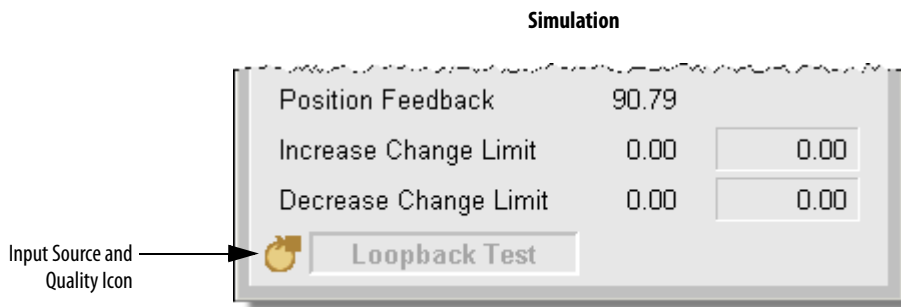
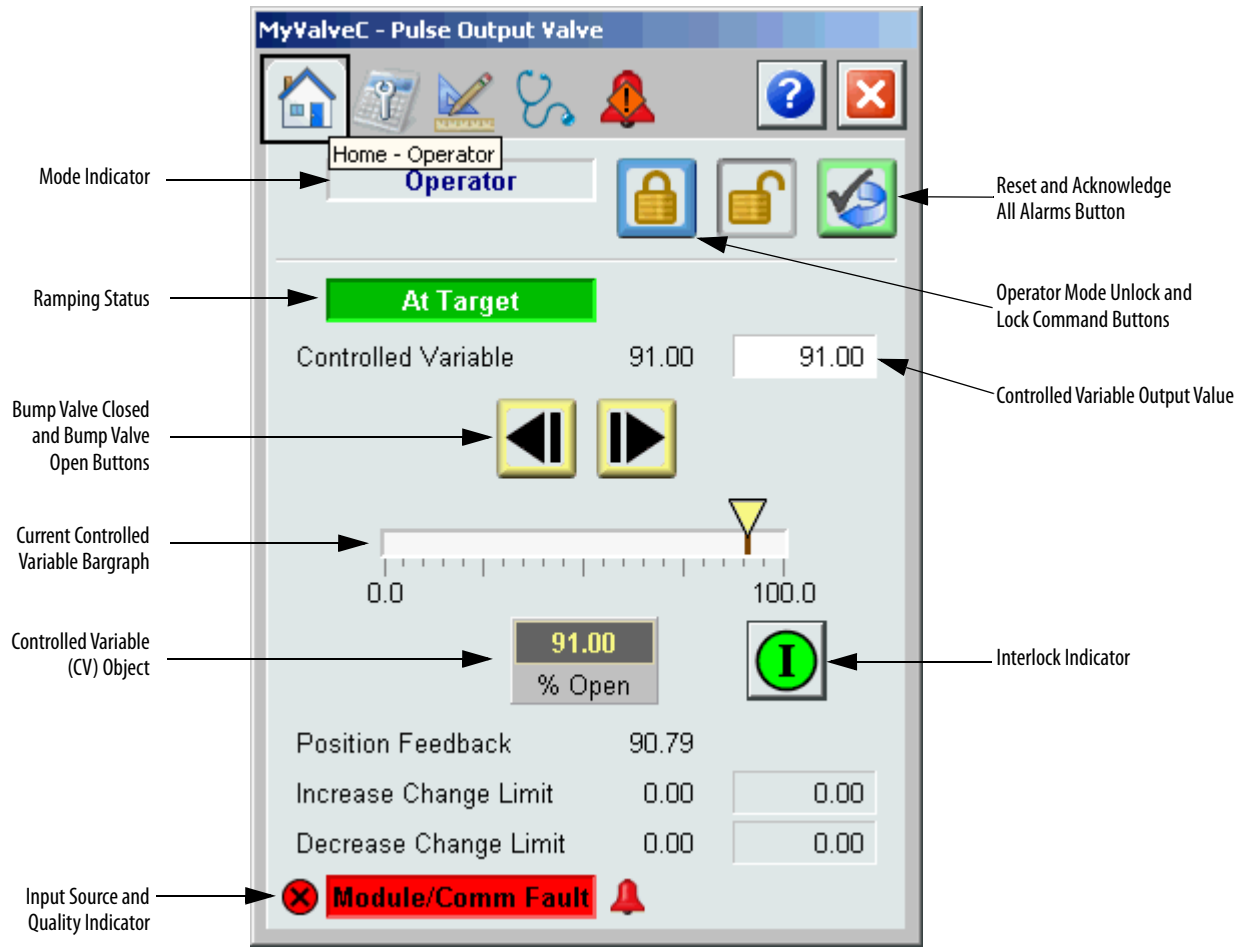

The following table shows the functions included on the Operator tab.

Table 12 - Operator Tab Description









Function	Action	Security
	Click to release Operator mode lock.	Manual Device Operation (Code B)
	Click to lock in Operator mode.	

Table 12 - Operator Tab Description

Function	Action	Security
	Click to request Program mode.	Manual Device Operation (Code B)
	Click to request Operator mode.	
	Click to bump valve open (visible only when position feedback is bad).	
	Click to bump valve closed (visible when only position feedback is bad).	
	Click to reset and acknowledge all alarms.	Acknowledge Alarms (Code F)
	Click to open the Interlock faceplate.	None
Controlled Variable (CV) Output Value	Type a new value for the CV. This entry is available only in Operator or Maintenance mode unless Bumpless Program/Operator Transition is not selected on the configuration screen.	Normal Production (Code A)
Increase Change Limit	Click to enter a new value for the CV maximum Rate of Change when increasing. This entry is available only in Operator or Maintenance mode unless Bumpless Program/Operator Transition is not selected on the configuration screen.	
Decrease Change Limit	Click to enter a new value for the CV maximum Rate of Change when decreasing. This entry is available only in Operator or Maintenance mode unless Bumpless Program/Operator Transition is not selected on the configuration screen.	
Controlled Variable (CV) Object	Click this object to navigate to the faceplate specified by the associated tag name. Allow Navigation on Engineering Tab Page 3 on page 49 must be checked and a tag name typed in to enable this object.	None

If the object is configured to have an interlock object (for example, Cfg_HasIntlkObj is true), the interlock indication becomes a button that opens the faceplate of the source object used as an interlock (often this is a P_Intlk interlock object). If the object is not configured in this way, the interlock is indicator only.

See the Rockwell Automation Library of Process Objects: Interlocks with First Out and Bypass (P_Intlk) Reference Manual, publication [SYSLIB-RM004](#).

One of these symbols appears to indicate the described interlock condition.







Graphic Symbol	Description
	One or more conditions not OK
	Non-bypassed conditions OK
	All conditions OK, bypass active
	All conditions OK

Alarm indicators appear on the Operator tab when the corresponding alarm occurs.

The screenshot shows the 'MyValveC - Pulse Output Valve' control interface. At the top, there are navigation icons (Home, Maintenance, Help, Close) and a 'Maintenance' tab. Below the tab, the valve status is 'Disabled'. The 'Controlled Variable' is 60.00. A scale from 0 to 100 shows the valve position at 60% Open. Below the scale, there are three alarm indicators: a red bell icon on the left (Actuator Fault Alarm), a green circle with a white 'I' and an arrow (Interlock Trip Alarm), and a red bell icon on the right (I/O Fault Alarm). At the bottom, there are 'Position Feedback' (59.88), 'Increase Change Limit' (0.00), and 'Decrease Change Limit' (0.00) fields, along with a 'Comm' button and another red bell icon.

The following table shows the alarm status on the Operator tab.

Table 13 - Operator Tab Alarm Status

Graphic Symbol	Alarm Status
	In alarm (active alarm)
	In alarm and acknowledged
	Out of alarm but not acknowledged
	Alarm suppressed (by Operator; alarm is logged but not displayed)
	Alarm disabled (by Maintenance)
	Alarm Shelved (by Operator)

Maintenance Tab

Maintenance personnel use the information and controls on the Maintenance tab to make adjustments to device parameters, troubleshoot and temporarily work around device problems, and disable the device for routine maintenance.

The Maintenance tab has three pages.

Maintenance Tab Page 1





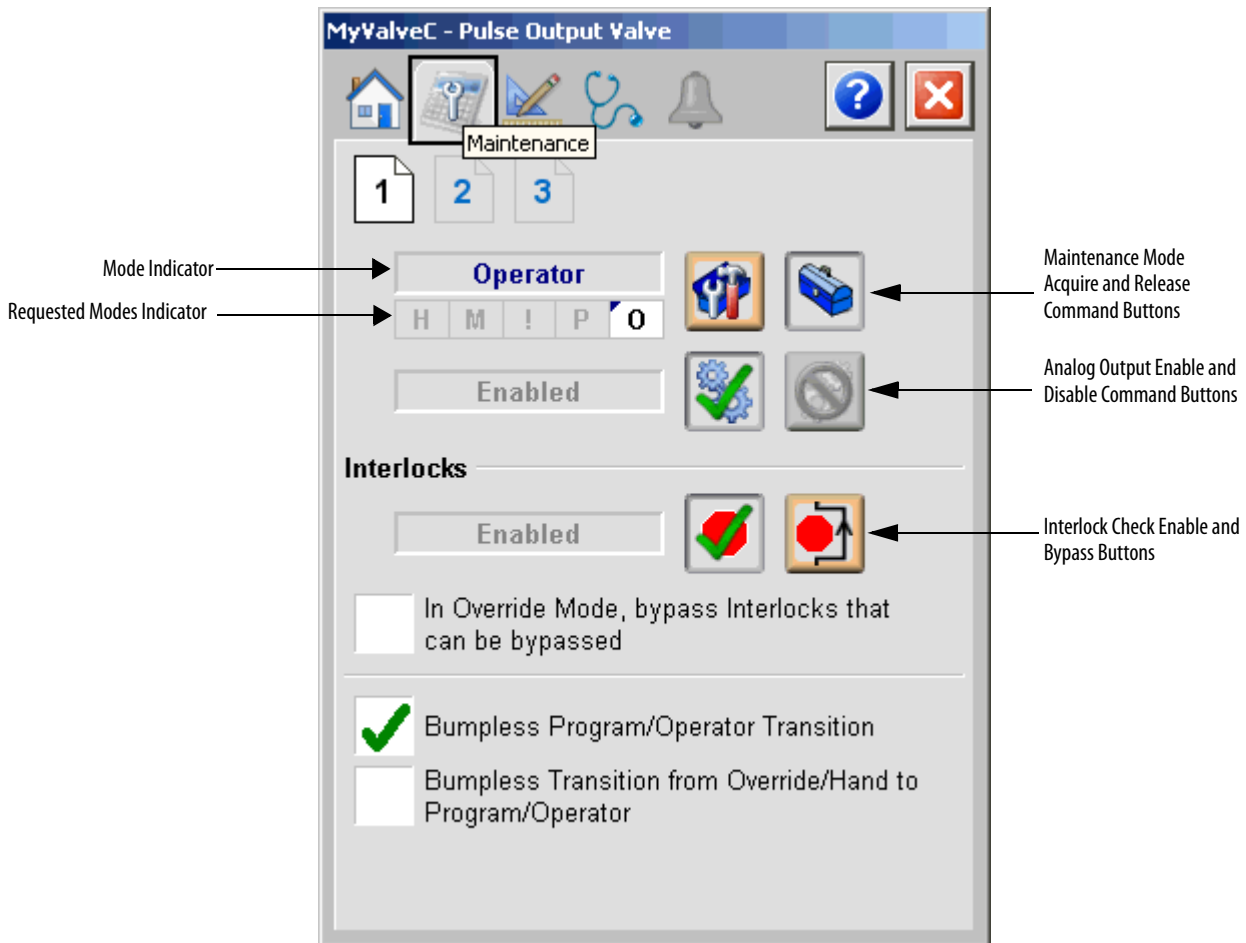

Page 1 of the Maintenance tab shows the following information:

- Current mode (Operator, Program, Override, Maintenance, or Hand)
- Requested Modes indicator - This display highlights all modes that have been requested. The leftmost highlighted mode is the active mode.
- Whether the analog output is enabled or disabled
- Interlock Bypassed/Enabled Indicator



The following table shows the functions on page 1 of the Maintenance tab.

Table 14 - Maintenance Tab Page 1 Description

Function	Action	Security	Configuration Parameters
	Click to release valve from Maintenance mode.	Equipment Maintenance (Code C)	None
	Click to place valve in Maintenance mode.		None
	Click to Enable valve.		None
	Click to Disable valve.		None
	Click to enable checking of all interlocks and permissives.	Disable Alarms (Code H)	None
	Click to bypass checking of bypassable interlocks and permissives.		None
In Override Mode, bypass interlocks that can be bypassed	Check so that bypassable interlocks and permissives are bypassed in Override mode.		Cfg_OvrIntlk
Bumpless Program/Operator Transition	Check so that program settings track operator settings in Operator mode, and operator settings track program settings in Program mode for bumpless transfer.	Equipment Maintenance (Code C)	Cfg_SetTrack
Bumpless Transition from Override/Hand to Program/Operator	Check so that program and operator settings of the CV track the output CV when the mode is Hand or Override.		Cfg_SetTrackOvrHand

See the [Operations](#) section for more information on modes.

Maintenance Tab Page 2

Page 2 of the Maintenance tab shows the following information:

- Source of the data that is used to determine the Output CV along with the configuration and device states that affect the final output value
- Program mode CV Target
- Override mode CV Target
- Hand mode CV Target
- Current Target CV
- Program mode Rate of Change Limits
- Operator mode Rate of Change Limits
- Maximum allowed Rate of Change Limit entry values
- Output CV Current Value that is being used

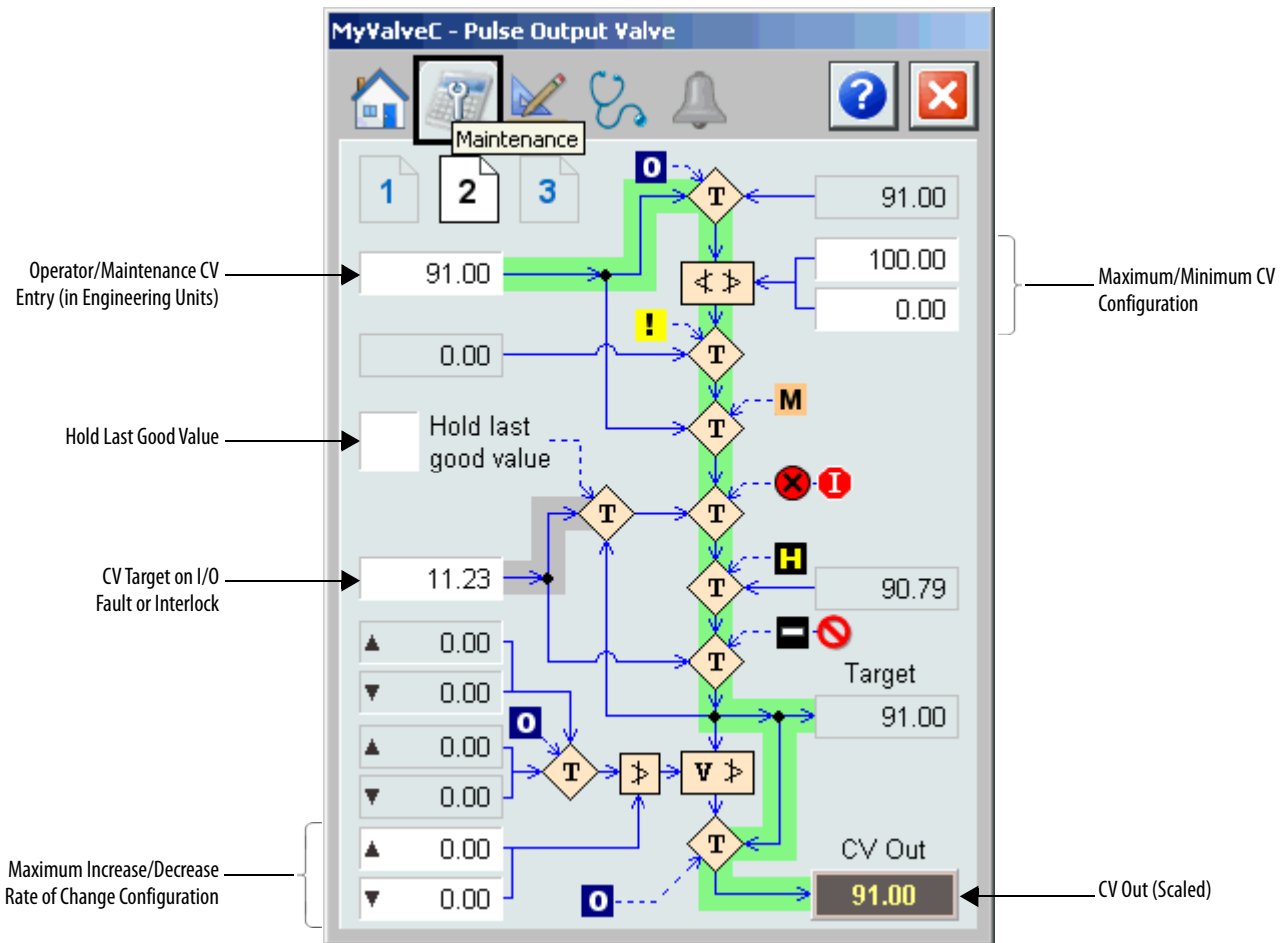

TIP A green path indicates normal operation while a yellow path indicates non-normal operation.

The following table shows a function on page 2 of the Maintenance tab.

Table 15 - Maintenance Tab Page 2 Description

Function	Action	Security	Configuration Parameters
Operator/Maintenance CV Entry (in engineering units)	Type the CV in engineering units. This entry is available in Operator mode and Maintenance mode. It is available in other modes if Bumpless Program/Operator Transition is not selected on Maintenance Tab Page 1.	Normal Operation of Devices (Code A)	None
Maximum/Minimum CV Configuration	Type the clamping limits for the Controlled Variable in engineering units. Clamping limits are enforced in Operator and Program modes only.	Configuration & Tuning Maintenance (Code D)	<ul style="list-style-type: none"> • Cfg_MinCV • Cfg_MaxCV
CV Target When Interlocked or I/O Fault When Hold Not Enabled	Type the interlock target CV in engineering units. This value is used for the CV when interlocked or on an I/O Fault, but only if Hold Last Good Value is not selected.		Cfg_IntlkCV
Increase/Decrease Rate of Change Limits	Type the CV Rate of Change Limit in engineering units per second. This value determines the rate at which the CV output changes upon a change in CV target. A value of zero disables rate of change limiting. The maximum allowed value for this entry is determined by the Maximum Rate of Change Limit (below). This entry is available in Operator mode and Maintenance mode. It is available in other modes if Bumpless Program/Operator Transition is not selected on Maintenance Tab Page 1.	Normal Operation of Devices (Code A)	None
Maximum Rate of Change Limits	Type the maximum allowed value for the Rate of Change Limits in engineering units per second.	Configuration & Tuning Maintenance (Code D)	<ul style="list-style-type: none"> • Cfg_MaxCVRoCInc • Cfg_MaxCVRoCDec
Hold Last Good Value	When checked, the CV holds at the last good value when an Interlock trips or an I/O Fault occurs. When cleared, the CV is set to the configured Interlock CV value when an Interlock trips or an I/O Fault occurs.	Engineering Configuration (Code E)	Cfg_ShedHold

Maintenance Tab Page 3

Page 3 of the Maintenance tab lets you define settings for failure checking and valve position.

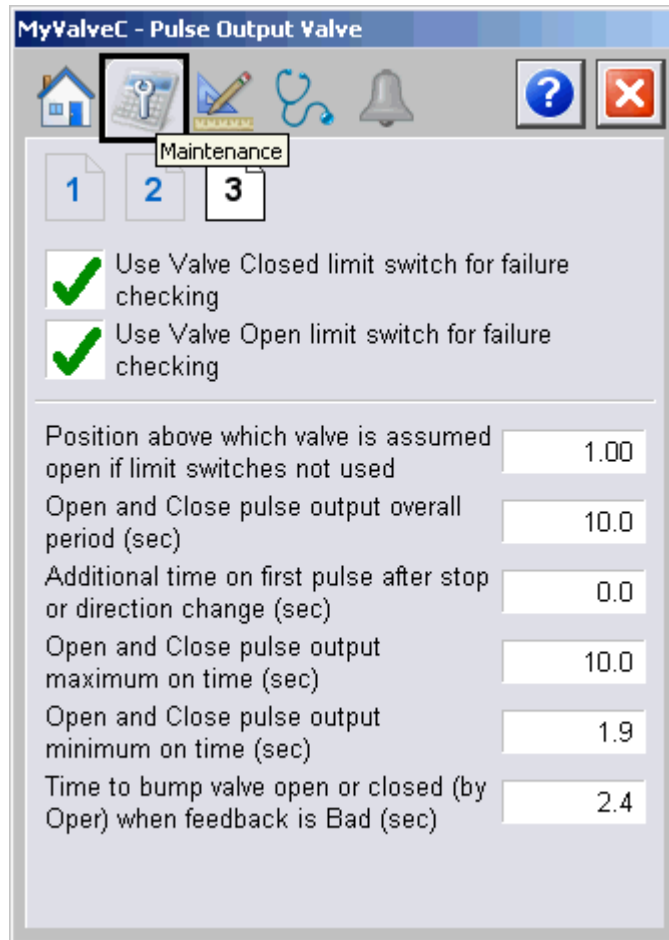

The following table shows a function on page 3 of the Maintenance tab.

Table 16 - Maintenance Tab Page 3 Description

Function	Action	Security	Configuration Parameters
Use Valve Closed limit switch for failure checking	Check to enable the Valve Closed limit switch for failure checking.	Equipment Maintenance (Code C)	Cfg_UseClosedLS
Use Valve Open limit switch for failure checking	Check to enable the Valve Open limit switch for failure checking.		Cfg_UseOpenLS
Position above which valve is assumed open if limit switches not used	Type a value to indicate the position assumed open if limit switches are not used.	Configuration & Tuning Maintenance (Code D)	Cfg_MaxClosedPos
Open and close pulse output overall period (seconds)	Type a value to indicate the time (in seconds) for an open and close pulse.		Cfg_CycleT

Table 16 - Maintenance Tab Page 3 Description

Function	Action	Security	Configuration Parameters
Additional time on first pulse after stop or direction change (seconds)	Type a value to indicate the additional time (in seconds) on the first pulse after a stop or direction change.	Configuration and Tuning Maintenance (Code D)	Cfg_Deadtime
Open and close pulse output maximum on time (seconds)	Type a value to indicate the maximum pulse output time (in seconds) for opening and closing a value.		Cfg_MaxOnT
Open and close pulse output minimum on time (seconds)	Type a value to indicate the minimum pulse output time (in seconds) for opening and closing a value.		Cfg_MinOnT
Time to bump valve open or closed (by Operator) when feedback is Bad (seconds)	Type a value to indicate the amount of time to bump the valve open or closed when feedback is bad.		Cfg_BumpT

Engineering Tab

The Engineering tab provides access to device configuration parameters and ranges, options for device and I/O setup, displayed text, and faceplate-to-faceplate navigation settings, and for initial system commissioning or later system changes.

The Engineering tab has three pages.

Engineering Tab Page 1

Page 1 of the Engineering tab lets you configure the description, label, tag, and CV units for the device.

MyValveC - Pulse Output Valve

Engineering

1 2 3

Mode Configuration Button

Pulse Output Valve

Label: Analog Valve

Tag: MyValveC

Configure Device Description, Label, and Tag Text

Scaling

Feedback 90.79

Maximum/Minimum Raw Feedback

Feedback

100.00

0.00

Scaled

100.00

0.00

Maximum/Minimum Scaled CV

Actual Position 90.79

Output CV 91.00

CV Engineering Units Text

% Open

Maximum/Minimum Scaled Output

Scaled

100.00

0.00

Output

100

0

Raw Output CV 91.00

Maximum/Minimum Unscaled Output

The following table lists the functions on page 1 of the Engineering tab.

Table 17 - Engineering Tab Page 1 Description

Function	Action	Security	Configuration Parameters
	Click to navigate to the Mode Configuration display.	None	See Mode Configuration display on page 46
Description	Type the device description to show on the faceplate title bar.	Engineering Configuration (Code E)	Cfg_Desc
Label	Type the label to show on the Graphic Symbol.		Cfg_Label
Tag	Type the tag name to show on the faceplate title bar and in the tooltip. IMPORTANT: Pausing the mouse over these fields displays a tool tip with the configured Logix tag/path.		Cfg_Tag
Maximum/Minimum Raw Feedback	Type a maximum and minimum range for the raw feedback signal.		Cfg_FdbkRawMax Cfg_FdbkRawMin
Maximum/Minimum Scaled Feedback	Type a maximum and minimum range for the controlled variable in engineering units (for scaling).		Cfg_CVEUMax Cfg_CVEUMin
Units for Scaled Range	Type an engineering unit for the controlled variable.		Cfg_EU
Maximum/Minimum Scaled Output	Type a maximum and minimum range for the controlled variable in engineering units for scaling).		Cfg_CVEUMax Cfg_CVEUMin
Maximum/Minimum Unscaled Output	Type maximum and minimum range (in raw units) to use for output unscaling to I/O.		Cfg_CVRawMax Cfg_CVRawMin

Mode Configuration Display

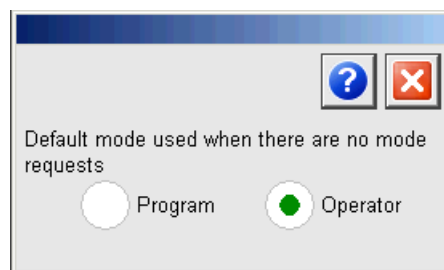

This display lets you select the default mode for the object by selecting the appropriate mode.

IMPORTANT If no mode is being requested, changing the default mode changes the mode of the instruction.

You must have FactoryTalk View security code E to select the default mode on this display.

Engineering Tab Page 2

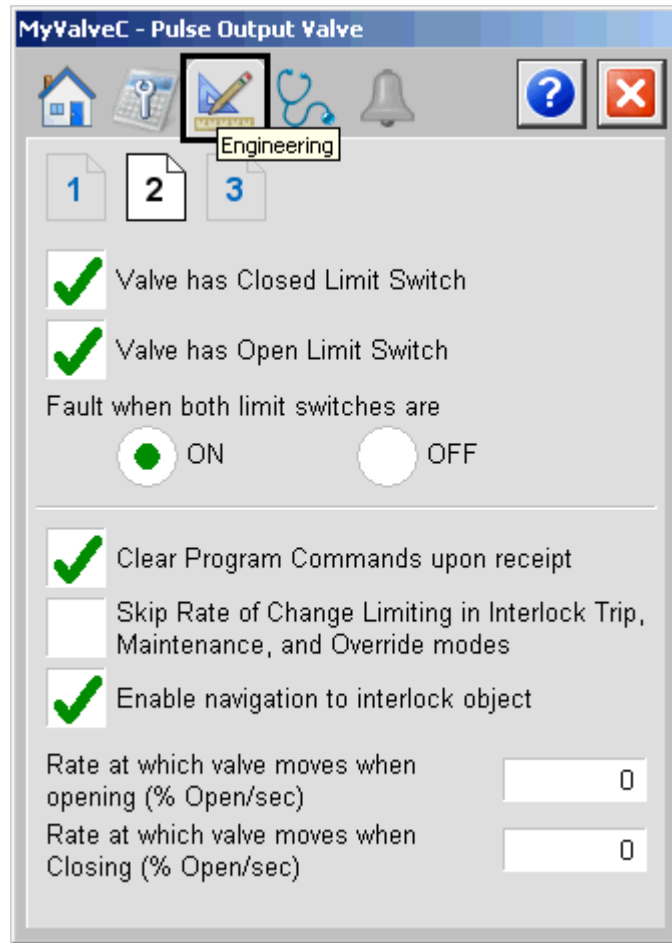

The following table shows the functions on page 2 of the Engineering tab.

Table 18 - Engineering Tab Page 2 Description

Function	Action	Security	Configuration Parameters
Valve has Closed Limit Switch	Check if the valve provides a closed limit switch signal.	Engineering Configuration (Code E)	Cfg_HasClosedLS
Valve has Open Limit Switch	Check if the valve provides an open limit switch signal.		Cfg_HasOpenLS
Fault when both limit switches are On Off	Click to enable a fault when both limit switches are On, or when both switches are Off.		Cfg_LSFail
Clear Program Commands on Receipt	Check to set this parameter to the following: <ul style="list-style-type: none"> ON to use Edge-triggered Program Commands (default). OFF to use Level-triggered Program Commands. 		Cfg_PCmdClear

Table 18 - Engineering Tab Page 2 Description

Function	Action	Security	Configuration Parameters
Skip Rate of change Limiting in Interlock Trip, Maintenance, and Override modes	Check to have the CV immediately go to its target value or configured Interlock CV value when an Interlock trips or the instruction is placed in Maintenance or Override mode. Clear the checkbox to have the CV always use rate of change limiting (ramping) of the CV output.	Engineering Configuration (Code E)	Cfg_SkipRoCLim
Enable navigation to interlock object	Check if an interlock instruction is used with this output. IMPORTANT: The name of the Interlock object in the controller must be this object's name with the suffix '_Intlk'. For example, if your P_ValveC object has the name 'ValveC123', then its Interlock object must be named 'ValveC123_Intlk'.		Cfg_HasIntlkObj
Rate at which valve moves when opening (% open per second)	Type a value to indicate the rate the value moves when opening.		Cfg_OpenRate
Rate at which valve moves when closing % open per second)	Type a value to indicate the rate the value moves when closing.		Cfg_CloseRate

If the object is configured to have an interlock object (for example, Cfg_HasIntlkObj is true), the interlock indication becomes a button that opens the faceplate of the source object used as an interlock (often this is a P_Intlk interlock object). If the object is not configured in this way, the interlock is indicator only.

See Rockwell Automation Library of Process Objects: Interlock with First Out and Bypass (P_Intlk) Reference Manual, publication [SYSLIB-RM004](#) for more information.

Engineering Tab Page 3

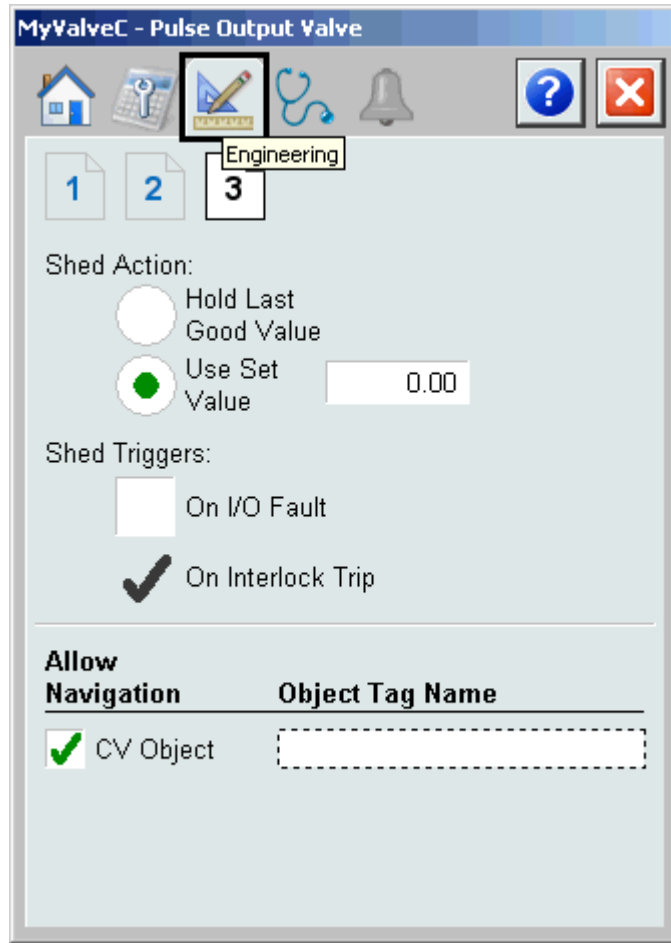

The following table shows the functions on page 3 of the Engineering tab.

Table 19 - Engineering Tab Page 3 Description

Function	Action	Security	Configuration Parameters
Shed Action: Hold Last Good Value	Click to have the output hold its current value when an Interlock trips or an I/O Fault occurs (if configured as shed trigger).	Engineering Configuration (Code E)	Cfg_ShedHold
Shed Action: Use set value	Click to have the output go to its configured Interlock CV value when an Interlock trips or an I/O Fault occurs (if configured as a shed trigger). Type a value for the interlock CV value to be used if shed is configured to go to a set value.		Cfg_IntlkCV

Table 19 - Engineering Tab Page 3 Description

Function	Action	Security	Configuration Parameters
Shed on I/O Fault	<p>Check to have the CV perform the configured Shed Action (hold or go to the Interlock CV value) when an I/O Fault occurs. When checked, the Shed Trigger is latched; that is, it is necessary to issue a Reset command to return to normal operation after the I/O Fault condition clears.</p> <p>Clear the checkbox to have an I/O Fault not trigger the configured Shed Action. The output continues to operate normally.</p>	Engineering Configuration (Code E)	Cfg_ShedOnIOFault
Shed on Interlock Trip	<p>The device always performs the shed action on an Interlock Trip. This item cannot be unchecked. It is displayed as a reminder of the Interlock Trip function.</p>		None
Allow Navigation to CV Object	<p>Check to permit navigation to the faceplate of the object which is the source of this object's CV.</p>		Cfg_HasCVNav
Object Tag name	<p>Type the name of the CV object to navigate to when the CV display on the Home tab is clicked.</p>		Cfg_CVNavTag

Diagnostics Tab

The Diagnostic tab provides indications helpful in diagnosing or preventing device problems, which can include specific reasons a device is 'Not Ready', device warnings and faults, warning and fault history, and predictive/preventive maintenance data.



The previous figure shows that the valve is not ready because the Device Logic is disabled or there is no mode.

Alarms Tab

The Alarms tab displays each configured alarm for the P_ValveC instruction. The icon on the tab for the alarms page changes color based on the current active alarms. A blinking alarm icon indicates that one or more alarms must be acknowledged or the device must be reset.

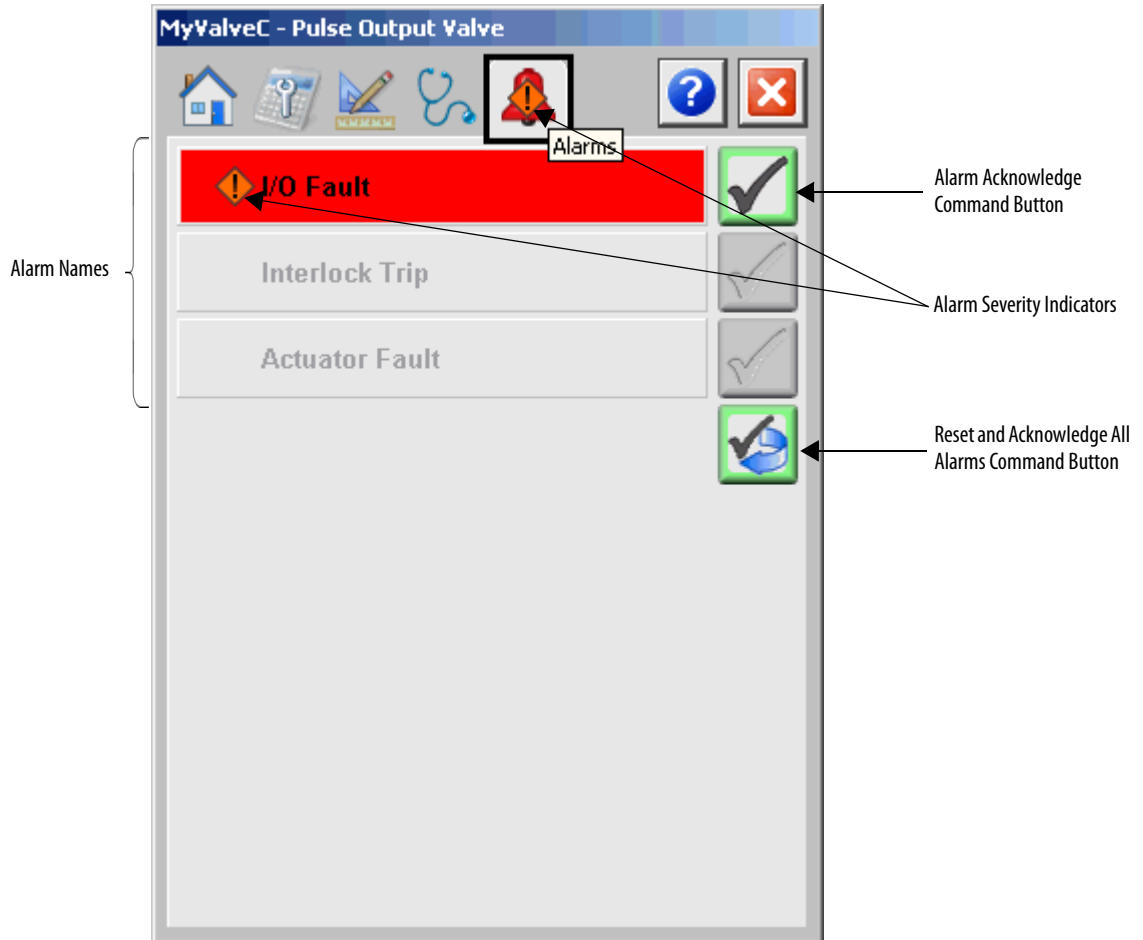

Click an alarm name to open the P_Alarm faceplate for that alarm. From the P_Alarm faceplate, you can configure and perform additional operations on the alarm.



If an alarm is active, the panel behind the alarm changes color to match the severity of the alarm. The color of the bell icon at the top of the faceplate shows the severity of the highest active alarm, and the icon blinks if any alarm is unacknowledged or requires reset.

Table 20 - Alarm Severity Colors

Color	Definition
Magenta	Urgent
Red	High
Yellow	Medium
Blue	Low
White (bell icon)	Alarm has cleared but is unacknowledged
Background (Light Gray)	No alarm

The following table shows the functions on the Alarms tab.

Table 21 - Alarms Tab Description

Function	Action	Security
Alarm Name	Click an alarm name to open the associated P_Alarm faceplate.	None
	Click to acknowledge the alarm.	Acknowledge Alarms (Code F)
	Click to reset and acknowledge all alarms.	

When the Reset and Acknowledge All Alarms button is enabled, the panel behind the alarm blinks, indicating the alarm requires acknowledgement or reset. The Alarm Acknowledge button is enabled if the alarm requires acknowledgment. Click the button with the check mark to acknowledge the alarm.

See Rockwell Automation Library of Process Objects: Common Alarm Block (P_Alarm) Reference Manual, publication [SYSLIB-RM002](#), for more information.

Analog/Pulsed Control Valve Faceplate Help

The Faceplate Help is divided into two pages.

Faceplate Help Page 1



Faceplate Help Page 2

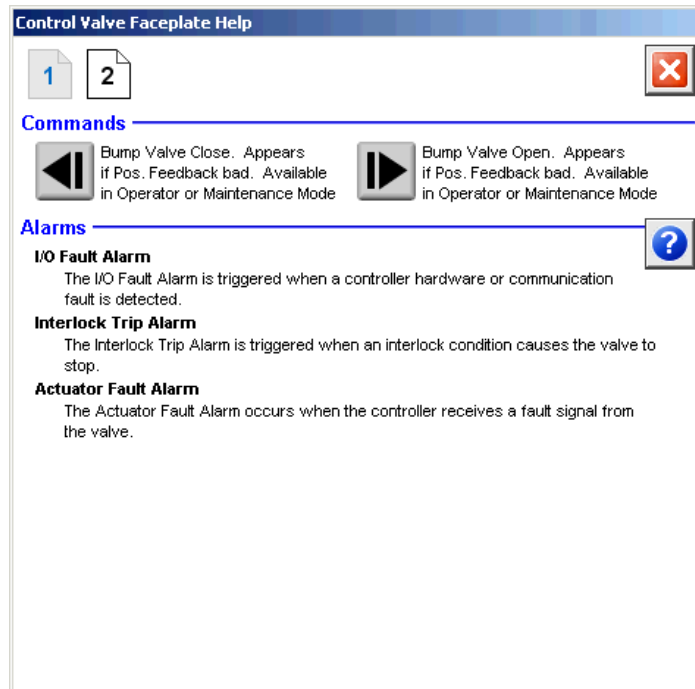

Rockwell Automation Support

Rockwell Automation provides technical information on the Web to assist you in using its products.

At <http://www.rockwellautomation.com/support> you can find technical and application notes, sample code, and links to software service packs. You can also visit our Support Center at <https://rockwellautomation.custhelp.com/> for software updates, support chats and forums, technical information, FAQs, and to sign up for product notification updates.

In addition, we offer multiple support programs for installation, configuration, and troubleshooting. For more information, contact your local distributor or Rockwell Automation representative, or visit <http://www.rockwellautomation.com/services/online-phone>.

Installation Assistance

If you experience a problem within the first 24 hours of installation, review the information that is contained in this manual. You can contact Customer Support for initial help in getting your product up and running.

United States or Canada	1.440.646.3434
Outside United States or Canada	Use the Worldwide Locator at http://www.rockwellautomation.com/rockwellautomation/support/overview.page , or contact your local Rockwell Automation representative.

New Product Satisfaction Return

Rockwell Automation tests all of its products to help ensure that they are fully operational when shipped from the manufacturing facility. However, if your product is not functioning and needs to be returned, follow these procedures.

United States	Contact your distributor. You must provide a Customer Support case number (call the phone number above to obtain one) to your distributor to complete the return process.
Outside United States	Please contact your local Rockwell Automation representative for the return procedure.

Documentation Feedback

Your comments will help us serve your documentation needs better. If you have any suggestions on how to improve this document, complete this form, publication [RA-DU002](#), available at <http://www.rockwellautomation.com/literature/>.

Rockwell Automation maintains current product environmental information on its website at <http://www.rockwellautomation.com/rockwellautomation/about-us/sustainability-ethics/product-environmental-compliance.page>.

Rockwell Otomasyon Ticaret A.Ş., Kar Plaza İş Merkezi E Blok Kat:6 34752 İçerenköy, İstanbul, Tel: +90 (216) 5698400

www.rockwellautomation.com

Power, Control and Information Solutions Headquarters

Americas: Rockwell Automation, 1201 South Second Street, Milwaukee, WI 53204-2496 USA, Tel: (1) 414.382.2000, Fax: (1) 414.382.4444
Europe/Middle East/Africa: Rockwell Automation NV, Pegasus Park, De Kleetlaan 12a, 1831 Diegem, Belgium, Tel: (32) 2 663 0600, Fax: (32) 2 663 0640
Asia Pacific: Rockwell Automation, Level 14, Core F, Cyberport 3, 100 Cyberport Road, Hong Kong, Tel: (852) 2887 4788, Fax: (852) 2508 1846

Publication SYSLIB-RM034F-EN-P - February 2019

Supersedes Publication SYSLIB-RM034E-EN-P - February 2017

Copyright © 2019 Rockwell Automation, Inc. All rights reserved. Printed in the U.S.A.