

Rockwell Automation Library of Process Objects: n-Position Device (P_nPos)

Version 3.5

IMPORTANT

This manual applies to the Rockwell Automation Library of Process Objects version 3.5 or earlier.
For Rockwell Automation Library of Process Objects version 5.0, see

- [PROCES-RM200](#)

For Rockwell Automation Library of Process Objects version 4.0 or later, use the following manuals:

- [PROCES-RM013](#) contains logic instructions
- [PROCES-RM014](#) contains display elements



Important User Information

Read this document and the documents listed in the additional resources section about installation, configuration, and operation of this equipment before you install, configure, operate, or maintain this product. Users are required to familiarize themselves with installation and wiring instructions in addition to requirements of all applicable codes, laws, and standards.

Activities including installation, adjustments, putting into service, use, assembly, disassembly, and maintenance are required to be carried out by suitably trained personnel in accordance with applicable code of practice.

If this equipment is used in a manner not specified by the manufacturer, the protection provided by the equipment may be impaired.

In no event will Rockwell Automation, Inc. be responsible or liable for indirect or consequential damages resulting from the use or application of this equipment.

The examples and diagrams in this manual are included solely for illustrative purposes. Because of the many variables and requirements associated with any particular installation, Rockwell Automation, Inc. cannot assume responsibility or liability for actual use based on the examples and diagrams.

No patent liability is assumed by Rockwell Automation, Inc. with respect to use of information, circuits, equipment, or software described in this manual.

Reproduction of the contents of this manual, in whole or in part, without written permission of Rockwell Automation, Inc., is prohibited.

Throughout this manual, when necessary, we use notes to make you aware of safety considerations.



WARNING: Identifies information about practices or circumstances that can cause an explosion in a hazardous environment, which may lead to personal injury or death, property damage, or economic loss.



ATTENTION: Identifies information about practices or circumstances that can lead to personal injury or death, property damage, or economic loss. Attentions help you identify a hazard, avoid a hazard, and recognize the consequence.

IMPORTANT

Identifies information that is critical for successful application and understanding of the product.

Labels may also be on or inside the equipment to provide specific precautions.



SHOCK HAZARD: Labels may be on or inside the equipment, for example, a drive or motor, to alert people that dangerous voltage may be present.



BURN HAZARD: Labels may be on or inside the equipment, for example, a drive or motor, to alert people that surfaces may reach dangerous temperatures.



ARC FLASH HAZARD: Labels may be on or inside the equipment, for example, a motor control center, to alert people to potential Arc Flash. Arc Flash will cause severe injury or death. Wear proper Personal Protective Equipment (PPE). Follow ALL Regulatory requirements for safe work practices and for Personal Protective Equipment (PPE).

Preface	Software Compatibility and Content Revision.....	5
	Additional Resources.....	5
n-Position Device (P_nPos)	Guidelines.....	8
	Functional Description.....	9
	Required Files.....	11
	Controller File.....	11
	Visualization Files.....	11
	Controller Code.....	13
	n-Position Device Input Structure.....	13
	n-Position Device Output Structure.....	18
	n-Position Device Local Configuration Tags.....	23
	Operations.....	24
	Modes.....	24
	Alarms.....	25
	Simulation.....	26
	Execution.....	27
	Programming Example.....	28
	Display Elements.....	30
	State Indicators.....	32
	Status/Quality Indicators.....	33
	Mode Indicators.....	34
	Alarm Indicators.....	35
	Maintenance Bypass Indicator.....	35
	Using Display Elements.....	37
	Quick Display.....	39
	Faceplate.....	39
	Operator Tab.....	40
	Maintenance Tab.....	44
	Engineering Tab.....	48
	Diagnostics Tab.....	54
	Alarms Tab.....	55
	n-Position Device Faceplate Help.....	57

Notes:

Software Compatibility and Content Revision

Table 1 - Summary of Changes

Topic	Page
Visualization Files: Global Objects (.ggfx) - Process Diagnostic Objects	12

For the latest compatible software information and to download the Rockwell Automation® Library of Process Objects, see the Product Compatibility and Download Center at <http://www.rockwellautomation.com/rockwellautomation/support/pcdc.page>.

For general library considerations, see Rockwell Automation Library of Process Objects, publication [PROCES-RM002](#).

Additional Resources

These documents contain additional information concerning related products from Rockwell Automation.

Resource	Description
PlantPAx® Distributed Control System Selection Guide, publication PROCES-SG001	Provides information to assist with equipment procurement for your PlantPAx system.
PlantPAx Distributed Control System Reference Manual, publication PROCES-RM001	Provides characterized recommendations for implementing your PlantPAx system.
Rockwell Automation Library of Process Objects, publication PROCES-RM002	Provides general considerations for the PlantPAx system library of process objects.
FactoryTalk® View Machine Edition User Manual, publication VIEWME-UM004	Provides details on how to use this software package for creating an automation application.
FactoryTalk View SE Edition User Manual, publication VIEWSE-UM006	Provides details on how to use this software package for developing and running human-machine interface (HMI) applications that can involve multiple users and servers, distributed over a network.
Logix5000™ Controllers Add-On Instructions Programming Manual, publication 1756-PM010	Provides information for designing, configuring, and programming Add-On Instructions.
Rockwell Automation Library of Process Objects: Common Alarm Block (P_Alarm) Reference Manual, publication SYSLIB-RM002	Details how to monitor an input condition to raise an alarm. Information includes acknowledging, resetting, inhibiting, and disabling an alarm. Generally the P_Alarm faceplate is accessible from the Alarms tab.
Rockwell Automation Library of Process Objects: Interlocks with First Out and Bypass (P_Intlk) Reference Manual, publication SYSLIB-RM004	Explains how to collect (sum up) the interlock conditions that stop or de-energize a running or energized piece of equipment or prevent it from starting or being energized.
Rockwell Automation Library of Process Objects: Common Mode Block (P_Mode) Reference Manual, publication SYSLIB-RM005	Explains how to choose the Mode (owner) of an instruction or control strategy. The Mode instruction is usually embedded within other instructions to extend their functionality. It is possible to use a standalone Mode instruction to enhance a program where modes are wanted.
Rockwell Automation Library of Process Objects: Permissives with Bypass (P_Perm) Reference Manual, publication SYSLIB-RM007	Details how to collect permissive conditions to start a piece of equipment.

You can view or download publications at <http://www.rockwellautomation.com/literature/>. To order paper copies of technical documentation, contact your local Allen-Bradley distributor or Rockwell Automation sales representative.

n-Position Device (P_nPos)

The P_nPos (n-Position Device) Add-On Instruction controls a circular or linear discrete device with 2...8 positions. The P_nPos instruction provides outputs to select an individual position and outputs to move toward increasing positions ('clockwise' for a circular device) or decreasing positions ('counterclockwise' for a circular device).

For linear devices, the P_nPos instruction can be configured to return to Position 1 on every move, approaching the target position from the 'same side' on each move to improve position repeatability, or move directly to the new position.

For circular devices, the P_nPos instruction can be configured to move only 'clockwise' to increase positions (for example, 6, 7, 8, 1, 2...) or both directions by using the shortest move (for example, 'clockwise' from 6...1: 6, 7, 8, 1; or 'counterclockwise' from 2...7: 2, 1, 8, 7).

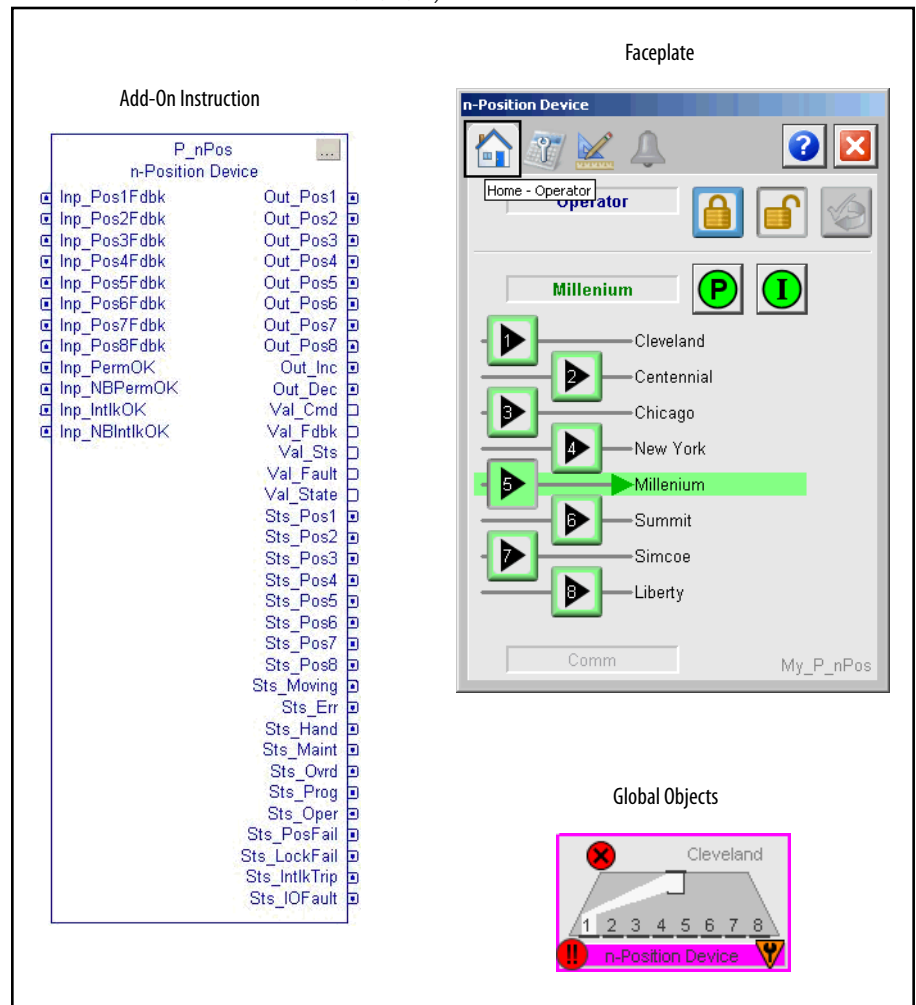

The P_nPos instruction also supports devices with a locking or sealing capability. It can unlock or unseal the device, move to the new position, then lock or seal in position.

The P_nPos instruction accepts position feedback (usually proximity or limit switches) and can alarm on failure to reach a target position in a configured time. When the locking/sealing capability is used, a lock/seal feedback can be provided and lock/unlock checking can also be performed.

The global objects and preceding faceplate are examples of the graphical interface tools for this Add-On Instruction.

Guidelines

Use this instruction in these situations:

- You want to control the position of a device with 2...8 discrete positions.
- The device accepts commands for the individual positions, increase and decrease position commands, or indexing cylinder commands.

Do **not** use this instruction in these situations:

- You want to control a simple two-state valve or two-state or three-state motor. The P_ValveMO (Motor Operated Valve), P_ValveSO (Solenoid Operated Valve), P_ValveMP (Mix Proof Valve), P_Motor (Single Speed Motor), P_Motor2Spd (Two Speed Motor), or P_MotorRev (Reversing Motor) instruction provides a better interface and better 'model' for such a device.
- You have a continuously variable position device. The P_nPos instruction works only with devices that have 2...8 discrete positions. For most final control elements that are used in process control, a P_AOut (Analog Output) or P_ValveC (Control Valve) instruction is a better choice. For high-speed motion control, such as with servo drives, use the Motion Control instruction set provided within the Logix controller firmware.

Functional Description

The diagram shows the functional characteristics of the P_nPos Add-On Instruction.

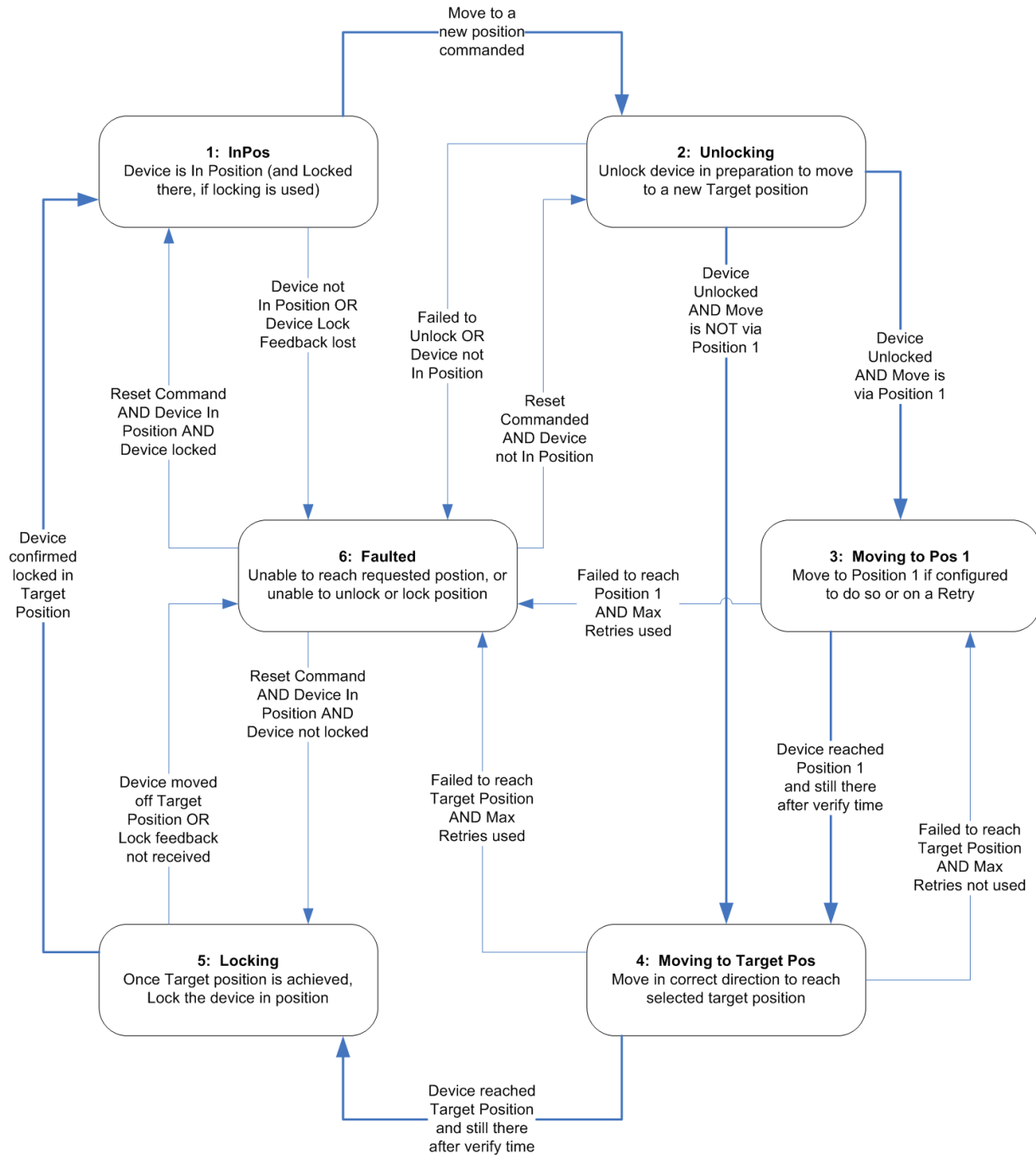

The n-Position Device instruction provides the following capabilities:

- Controls and monitors a multi-position device (up to 8 positions), such as rotary valves, and other devices with multiple fixed positions
- Monitors limit switches or other position feedback and displays actual device position
- Checks for failure to reach the requested position within a configured time. Provides Alarm on Position Failure
- Monitors Permissive conditions to allow moving to a new position
- Monitors Interlock conditions to de-energize the device, or to request the device to return to Position 1. Provides an Interlock Trip Alarm if an interlock condition causes the device to de-energize or return to Position 1
- Provides outputs to request each position, and provides outputs for increasing and decreasing position
- Provides outputs to sequence indexing cylinders for devices that use pneumatic or hydraulic devices to step through positions. The cylinders work in an Extend, Shift, Retract, Shift sequence to engage the device, and step it to the next position. The cylinder sequence reverses the Shift directions when driving circular devices 'counterclockwise' (for devices that support bidirectional operation)
- Optionally provides handling of a position lock or seal that must be driven to an unlocked or unsealed state before moving the device, and returned to a locked or sealed state after the move is completed
- If the optional lock or seal is used, provides position feedback for the lock or seal to verify the locked or unlocked state at appropriate times. Provides Alarm for Lock Failure
- Provides a simulation capability, responding as if a working device were present while keeping outputs de-energized. The simulation capability can be used for activities such as system testing, operator training, or as part of a full process simulation
- Monitors for I/O communication faults and provides an I/O Fault Alarm
- Provides an 'Available' status for use by automation logic so the logic knows when it has control of the device
- Provides maintenance capabilities, such as the ability to bypass any bypassable interlocks or permissives or temporarily disable feedback checking

Required Files

Add-On Instructions are reusable code objects that contain encapsulated logic that can streamline implementing your system. This lets you create your own instruction set for programming logic as a supplement to the instruction set provided natively in the ControlLogix® firmware. An Add-On Instruction is defined once in each controller project, and can be instantiated multiple times in your application code as needed.

Controller File

The P_nPos_3_5-00_AOIL5X Add-On Instruction must be imported into the controller project to be used in the controller configuration. The service release number (boldfaced) can change as service revisions are created.

Visualization Files

This Add-On Instruction has associated visualization files that provide a common user interface. These files can be downloaded from the Product Compatibility and Download Center at <http://www.rockwellautomation.com/rockwellautomation/support/pcdc.page>.

IMPORTANT	The visualization file dependencies require Process Library content imports to occur in a specific order as reflected in the following tables: <ul style="list-style-type: none"> • Images • Global Objects • Standard Displays • HMI Tags • Macros
------------------	--

Images are external graphic files that can be used in displays. They must be imported for FactoryTalk View to make use of them.

When PNG files are imported, they are renamed by FactoryTalk View with a .bmp file extension, but retain a .png format.

Table 2 - Visualization Files: Images (.png)

FactoryTalk View SE Software	FactoryTalk View ME Software	Description
All .png files in the images folder	All .png files in the images folder	These are the common icons used in the global objects and standard displays for all Process Objects.

The Global Object files (.ggfx file type) in the following table are Process Library display elements that are created once and referenced multiple times on multiple displays in an application. When changes are made to a Global Object, all instances in the application are automatically updated.

Table 3 - Visualization Files: Global Objects (.ggfx)

FactoryTalk View SE Software	FactoryTalk View ME Software	Description
(RA-BAS) Common Faceplate Objects	(RA-BAS-ME) Common Faceplate Objects	Global objects used on process object faceplates.
(RA-BAS) P_nPos Graphics Library	(RA-BAS-ME) P_nPos Graphics Library	n-Position global object device symbols used to build process graphics.

Table 3 - Visualization Files: Global Objects (.ggfx)

FactoryTalk View SE Software	FactoryTalk View ME Software	Description
(RA-BAS) Process Alarm Objects	(RA-BAS-ME) Process Alarm Objects	Global objects used for managing alarms on process object faceplates.
(RA-BAS) Process Diagnostic Objects	(RA-BAS-ME) Process Diagnostic Objects	Diagnostic global objects used on process object faceplates.
(RA-BAS) Process Faceplate Misc Objects	(RA-BAS-ME) Process Faceplate Misc Objects	Miscellaneous global objects used on process object faceplates.
(RA-BAS) Process Help Objects	(RA-BAS-ME) Process Help Objects	Global objects used for all process objects help displays.
(RA-BAS) Process Interlock Objects	(RA-BAS-ME) Process Interlock Objects	Global objects used for managing interlocks and permissives on process object faceplates.
(RA-BAS) Process Mode Objects	(RA-BAS-ME) Process Mode Objects	Global objects used for managing modes on process object faceplates.

The Standard Display files (.gfx file type) in the following table are the Process Library displays that you see at runtime.

Table 4 - Visualization Files: Standard Displays (.gfx)

FactoryTalk View SE Software	FactoryTalk View ME Software	Description
(RA-BAS) Common-AnalogEdit	N/A	Faceplate used for analog input data entry. The FactoryTalk View ME faceplates use the native analog input data entry so no file is required.
(RA-BAS) P_Alarm-Faceplate	(RA-BAS-ME) P_Alarm-Faceplate	The faceplate that is used for managing alarms for the object.
(RA-BAS) P_Alarm-Help	(RA-BAS-ME) P_Alarm-Help	Alarm Help information that is accessed from the P_Alarm faceplate.
(RA-BAS) P_Mode-Config	(RA-BAS-ME) P_Mode-Config	The Configuration Display used to configure the P_Mode object.
(RA-BAS) P_Mode-Help	(RA-BAS-ME) P_Mode-Help	Mode Help information that is accessed from the Help faceplate.
(RA-BAS) P_nPos-Faceplate	(RA-BAS-ME) P_nPos-Faceplate	The faceplate that is used for the object
(RA-BAS) P_nPos-Quick	(RA-BAS-ME) P_nPos-Quick	The Quick display that is used for the object
(RA-BAS) Process Discrete Family-Help	(RA-BAS-ME) Process Discrete Family-Help	The Help display for Discrete objects
(RA-BAS) P_Intlk-Faceplate	(RA-BAS-ME) P_Intlk-Faceplate	Optional The interlock faceplate used for the object. Use this file if your Discrete Output has an associated P_Intlk object and you enable navigation to its faceplate from the Discrete Output faceplate.
(RA-BAS) P_Perm-Faceplate	(RA-BAS-ME) P_Perm-Faceplate	Optional Permissive faceplate that is used for the object Use this file if your object has an associated P_Perm object and you enable navigation to the P_Perm faceplate from the object faceplate.
(RA-BAS) Process Interlock Family-Help	(RA-BAS-ME) Process Interlock Family-Help	Optional Interlock/permissives help display that is used for the object Use this file if you use the P_Intlk or P_Perm faceplate.

HMI Tags are created in a FactoryTalk View ME application to support tab switching on Process Library faceplates. The HMI tags may be imported via the comma-separated values file (.csv file type) in the following table.

Table 5 - Visualization Files: HMI Tags (.csv)

FactoryTalk View SE Software	FactoryTalk View ME Software	Description
N/A	FTVME_PlantPaxLib_Tags_3_5_XX.csv where XX = the service release number.	These tags must be imported into the FactoryTalk View ME project to support switching tabs on any Process Object faceplate.

Controller Code

This section describes the parameter references for this Add-On Instruction.

n-Position Device Input Structure

Input parameters include the following:

- Input data elements (Inp_) are typically used to connect field inputs from I/O modules or signals from other objects.
- Configuration data elements (Cfg_) are used to set configurable capabilities and features of the instruction.
- Command data elements (PCmd_, OCmd_, MCmd_) are used by program logic, operators, and maintenance personnel to request instruction actions.
- Setting data elements (PSet_) are used by program logic to establish runtime setpoints, thresholds, and so forth.

Table 6 - P_nPos Input Parameters

Input Parameter	Data Type	Alias For	Default	Description
EnableIn	BOOL		1	<p>Ladder Diagram: If the rung-in condition is true, the instruction's Logic routine executes. If the rung-in condition is false, the instruction's EnableInFalse routine executes.</p> <p>Function Block Diagram: If true, or not connected, the instruction's Logic routine executes. If the parameter is exposed as a pin and wired, and the pin is false, the instruction's EnableInFalse routine executes.</p> <p>Structured Text: No effect. The instruction's Logic routine executes.</p>
Inp_Pos1Fdbk	BOOL		0	Position feedback. The parameter Cfg_HasPosFdbk determines if these parameters are used. 1 = Device confirmed at position.
Inp_Pos2Fdbk				
Inp_Pos3Fdbk				
Inp_Pos4Fdbk				
Inp_Pos5Fdbk				
Inp_Pos6Fdbk				
Inp_Pos7Fdbk				
Inp_Pos8Fdbk				
Inp_LockFdbk	BOOL		0	1 = Device confirmed Locked/Sealed In-Position.

Table 6 - P_nPos Input Parameters

Input Parameter	Data Type	Alias For	Default	Description
Inp_UnlockFdbk	BOOL		0	1 = Device confirmed Unlocked/Unsealed and free to move.
Inp_CylExtFdbk	BOOL		0	1 = Device indexing cylinder confirmed extended.
Inp_CylRetrFdbk	BOOL		0	1 = Device indexing cylinder confirmed retracted.
Inp_CylLeftFdbk	BOOL		0	1 = Device indexing cylinder confirmed in left position.
Inp_CylRightFdbk	BOOL		0	1 = Device indexing cylinder confirmed in right position.
Inp_PermOK	BOOL		1	1 = Permissives OK, device can energize.
Inp_NBPermOK	BOOL		1	1 = Non-bypassable permissives OK, device can energize.
Inp_IntlkOK	BOOL		1	1 = Interlocks OK, device can energize.
Inp_NBIntlkOK	BOOL		1	1 = Non-bypassable Interlocks OK, device can energize.
Inp_IOFault	BOOL		0	I/O communication status: 0 = OK 1 = Failure
Inp_Sim	BOOL		0	Simulation input. When set to 1, the instruction simulates a working device while keeping outputs de-energized. When set to 0, the instruction controls the device normally.
Inp_Hand	BOOL	Mode.Inp_Hand	0	1 = Select Hand (hard-wired) mode.
Inp_Ovrd	BOOL	Mode.Inp_Ovrd	0	1 = Select Override mode.
Inp_OvrdCmd	SINT		0	Position command in Override mode: 0 = Stay 1 = Position 1 2 = Position 2 3 = Position 3 4 = Position 4 5 = Position 5 6 = Position 6 7 = Position 7 8 = Position 8
Inp_Reset	BOOL		0	Input parameter used to programatically reset alarms. When set to 1, all alarms requiring reset are reset.
Cfg_NumPos	DINT		3	Number of device positions (2...8).
Cfg_Circ	BOOL		0	Selects circular or linear for the device type: 0 = Positions are linear 1 = Positions are circular (rotary device, the last position is adjacent to position 1)
Cfg_CWOnly	BOOL		0	1 = Circular (rotary) device can rotate 'clockwise' only. 0 = Bidirectional (use shortest path).
Cfg_ViaPos1	BOOL		0	1 = Drive linear device to Position 1 on every move. 0 = Move direct to command position.
Cfg_IntlkToPos1	BOOL		0	1 = Drive to Position 1 on interlock or fault. 0 = De-energize only.
Cfg_OutPosLatch	BOOL		0	1 = Latch in Out_PosX until new position commanded. 0 = De-energize Out_PoxX once target position is reached.
Cfg_HasLock	BOOL		0	1 = Must sequence a position lock or seal (sets Out_Unlock to move and Out_Lock when move complete).
Cfg_HasPosFdbk	BOOL		0	1 = Device has feedback for all positions.
Cfg_UsePosFdbk	BOOL		0	1 = Position feedback shall be used to check device position.
Cfg_HasLockFdbk	BOOL		0	1 = Device has locked/unlocked feedback.

Table 6 - P_nPos Input Parameters

Input Parameter	Data Type	Alias For	Default	Description
Cfg_UseLockFdbk	BOOL		0	1 = Lock Feedback shall be used to verify locking and unlocking.
Cfg_HasCylFdbk	BOOL		0	1 = Device indexing cylinders have position feedback.
Cfg_UseCylFdbk	BOOL		0	1 = Indexing cylinder position feedback shall be checked.
Cfg_HasPermObj	BOOL		0	1 = Tells HMI a permissive object (for example, P_Perm) is used for P_PermOK and navigation to the permissive object's faceplate is enabled. IMPORTANT: The name of the Permissives object in the controller must be this object's name with the suffix '_Perm'. For example, if your P_nPos object has the name 'nPos123', then its Permissives object must be named 'nPos123_Perm'.
Cfg_HasIntlkObj	BOOL		0	1 = Tells HMI an interlock object (for example, P_Intlk) is used for Inp_IntlkOK and navigation to the interlock object's faceplate is enabled. IMPORTANT: The name of the interlock object in the controller must be this object's name with the suffix '_Intlk'. For example, if your P_nPos object has the name 'nPos123', then its interlock object must be named 'nPos123_Intlk'.
Cfg_PCmdClear	BOOL	Mode.Cfg_PCmdClear	1	When this parameter is 1, program commands are cleared once they are acted upon. When set to 0, program commands remain set until cleared by the application program logic.
Cfg_ProgDefault	BOOL	Mode.Cfg_ProgDefault	0	This parameter defines the default mode. When this parameter is 1, the mode defaults to Program if no mode is being requested. When this parameter is 0, the mode defaults to Operator if no mode is being requested.
Cfg_OCcmdResets	BOOL		0	1 = New Operator position command resets fault. 0 = Reset required to clear fault.
Cfg_CmdDuringMove	BOOL		0	1 = New position command OK during move. 0 = Must wait for previous command to finish.
Cfg_OvrPermIntlk	BOOL		0	1 = Override ignores bypassable permissives/interlocks. 0 = Always use permissives/interlocks.
Cfg_ShedOnPosFail	BOOL		0	1 = De-energize device and alarm on Position Fail. 0 = Alarm only. IMPORTANT: When this option is 1 and a position fail condition occurs, a reset is required before the device can be energized.
Cfg_ShedOnLockFail	BOOL		0	1 = De-energize device and alarm on Lock Fail. 0 = Alarm only. IMPORTANT: When this option is 1 and a lock fail condition occurs, a reset is required before the device can be energized.
Cfg_ShedOnIOFault	BOOL		0	1 = De-energize device and alarm on I/O Fault. 0 = Alarm only. IMPORTANT: When this option is 1 and an I/O Fault condition occurs, a reset is required before the device can be energized.
Cfg_HasPosFailAlm	BOOL	PosFail.Cfg_Exists	0	These parameters determine whether the corresponding alarm exists and is checked or if the alarm does not exist and is not used. When these parameters are 1, the corresponding alarm exists.
Cfg_HasLockFailAlm		LockFail.Cfg_Exists		
Cfg_HasIntlkTripAlm		IntlkTrip.Cfg_Exists		
Cfg_HasIOFaultAlm		IOFault.Cfg_Exists		
Cfg_PosFailResetReqd	BOOL	PosFail.Cfg_ResetReqd	0	These parameters determine whether a reset is required to clear the alarm status. When these parameters are 1, the alarm is latched ON when the alarm occurs. After the alarm condition returns to normal, a reset is required to clear the alarm status (for example, OCcmd_Reset, Inp_Reset, or Hi.OCcmd_Reset is required to clear Alm_Hi alarm after the alarm is set and the value returns to normal). When these parameters are 0, no reset is required and the alarm status is cleared when the alarm condition returns to normal. IMPORTANT: If the reset clears the alarm, it also acknowledges the alarm.
Cfg_LockFailResetReqd		LockFail.Cfg_ResetReqd		
Cfg_IntlkTripResetReqd		IntlkTrip.Cfg_ResetReqd		
Cfg_IOFaultResetReqd		IOFault.Cfg_ResetReqd		

Table 6 - P_nPos Input Parameters

Input Parameter	Data Type	Alias For	Default	Description
Cfg_PosFailAckReqd	BOOL	PosFail.Cfg_AckReqd	1	These parameters determine whether an acknowledgement is required for an alarm. When these parameters are 1, the acknowledge (ack) bit is cleared when the alarm occurs. An acknowledge command (for example, PCmd_FailAck or Fail.OCmd_Ack) is required to acknowledge the alarm. When set to 0, the Acknowledge bit is set when an alarm occurs indicating an acknowledged alarm and no acknowledge command is required.
Cfg_LockFailAckReqd		LockFail.Cfg_AckReqd		
Cfg_IntlkTripAckReqd		IntlkTrip.Cfg_AckReqd		
Cfg_IOFaultAckReqd		IOFault.Cfg_AckReqd		
Cfg_PosFailSeverity	INT	PosFail.Cfg_Severity	1000	These parameters determine the severity of each alarm. This drives the color and symbol that are used to indicate alarm status on the faceplate and global object. The following are valid values: 1...250 = Low 251...500 = Medium 501...750 = High 751...1000 = Urgent IMPORTANT: For FactoryTalk View software version 7.0, these severity parameters drive only the indication on the global object and faceplate. The Alarms and Events definition severity drives the color and symbol that is used on the alarm banner and alarm summary as well as the value returned by the FactoryTalk Alarms and Events display commands.
Cfg_LockFailSeverity		LockFail.Cfg_Severity	1000	
Cfg_IntlkTripSeverity		IntlkTrip.Cfg_Severity	500	
Cfg_IOFaultSeverity		IOFault.Cfg_Severity	1000	
Cfg_Retries	SINT		0	Number of retries via Position 1 before declaring failure (0=don't retry).
Cfg_ExtendT	REAL		0.0	Delay before extending cylinder to engage for move (seconds).
Cfg_VerifyT	REAL		1.0	Delay to verify device has settled in commanded position (seconds).
Cfg_PosChkT	DINT		30	Maximum time to reach target position before fail (seconds).
Cfg_LockChkT	DINT		5	Maximum time to get locked /unlocked feedback before fail (seconds).
Cfg_PosSimT	REAL		1.0	Time to reach target position in simulation (seconds).
Cfg_LockSimT	REAL		1.0	Time to lock or unlock in simulation (seconds).
Cfg_CylSimT	REAL		1.0	Time to simulate index cylinder feedback in simulation (seconds).
PSet_Owner	DINT		0	Program owner request ID (non-zero) or release (zero).
PCmd_Pos1	BOOL		0	When Cfg_PCmdClear is 1: <ul style="list-style-type: none"> Set PCmd_Pos1 to 1 to go to Position 1 Set PCmd_Pos2 to 1 to go to Position 2 Set PCmd_Pos3 to 1 to go to Position 3 Set PCmd_Pos4 to 1 to go to Position 4 Set PCmd_Pos5 to 1 to go to Position 5 Set PCmd_Pos6 to 1 to go to Position 6 Set PCmd_Pos7 to 1 to go to Position 7 Set PCmd_Pos8 to 1 to go to Position 8 These parameters reset automatically When Cfg_PCmdClear is 0: <ul style="list-style-type: none"> Set PCmd_Pos1 to 1 to go to Position 1 Set PCmd_Pos2 to 1 to go to Position 2 Set PCmd_Pos3 to 1 to go to Position 3 Set PCmd_Pos4 to 1 to go to Position 4 Set PCmd_Pos5 to 1 to go to Position 5 Set PCmd_Pos6 to 1 to go to Position 6 Set PCmd_Pos7 to 1 to go to Position 7 Set PCmd_Pos8 to 1 to go to Position 8 These parameters do not reset automatically
PCmd_Pos2				
PCmd_Pos3				
PCmd_Pos4				
PCmd_Pos5				
PCmd_Pos6				
PCmd_Pos7				
PCmd_Pos8				
PCmd_Acq	BOOL	Mode.PCmd_Acq	0	When Cfg_PCmdClear is 1: <ul style="list-style-type: none"> Set PCmd_Acq to 1 to Acquire Set PCmd_Rel to 1 to Release These parameters reset automatically When Cfg_PCmdClear is 0: <ul style="list-style-type: none"> Set PCmd_Acq to 1 to Acquire Set PCmd_Acq to 0 to Release PCmd_Rel is not used These parameters do not reset automatically
PCmd_Rel		Mode.PCmd_Rel		

Table 6 - P_nPos Input Parameters

Input Parameter	Data Type	Alias For	Default	Description
PCmd_Lock	BOOL	Mode.PCmd_Lock	0	When Cfg_PCmdClear is 1: <ul style="list-style-type: none"> Set PCmd_Lock to 1 to Lock Set PCmd_Unlock to 1 to Unlock These parameters reset automatically When Cfg_PCmdClear is 0: <ul style="list-style-type: none"> Set PCmd_Lock to 1 to Lock Set PCmd_Lock to 0 to Unlock PCmd_Unlock is not used These parameters do not reset automatically
PCmd_Unlock		Mode.PCmd_Unlock		
PCmd_Reset	BOOL		0	<ul style="list-style-type: none"> Set PCmd_Reset to 1 to reset all alarms requiring reset This parameter is always reset automatically
PCmd_PosFailAck	BOOL	PosFail.PCmd_Ack	0	<ul style="list-style-type: none"> Set PCmd_<Alarm>Ack to 1 to Acknowledge alarm The parameter is reset automatically
PCmd_LockFailAck		LockFail.PCmd_Ack		
PCmd_IntlkTripAck		IntlkTrip.PCmd_Ack		
PCmd_IOFaultAck		IOFault.PCmd_Ack		
PCmd_PosFailSuppress	BOOL	PosFail.PCmd_Suppress	0	When Cfg_PCmdClear is 1: <ul style="list-style-type: none"> Set PCmd_<Alarm>Suppress to 1 to suppress alarm Set PCmd_<Alarm>Unsuppress to 1 to unsuppress alarm These parameters reset automatically When Cfg_PCmdClear is 0: <ul style="list-style-type: none"> Set PCmd_<Alarm>Suppress to 1 to suppress alarm Set PCmd_<Alarm>Suppress to 0 to unsuppress alarm PCmd_<Alarm>Unsuppress is not used These Parameters do not reset automatically
PCmd_LockFailSuppress		LockFail.PCmd_Suppress		
PCmd_IntlkTripSuppress		IntlkTrip.PCmd_Suppress		
PCmd_IOFaultSuppress		IOFault.PCmd_Suppress		
PCmd_PosFailUnsuppress	BOOL	PosFail.PCmd_Unsuppress	0	When Cfg_PCmdClear is 1: <ul style="list-style-type: none"> Set PCmd_<Alarm>Suppress to 1 to suppress alarm Set PCmd_<Alarm>Suppress to 0 to unsuppress alarm PCmd_<Alarm>Unsuppress is not used These Parameters do not reset automatically
PCmd_LockFailUnsuppress		LockFail.PCmd_Unsuppress		
PCmd_IntlkTripUnsuppress		IntlkTrip.PCmd_Unsuppress		
PCmd_IOFaultUnsuppress		IOFault.PCmd_Unsuppress		
PCmd_PosFailUnshelve	BOOL	PosFail.PCmd_Unshelve	0	<ul style="list-style-type: none"> Set PCmd_<Alarm>Unshelve to 1 to Unshelve alarm The parameter is reset automatically
PCmd_LockFailUnshelve		LockFail.PCmd_Unshelve		
PCmd_IntlkTripUnshelve		IntlkTrip.PCmd_Unshelve		
PCmd_IOFaultUnshelve		IOFault.PCmd_Unshelve		
OCmd_Pos1	BOOL		0	Operator command to position.
OCmd_Pos2				
OCmd_Pos3				
OCmd_Pos4				
OCmd_Pos5				
OCmd_Pos6				
OCmd_Pos7				
OCmd_Pos8				
OCmd_Bypass	BOOL		0	Operator command to bypass all bypassable interlocks and permissives.
OCmd_Check	BOOL		0	Operator command to check (not bypass) all interlocks and permissives.
MCmd_Disable	BOOL	Mode.MCmd_Acq	0	Maintenance command to disable device, enable (allow to energize), acquire ownership (Operator/Program/Override to Maintenance), or release ownership (Maintenance to Operator/Program/Override).
MCmd_Enable		Mode.MCmd_Rel		
MCmd_Acq		Mode.OCmd_AcqLock		
MCmd_Rel		Mode.OCmd_UnlockRel		
OCmd_AcqLock	BOOL		0	Operator command to acquire (Program to Operator)/lock ownership.

Table 6 - P_nPos Input Parameters

Input Parameter	Data Type	Alias For	Default	Description
OCmd_Unlock	BOOL		0	Operator command to unlock/release (Operator to Program) ownership.
OCmd_Reset	BOOL		0	Operator command to reset all alarms requiring reset.
OCmd_ResetAckAll	BOOL		0	Operator command to reset and acknowledge all alarms and latched shed conditions.

n-Position Device Output Structure

Output parameters include the following:

- Output data elements (Out_) are the primary outputs of the instruction, typically used by hardware output modules; however, they can be used by other application logic.
- Value data elements (Val_) are numeric outputs of the instruction for use by the HMI. Values can also be used by other application logic or software packages.
- Source and Quality data elements (SrcQ_) are outputs of the instruction used by the HMI to indicate PV source and quality.
- Status data elements (Sts_) are bit outputs of the instruction for use by the HMI. Status bits can also be used by other application logic.
- Error data elements (Err_) are outputs of the instruction that indicate a particular configuration error. If any Err_ bit is set, then the Sts_Err configuration error summary status is set and the Invalid Configuration indicator is displayed on the HMI.
- Not Ready data elements (Nrdy_) are bit outputs of the instruction for use by the HMI for displaying the Device Not Ready indicator. Status bits can also be used by other application logic.
- Alarm data elements (Alm_) are outputs of the instruction that indicate a particular alarm has occurred.
- Acknowledge data elements (Ack_) are outputs of the instruction that indicate the corresponding alarm has been acknowledged.
- Ready data elements (Rdy_) are bit outputs of the instruction used by the HMI to enable or disable command buttons and set data entry fields.

Table 7 - P_nPos Output Parameters

Output Parameter	Data Type	Alias For	Description
EnableOut	BOOL		Enable output: The EnableOut signal is not manipulated by this instruction. Its output state always reflects EnableIn input state.

Table 7 - P_nPos Output Parameters

Output Parameter	Data Type	Alias For	Description
Out_Pos1	BOOL		Output to go to Position 1...8.
Out_Pos2			
Out_Pos3			
Out_Pos4			
Out_Pos5			
Out_Pos6			
Out_Pos7			
Out_Pos8			
Out_Inc	BOOL		Output to drive to Increasing Position ('clockwise').
Out_Dec	BOOL		Output to drive to Decreasing Position ('counterclockwise').
Out_Unlock	BOOL		Output to unlock /unseal device.
Out_Lock	BOOL		Output to lock /seal device.
Out_CylExtend	BOOL		Output to extend cylinder to engage ratchet device.
Out_CylRetract	BOOL		Output to retract cylinder to disengage ratchet device.
Out_CylLeft	BOOL		Output to ratchet device to left (increase).
Out_CylRight	BOOL		Output to ratchet device to right (decrease).
SrcQ_IO	BOOL		I/O signal source and quality.
SrcQ			Final position source and quality. GOOD 0 = I/O live and confirmed good quality 1 = I/O live and assumed good quality 2 = No feedback configured, assumed good quality TEST 8 = Device simulated 9 = Device loopback simulation 10 = Manually entered value UNCERTAIN 16 = Live input, off-specification 17 = Value substituted at device/bus 18 = Value substituted by maintenance (Has and not Use) 19 = Shed, using last good value 20 = Shed, using replacement value BAD 32 = Signal failure (out-of-range, NaN, invalid combination) 33 = I/O channel fault 34 = I/O module fault 35 = Bad I/O configuration (for example, scaling parameters)
Val_Cmd	SINT		Device command: 0 = None 1 = Position 1 2 = Position 2 3 = Position 3 4 = Position 4 5 = Position 5 6 = Position 6 7 = Position 7 8 = Position 8

Table 7 - P_nPos Output Parameters

Output Parameter	Data Type	Alias For	Description
Val_Fdbk	SINT		Device feedback: 0 = Moving 1 = Position 1 2 = Position 2 3 = Position 3 4 = Position 4 5 = Position 5 6 = Position 6 7 = Position 7 8 = Position 8 9 = Multiple positions
Val_Sts	SINT		Device confirmed status: 0 = Powerup/Reset 1 = Position 1 2 = Position 2 3 = Position 3 4 = Position 4 5 = Position 5 6 = Position 6 7 = Position 7 8 = Position 8 9 = Moving 33 = Disabled
Val_Fault	SINT		Device fault status: 0 = None 16 = Position Fault 17 = Lock Fault 32 = I/O Fault 34 = Configuration Error
Val_State	SINT		Internal state (see diagram on page 9): 0 = Reset/unknown 1 = In position 2 = Unlocking 3 = Moving to position 1 4 = Moving to commanded position 5 = Locking 6 = Fault
Val_Mode	SINT	Mode.Val	The current mode is shown with status bits and also as an enumeration 'Val_Mode' as follows: 0 = No mode 1 = Hand 2 = Maintenance 3 = Override 4 = Program (locked) 5 = Operator (locked) 6 = Program (unlocked, Operator is default) 7 = Operator (unlocked, Program is default) 8 = Program (unlocked, Program is default) 9 = Operator (unlocked, Operator is default)
Val_Owner	DINT		Current object owner ID (0 = not owned).

Table 7 - P_nPos Output Parameters

Output Parameter	Data Type	Alias For	Description
Val_Notify	SINT		Current alarm level and acknowledgement (enumeration): 0 = No alarm 1 = Alarm cleared: a reset or acknowledge is required 2 = Low (acknowledged) 3 = Low (unacknowledged) 4 = Medium (acknowledged) 5 = Medium (unacknowledged) 6 = High (acknowledged) 7 = High (unacknowledged) 8 = Urgent (acknowledged) 9 = Urgent (unacknowledged)
Sts_Pos1	BOOL		1 = Device confirmed in Position 1...8.
Sts_Pos2			
Sts_Pos3			
Sts_Pos4			
Sts_Pos5			
Sts_Pos6			
Sts_Pos7			
Sts_Pos8			
Sts_Moving	BOOL		1 = Device moving to target position, not yet achieved.
Sts_Available	BOOL		1 = Device available for control by automation (Program).
Sts_Bypass	BOOL		1 = Bypassable interlocks and permissives are bypassed.
Sts_BypActive	BOOL		1 = Bypassing active (bypassed or maintenance).
Sts_Disabled	BOOL		1 = Device is disabled.
Sts_NotRdy	BOOL		1 = Device is Not Ready (independent of mode).
Nrdy_Disabled	BOOL		1 = Device Not Ready: <ul style="list-style-type: none"> • Device Disabled by Maintenance • Configuration Error • Interlock Not OK • Permissive Not OK • Operator State 0 Priority Command Requires Reset • Device Failure (Shed Requires Reset) • I/O Fault (Shed Requires Reset) • Device Logic Disabled / NO Mode
Nrdy_CfgErr			
Nrdy_Intlk			
Nrdy_Perm			
Nrdy_Fail			
Nrdy_IOFault			
Nrdy_NoMode			
Sts_MaintByp	BOOL		1 = Maintenance bypass is active, display icon.
Sts_Almlnh	BOOL		1 = An alarm is shelved, disabled or suppressed, display icon.
Sts_Err	BOOL		1 = Error in configuration: see detail bits for reason.
Err_NumPos	BOOL		1 = Error in configuration: Invalid number of positions (use 2...8).
Err_Fail	BOOL		1 = Error in configuration: Invalid failure (check) time (use 0...2,147,483).
Err_Timer	BOOL		1 = Error in configuration: Invalid delay time (use 0...2,147,483).
Err_Sim	BOOL		1 = Error in configuration: Invalid simulation time (use 0...2,147,483).
Err_Alarm	BOOL		1 = Error in configuration: Alarm minimum ON time or severity.
Sts_Hand	BOOL	Mode.Sts_Hand	1 = Mode is Hand (supersedes Maintenance, Override, Program, Operator).
Sts_Maint	BOOL	Mode.Sts_Maint	1 = Mode is Maintenance (supersedes Override, Program, Operator).

Table 7 - P_nPos Output Parameters

Output Parameter	Data Type	Alias For	Description
Sts_Ovrd	BOOL	Mode.Sts_Ovrd	1 = Mode is Override (supersedes Program, Operator).
Sts_Prog	BOOL	Mode.Sts_Prog	1 = Mode is Program (auto).
Sts_Oper	BOOL	Mode.Sts_Oper	1 = Mode is Operator (manual).
Sts_ProgOperLock	BOOL	Mode.Sts_ProgOperLock	1 = Program or Operator has requested Mode Lock.
Sts_NoMode	BOOL	Mode.Sts_NoMode	1 = No mode (disabled because EnableIn is False).
Sts_MAcqRcvd	BOOL	Mode.Sts_MAcqRcvd	1 = Maintenance Acquire command received this scan.
Sts_PosFail	BOOL	PosFail.Inp	Position failure status: 0 = OK 1 = Failed to reach target position.
Sts_LockFail	BOOL	LockFail.Inp	Lock /unlock failure status: 0 = OK 1 = Bad
Sts_IntlkTrip	BOOL	IntlkTrip.Inp	1 = Device de-energized by an interlock Not OK.
Sts_IOFault	BOOL	IOFault.Inp	I/O communication fault status: 0 = OK 1 = Bad
Alm_PosFail	BOOL	PosFail.Alm	1 = Position failure alarm, Lock/unlock failure alarm, Alarm: Device de-energized by an interlock Not OK, or I/O Fault alarm.
Alm_LockFail		LockFail.Alm	
Alm_IntlkTrip		IntlkTrip.Alm	
Alm_IOFault		IOFault.Alm	
Ack_PosFail	BOOL	PosFail.Ack	1 = Position failure alarm, Lock/unlock failure alarm, Interlock trip alarm, or I/O Fault alarm has been acknowledged.
Ack_LockFail		LockFail.Ack	
Ack_IntlkTrip		IntlkTrip.Ack	
Ack_IOFault		IOFault.Ack	
Sts_PosFailDisabled	BOOL	PosFail.Disabled	1 = Position failure alarm, Lock/unlock failure alarm, Interlock trip alarm, or I/O Fault alarm is disabled by Maintenance.
Sts_LockFailDisabled		LockFail.Disabled	
Sts_IntlkTripDisabled		IntlkTrip.Disabled	
Sts_IOFaultDisabled		IOFault.Disabled	
Sts_PosFailShelved	BOOL	PosFail.Shelved	1 = Position failure alarm, Lock/unlock failure alarm, Interlock trip alarm, or I/O Fault alarm, is shelved by Operator.
Sts_LockFailShelved		LockFail.Shelved	
Sts_IntlkTripShelved		IntlkTrip.Shelved	
Sts_IOFaultShelved		IOFault.Shelved	
Sts_PosFailSuppressed	BOOL	PosFail.Suppressed	1 = Position failure alarm, Lock/unlock failure alarm, Interlock trip alarm, or I/O Fault alarm is suppressed by Program.
Sts_LockFailSuppressed		LockFail.Suppressed	
Sts_IntlkTripSuppressed		IntlkTrip.Suppressed	
Sts_IOFaultSuppressed		IOFault.Suppressed	

Table 7 - P_nPos Output Parameters

Output Parameter	Data Type	Alias For	Description
Rdy_Pos1	BOOL		1 = Ready to receive OCmd_Pos1...Pos8 (enables HMI button).
Rdy_Pos2			
Rdy_Pos3			
Rdy_Pos4			
Rdy_Pos5			
Rdy_Pos6			
Rdy_Pos7			
Rdy_Pos8			
Rdy_Bypass	BOOL		1 = Ready to receive OCmd_Bypass, OCmd_Check, MCmd_Disable, and MCmd_Enable (enables HMI button).
Rdy_Check			
Rdy_Disable			
Rdy_Enable			
Rdy_Reset	BOOL		1 = At least one alarm or latched shed requires reset.
Rdy_ResetAckAll	BOOL		1 = At least one alarm or latched shed condition requires reset or acknowledged.
P_nPos	BOOL		Unique parameter name for auto-discovery.

n-Position Device Local Configuration Tags

Configuration parameters that are arrayed, string, or structure data types cannot be configured as parameters for Add-On Instructions. Configuration parameters of these types appear as local tags to the Add-On Instruction. Local tags can be configured through the HMI faceplates or in Studio 5000 Logix Designer® application by opening the Instruction Logic of the Add-On Instruction instance and then opening the Data Monitor on a local tag. These parameters cannot be modified by using controller logic or Logix Designer application export/import functionality.

Table 8 - Local Configuration Tags

Tag Name	Data Type	Default	Description
Cfg_Desc	STRING_40	'n-Position Device'	Description for display on HMI. This string is shown in the title bar of the faceplate.
Cfg_Label	STRING_20	'n-Position Device'	Label for graphic symbol displayed on HMI. This string appears on the graphic symbol.
Cfg_Pos1Name	STRING_16	'Position 1'	Description for Position 1...8 on HMI.
Cfg_Pos2Name		'Position 2'	
Cfg_Pos3Name		'Position 3'	
Cfg_Pos4Name		'Position 4'	
Cfg_Pos5Name		'Position 5'	
Cfg_Pos6Name		'Position 6'	
Cfg_Pos7Name		'Position 7'	
Cfg_Pos8Name		'Position 8'	
Cfg_Tag	STRING_20	'P_nPos'	Description for display on HMI. This string is shown in the title bar of the faceplate.

Operations

This section describes the primary operations for Add-On Instructions.

Modes

This instruction uses the following standard modes, which are implemented by using an embedded P_Mode Add-On Instruction.

Table 9 - Modes

Mode	Description
Operator	The Operator owns control of the device. Operator commands (OCmd_) and Operator settings (OSet_) from the HMI are accepted.
Program	Program logic owns control of the device. Program commands (PCmd_) and Program settings (PSet_) are accepted.
Override	Priority logic owns control of the device and supersedes Operator and Program control. Override Inputs (Inp_OvrCmd and other Inp_OvrDxxx values) are accepted. If so configured, bypassable interlocks and permissives are bypassed.
Maintenance	Maintenance owns control of the device and supersedes Operator, Program, and Override control. Operator commands and settings from the HMI are accepted. Bypassable interlocks and permissives are bypassed, and device timeout checks are not processed.
Hand	Hardwired logic or other logic outside the instruction owns control of the device. The instruction tracks the state of the device for bumpless transfer back to one of the other modes.
No Mode	The device is disabled and has no owner because the EnableIn input is false. The main instruction Logic routine is not being scanned. See Execution section for more information on EnableInFalse processing.

See Rockwell Automation Library of Process Objects: Common Mode Block (P_Mode) Reference Manual, publication [SYSLIB-RM005](#), for more information.

Alarms

This instruction uses the following alarms, which are implemented by using embedded P_Alarm and P_Gate Add-On Instructions.

Alarm Name	P_Alarm Name	P_Gate Name	Description
Interlock Trip	IntlkTrip	None	Raised when an interlock 'not OK' condition occurs and the device is not in Position 1. The device can be configured to be commanded to Position 1 when an interlock trip occurs. If interlocks are not bypassed, a bypassable interlock or a non-bypassable interlock 'not OK' condition initiates an interlock trip. If interlocks are bypassed, only a non-bypassable interlock 'not OK' condition initiates an interlock trip.
I/O Fault	IOFault	None	Raised when the Inp_IOFault input is true. This input is usually used to indicate to the instruction that a communication failure has occurred for its I/O. If the I/O Fault is configured as a shed fault, the device will transition to the Faulted state and remain de-energized until reset.
Lock Fail	LockFail	None	Raised when a device with a locking or sealing feature is commanded to a new position, but the lock/seal feedback failed to confirm the device unlocking before moving or failed to confirm the device locking after moving, within the time allowed. If the Lock Failure is configured as a shed fault, the device will transition to the Faulted state and remain de-energized until reset.
Position Fail	PosFail	None	Raised when the device is commanded On, but the device feedback does not confirm that the device is actually On within the configured failure time (Cfg_OnFailT). If the Failure is configured as a shed fault, the device is commanded Off and cannot be commanded On until reset.

Parameters of the P_Alarm object can be accessed by using the following convention: [P_Alarm Name].[P_Alarm Parameter].

See Rockwell Automation Library of Process Objects: Common Alarm Block (P_Alarm) Reference Manual, publication [SYSLIB-RM002](#), for more information.

Simulation

Simulation in P_nPos disables the normal outputs and provides feedback of a working device. This lets you operate the n_Position Add-On Instruction as if it were a working device, even if no device is physically present.

You must set the Inp_Sim parameter in the controller to '1' to enable simulation.

The Simulation icon  is displayed at the bottom left of the Operator page indicating the device is in simulation.

You can also set the following parameters in simulation:

- Cfg_PosSimT - time to reach target position in simulation (seconds)
- Cfg_LockSimT - time to lock or unlock in simulation (seconds)
- Cfg_CylSimT - time to simulate index cylinder feedback in simulation (seconds)

When you have finished in simulation, set the Inp_Sim parameter in the controller to '0' to return to normal operation.

Execution

The following table explains the handling of instruction execution conditions.

Condition	Description
EnableIn False (false rung)	Handled the same as if the device were Disabled by Command. The device outputs are de-energized and the device is shown as Disabled on the HMI. The mode is shown as 'NO MODE'. All alarms are cleared.
Powerup (prescan, first scan)	On prescan, any commands received before first scan are discarded. The device is de-energized. On first scan, the device is treated as if it were returning from Hand mode: the instruction state is set based on the position feedback received from the device. If the feedback is valid for one position, the device is set to that position, and, if the device has the lock/seal capability enabled, the device is locked in that position. If the device does not have position feedback or the position feedback is invalid, the device is set to the 'unknown/powerup' state. Embedded P_Mode and P_Alarm Instructions are handled in accordance with their standard power-up procedures. See the Additional Resources table on page 5 for P_Mode and P_Alarm instructions, respectively.
Postscan	No SFC Postscan logic is provided.

See the Logix5000 Controllers Add-On Instructions Programming Manual, publication [1756-PM010](#), for more information.

Programming Example

This example uses the P_nPos instruction to control a rotating selector valve with four fixed positions. Each position directs a sample air from one of four sampling locations to an air quality monitor. The rotating selector valve directs all non-selected streams to flow to a common outlet to vent. In this example, the device handles transitions from one position to another. The instruction does not have to enforce a progression of positions to get to the desired state.

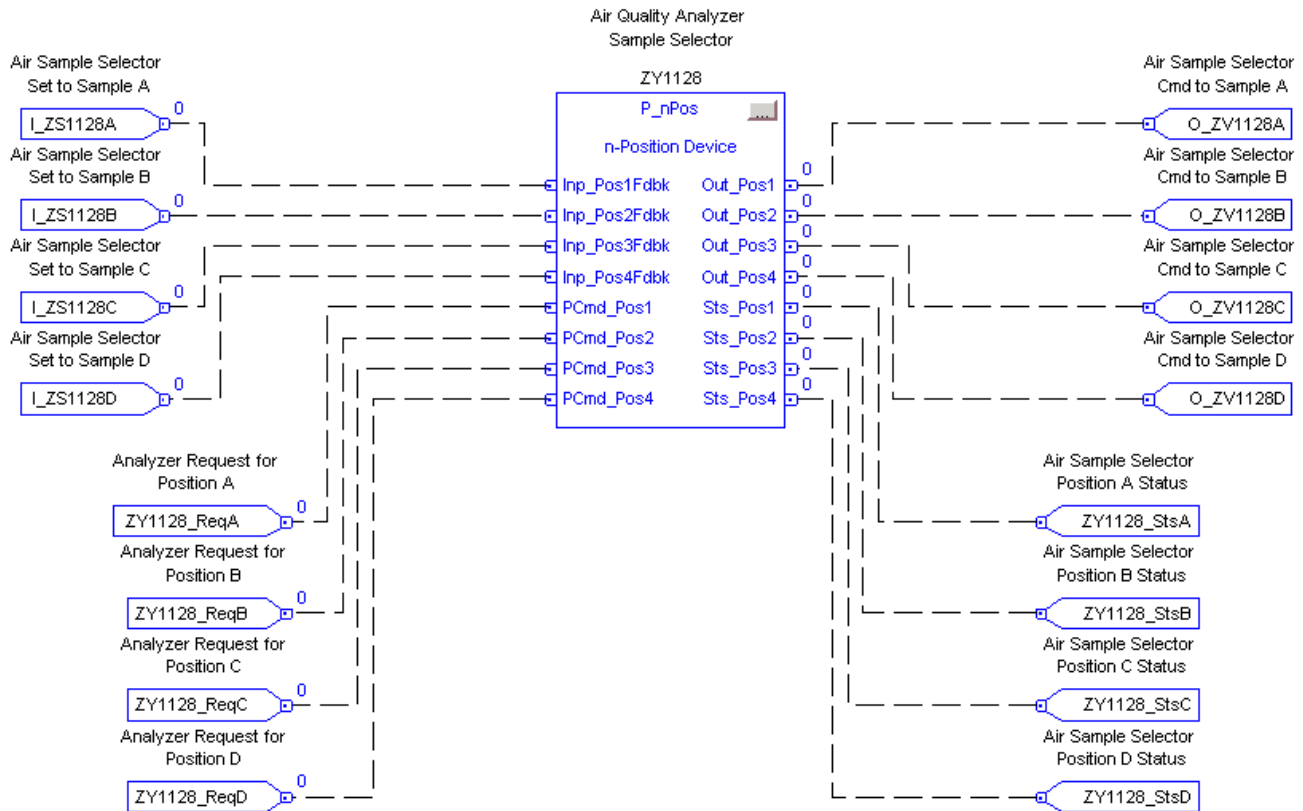

First, the instruction is configured to recognize the inputs coming from the selector valve. For this example, the parameter Cfg_NumPos is set to 4, indicating this is a four-position device. The parameter Cfg_HasPosFdbk and Cfg_UsePosFdbk are both set to 1 to indicate that the selector valve provides position feedback, and must be used. The input parameters for positions 1...4 (Inp_Pos1Fdbk, Inp_Pos2Fdbk, Inp_Pos3Fdbk, and Inp_Pos4Fdbk) are connected to the digital inputs representing the status of the selector valve.

Next, the instruction is configured to connect to the outputs of the instruction to the selector valve. The parameter Cfg_OutPosLatch is set to 1 to latch the output parameter until a new position is commanded. The output parameters for positions 1...4 (Out_Pos1, Out_Pos2, Out_Pos3, and Out_Pos4) are connected to the digital outputs that command the selector valve to the desired position.

Once the I/O has been configured, the instruction can be configured to recognize commands from the analyzer control sequence. In this example, the program command parameters for position (PCmd_Pos1, PCmd_Pos2, PCmd_Pos3, and PCmd_Pos4) are connected to the commands from the analyzer control sequence to command the selector valve to the desired position in the sequence. The parameter Cfg_ProgDefault is set to 1 to indicate that the normal operating state of the controller is Program, meaning it is normally commanded by the control sequence.

The valve does not have a locking or sealing device, so Cfg_HasLock is set to 0.

The parameter Cfg_HasPosFailAlm is set to 1 to indicate that an alarm is desired if the device is not at targeted position (additional settings for the alarm, such as severity and delay timers, are not covered in this example, but must be reviewed and set according to the plant alarm philosophy). Cfg_HasLockFailAlm, Cfg_HasIntlkTripAlm, and Cfg_HasIOFaultAlm are all set to 0, indicating that these alarms are not necessary for this device. The parameter Cfg_PosChkT is set to 30 seconds, to allow 30 seconds for the selector valve to achieve commanded position before a position failure alarm is issued.

The status output parameters (Sts_Pos1, Sts_Pos2, Sts_Pos3, and Sts_Pos4) can be connected to external tags to be used by the analyzer control sequence, if desired.

Lastly, the following local configuration tags must be configured to drive the text on the operations faceplate. In this example, the selector valve P&ID tag is ZY1128. In this example, the strings are set as follows:

Cfg_Tag:	ZY1128
Cfg_Label:	Air Sample Selector
Cfg_Desc:	Air Quality Analyzer Sample Selector
Cfg_Pos1Name:	Position A
Cfg_Pos2Name:	Position B
Cfg_Pos3Name:	Position C
Cfg_Pos4Name:	Position D

Display Elements

A display element (global object) is created once and can be referenced multiple times on multiple displays in an application. When changes are made to the original (base) object, the instantiated copies (reference objects) are automatically updated. Use of global objects, in conjunction with tag structures in the ControlLogix system, aid consistency and save engineering time.

Table 10 - P_nPos Display Elements Description











Display Element Name	Display Element	Description
GO_P_nPos_8SelValve		These display elements are used for routing one flow path to many vertically. These elements show all 3, 4, 6, or 8 ports and unused ports are not hidden.
GO_P_nPos_8SelValve1		
GO_P_nPos_6SelValve		
GO_P_nPos_6SelValve1		
GO_P_nPos_4SelValve		
GO_P_nPos_4SelValve1		
GO_P_nPos_3SelValve		
GO_P_nPos_3SelValve1		

Table 10 - P_nPos Display Elements Description

Display Element Name	Display Element	Description
GO_P_nPos_8PosRotary	 <p>The diagram shows a circular rotary selector with 8 positions labeled 1 through 8. A green 'P' icon is positioned above the selector, and a red 'X' icon is to its left. Below the selector is a horizontal bar with a red '!!' warning icon on the left and a yellow 'V' icon on the right. The text 'Power Up / Reset' is located to the right of the selector.</p>	<p>These display elements are used for rotary selection from one port to many ports. Only the ports enabled are displayed. For example, if you configure the P_nPos instruction with five positions, ports 6, 7, and 8 are not displayed.</p>
GO_P_nPos_6PosRotary	 <p>The diagram shows a circular rotary selector with 6 positions labeled 1 through 6. A green 'P' icon is positioned above the selector, and a red 'X' icon is to its left. Below the selector is a horizontal bar with a red '!!' warning icon on the left and a yellow 'V' icon on the right. The text 'Power Up / Reset' is located to the right of the selector.</p>	
GO_P_nPos_4PosRotary	 <p>The diagram shows a circular rotary selector with 4 positions labeled 1 through 4. A green 'P' icon is positioned above the selector, and a red 'X' icon is to its left. Below the selector is a horizontal bar with a red '!!' warning icon on the left and a yellow 'V' icon on the right. The text 'Power Up / Reset' is located to the right of the selector.</p>	
GO_P_nPos_SlideGate	 <p>The diagram shows a linear multi-position device represented as a slide gate. A green 'P' icon is positioned above the device, and a red 'X' icon is to its left. Below the device is a horizontal bar with a red '!!' warning icon on the left and a yellow 'V' icon on the right. The text 'Power Up / Reset' is located above the device.</p>	<p>These display elements show a linear multi-position device. The symbol is animated to show the position based on the number of positions configured.</p>
GO_P_nPos_SlideGate1	 <p>The diagram shows a linear multi-position device represented as a slide gate. A green 'P' icon is positioned above the device, and a red 'X' icon is to its left. Below the device is a horizontal bar with a red '!!' warning icon on the left and a yellow 'V' icon on the right. The text 'Power Up / Reset' is located above the device.</p>	
GO_P_nPos	 <p>The diagram shows a linear multi-position device with 8 positions labeled 1 through 8. A green 'P' icon is positioned above the device, and a red 'X' icon is to its left. Below the device is a horizontal bar with a red '!!' warning icon on the left and a yellow 'V' icon on the right. The text 'Power Up / Reset' is located above the device.</p>	<p>These display elements are similar to those shown on the first page of this table, but ports that aren't configured are not displayed.</p>
GO_P_nPos1	 <p>The diagram shows a linear multi-position device with 6 positions labeled 1 through 6. A green 'P' icon is positioned above the device, and a red 'X' icon is to its left. Below the device is a horizontal bar with a red '!!' warning icon on the left and a yellow 'V' icon on the right. The text 'Power Up / Reset' is located above the device.</p>	

Common attributes of the P_nPos global objects include the following:

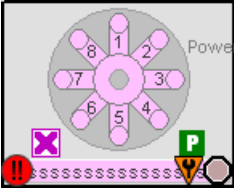
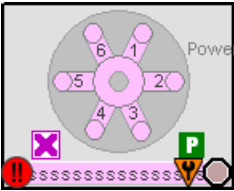
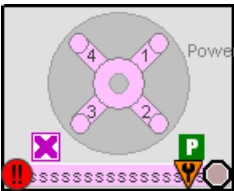
- Animated graphic symbol representing device
- State indication in text
- Mode indicator
- Status/Quality indicator
- Maintenance Bypass indicator
- Label
- Color changing alarm border that blinks on unacknowledged alarm
- Alarm indicator that changes color with the severity of an alarm

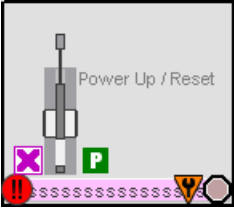
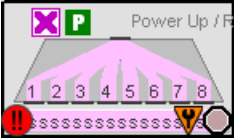
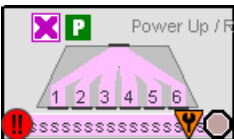
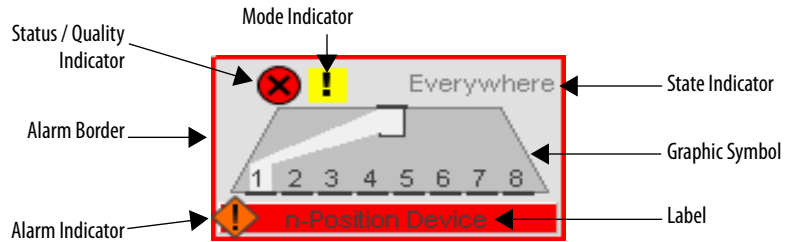

Each display element includes a touch field that accesses the object's faceplate. In addition, there is a tooltip that displays the object's configured tag and description.

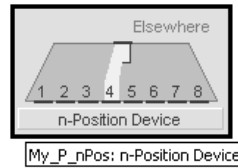

State Indicators







The state indicator text changes and the graphic symbol color changes depending on the state of the valve.

Color	State Text
Blue	Moving
White	In displayed position

Status/Quality Indicators

One of these symbols appears on the graphic symbol when the described condition is true.

Graphic Symbol	Description
	Invalid configuration.
	Data quality bad/failure.
	Data Quality degraded: uncertain, test, simulation, substitution, or out of specification.
	The input or device has been disabled.
	Device not ready to operate.

TIP When the Invalid Configuration Indicator appears, you can find what configuration setting is invalid by following the indicators. Click the graphic symbol to open the faceplate. The Invalid Configuration indicator appears next to the appropriate tab at the top of the faceplate to guide you in finding the configuration error. Once you navigate to the tab, the misconfigured item is flagged with this indicator or appear in a magenta box.

For the n-Position Device instruction, the Invalid Configuration indicator appears under the following conditions:

- The position check time or lock check time is set to a value less than zero or greater than 2,147,483 seconds.
- The feedback Simulation time is set to a value less than zero or greater than 2,147,483 seconds.
- Alarm Severity is set to a value less than 1 or greater than 1000.
- Number of positions greater than 8 or less than 2.

TIP When the Not Ready indicator appears, you can find what condition is preventing operation by following the indicators. Click the graphic symbol to open the faceplate. The Not Ready indicator appears next to the appropriate tab at the top of the faceplate to guide you in finding the condition. When you navigate to the tab, the condition preventing operation is flagged.









For the n-Position Device instruction, the Device Not Ready indicator appears under the following conditions:

- Device has been disabled by Maintenance.
- There is a configuration error.
- Interlock or Permissive is not OK.
- Operator State 0 priority command requires reset.
- Device Failure and Shed requires reset.
- I/O Fault and Shed requires reset.

Device logic is disabled or there is no mode.

Mode Indicators

One of these symbols appears on the right side of the graphic symbol to indicate the mode of the object instruction.







Graphic Symbol	Description
Transparent	Operator mode (if the default mode is Operator and the current mode is Operator, the mode indicator is transparent).
	Operator mode (if the default mode is Program).
	Operator mode locked.
Transparent	Program mode (if the default mode is Program and the current mode is Program, the mode indicator is transparent).
	Program mode (if the default mode is Operator).
	Program mode locked.
	Override mode
	Maintenance mode.
	Hand mode
	No mode.

TIP The images provided for the Operator and Program default modes are transparent; therefore, no mode indicators are visible if the device is in its default mode. This behavior can be changed by replacing the image files for these mode indicators with images that are not transparent.

See Rockwell Automation Library of Process Objects: Common Mode Block (P_Mode) Reference Manual, publication [SYSLIB-RM005](#), for more information.

Alarm Indicators

One of these symbols appears on the left side of the label to indicate the described alarm condition and the alarm border and label background change color. The alarm border and label background blink if acknowledgement of an alarm condition is required. Once the alarm is acknowledged, the alarm border and label background remain the color that corresponds to the severity of the alarm.

Symbol	Border and Label Background	Description
	No change in color	Alarm Inhibit: an alarm is suppressed by the Program, disabled by Maintenance, or shelved by the Operator.
	White	Return to normal (no alarm condition), but a previous alarm has not been acknowledged.
	Blue	Low severity alarm.
	Yellow	Medium severity alarm.
	Red	High severity alarm.
	Magenta	Urgent severity alarm.
No symbol	No change in color	No alarm or alarm inhibit condition, and all alarms are acknowledged.

See Rockwell Automation Library of Process Objects: Common Alarm Block (P_Alarm) Reference Manual, publication [SYSLIB-RM002](#), for more information.

Maintenance Bypass Indicator

This symbol appears to the right of the label to indicate that a maintenance bypass has been activated.

TIP When the Maintenance Bypass Indicator appears, you can find what condition was bypassed by following the indicators. Click the graphic symbol to open the faceplate. The Maintenance Bypass Indicator appears next to the appropriate tab at the top of the faceplate to guide you in finding the bypass. Once you navigate to the tab, the bypassed item is flagged with this indicator.

For the n-Position Device instruction, the Maintenance Bypass indicator appears for the following conditions:

- Bypassable Interlocks and Permissives have been bypassed.
- The device is configured to have a position or lock feedback, but the feedback is not being used.

Using Display Elements

The global objects for P_nPos can be found in the global object file (RA-BAS) P_nPos Graphics Library.ggfx. Complete the following steps to use a global object.

1. Copy it from the global object file and paste it in the display file.

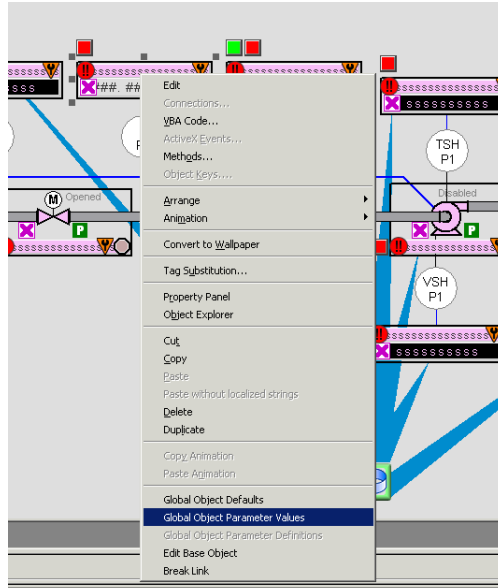

2. In the display, right-click the global object and choose Global Object Parameter Values.

The Global Object Parameter Values dialog box appears.

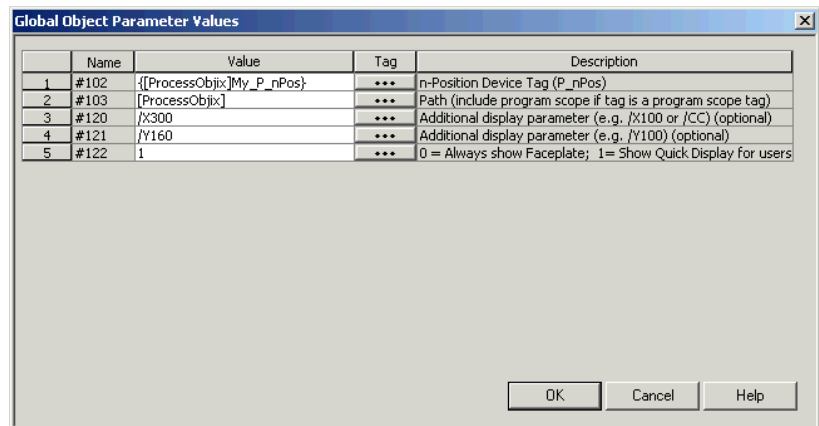

The global object parameters are as follows.

Parameter	Required	Description
#102	Y	Object tag to point to the name of the associated object Add-On Instruction in the controller.
#103	Y	Path used for display navigation features to other objects. Include program scope if tag is a program scope tag.
#120	N	Additional parameter to pass to the display command to open the faceplate. Typically used to define position for the faceplate.
#121	N	Additional parameter to pass to the display command to open the faceplate. If defining X and Y coordinate, separate parameters so that X is defined by #120 and Y is defined by #121. This lets the same parameters be used in subsequent display commands originating from the faceplate.
#122	Y	These are the options for the global object display: 0 = Always show faceplate 1 = Show Quick Display for users without Maintenance access (Code C) 2 = Always show Quick Display

3. Type the tag or value in the Value column as specified in the Description column.

TIP You can click the ellipsis (. . .) to browse and select a tag.
Values for items marked '(optional)' can be left blank.

4. Click OK.

Quick Display

The Quick Display screen provides a means for operators to perform simple interactions with the P_nPos instruction instance. From the Quick Display, you can navigate to the faceplate for full access for operation, maintenance, and configuration.

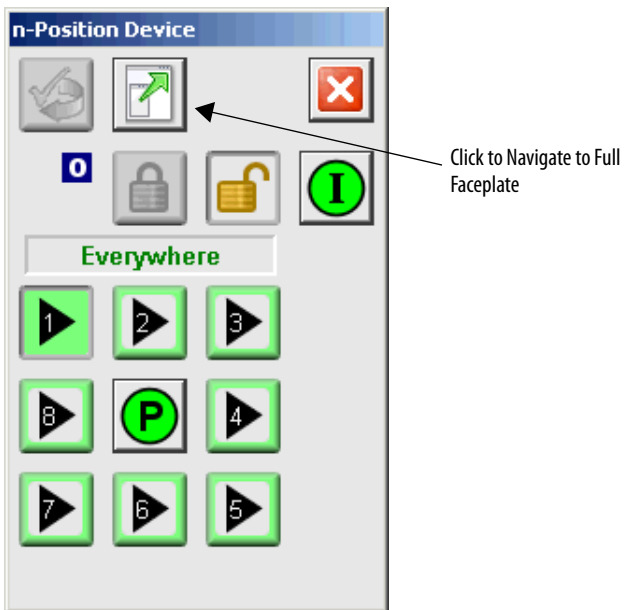

Faceplate

The P_nPos faceplate consists of five tabs and each tab consists of one or more pages.

The title bar of the faceplate contains the value of local configuration tags Cfg_Tag and Cfg_Desc.

Tag - Description

The Operator tab is displayed when the faceplate is initially opened. Click the appropriate icon at the top of the faceplate to access a specific tab.

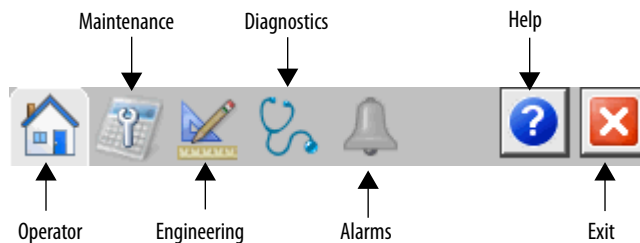

The faceplate provides the means for operators, maintenance personnel, engineers, and others to interact with the P_nPos instruction instance, including viewing its status and values and manipulating it through its commands and settings. When a given input is restricted via FactoryTalk View security, the required user security code letter is shown in the tables that follow.

Operator Tab

The Faceplate initially opens to the Operator ('Home') tab. From here, an operator can monitor the device status and manually operate the device when it is in Operator mode.





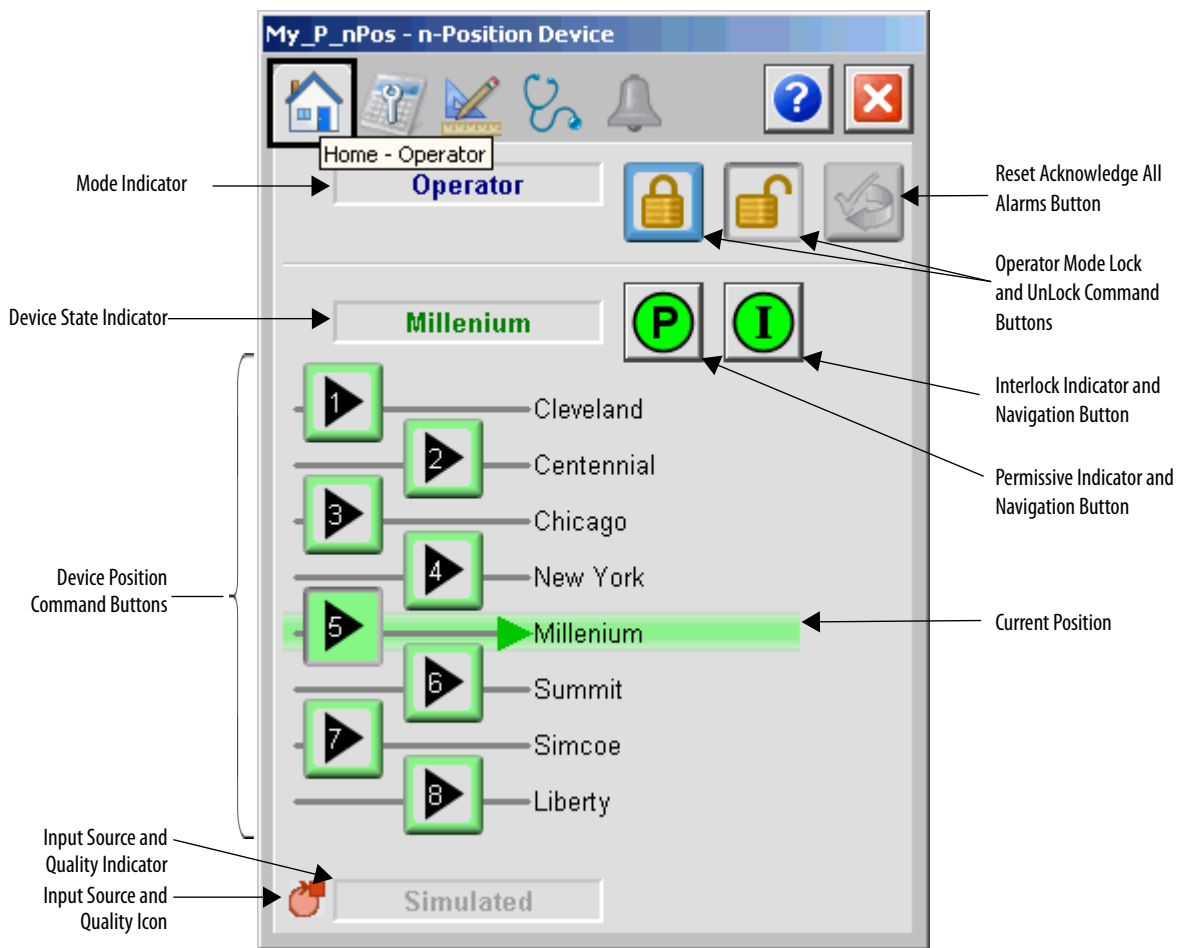



The Operator tab shows the following information:

- Current mode (Operator, Program, Override, Maintenance, or Hand)
- Requested Modes Indicator (Appears only if the Operator or Program mode has been superseded by another mode)
- n-Position Device State (In Position, Unlocking, Move to Pos. 1, Moving, Locking, or Faulted)
- Position Fault or Lock Fault (Appears under the Device State when the fault is active)
- Interlock and Permissive States
- Input Source and Quality indicator (See 'SrcQ' in the Output parameters table on [page 19](#) for details).



The following table shows the functions included on the Operator tab.









Table 11 - Operator Tab Description

Function	Action	Security
	Click to release Operator mode lock.	Manual Device Operation (Code B)
	Click to lock in Operator mode.	Manual Device Operation (Code B)
	Click to request Program mode.	Manual Device Operation (Code B)
	Click to request Operator mode.	
	Click to reset and acknowledge all alarms.	Acknowledge Alarms (Code F)
	Click to open the Permissive faceplate. The Permissive status symbol becomes a button that opens the Permissive faceplate if the P_nPos instruction is configured to have an associated P_Perm Instruction.	None
	Click to open the Interlock faceplate. The Interlock status symbol becomes a button that opens the Interlock faceplate if the P_nPos instruction is configured to have an associated P_Intlk Instruction.	
	Click the Device State button to command to that position (1...8).	Normal Operation of Devices (Code A)

If the object is configured to have permissive and interlock objects (for example, Cfg_HasIntlkObj is true), the permissive and interlock indication become buttons that open the faceplates of the source objects used as a permissive or interlock (often this is a P_Intlk interlock or a P_Perm permissive object). If the object is not configured in this way, the permissive or interlock are indicators only.

For more information, see Rockwell Automation Library of Process Objects: Permissives with Bypass (P_Perm) Reference Manual, publication [SYSLIB-RM007](#) and Rockwell Automation Library of Process Objects: Interlocks with First Out and Bypass (P_Intlk) Reference Manual, publication [SYSLIB-RM004](#).

One of these symbols appears to indicate the described Interlock or Permissive condition.





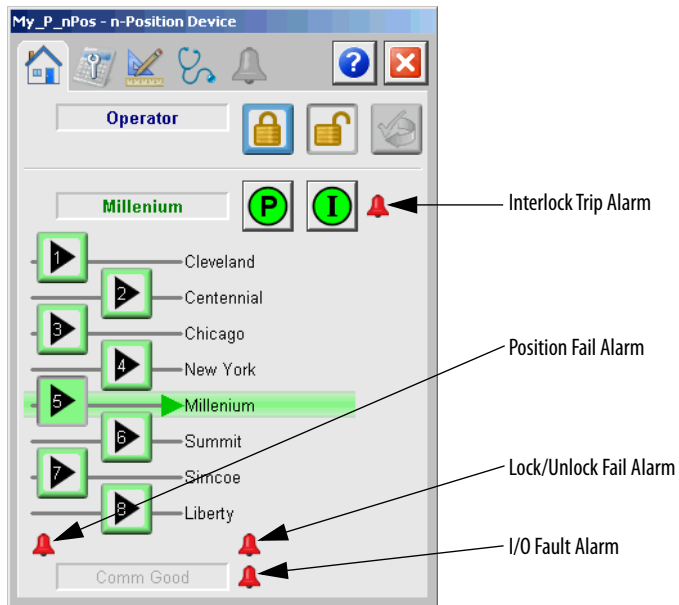

Permissive Symbol	Interlock Symbol	Description
		One or more conditions not OK
		Non-bypassed conditions OK
		All conditions OK, bypass active
		All conditions OK

Alarm indicators appear on the Operator tab when the corresponding alarm occurs.



The following table shows the alarm status on the Operator tab.

Table 12 - Operator Tab Alarm Status

Graphic Symbol	Alarm Status
	In alarm (active alarm)
	In alarm and acknowledged
	Out of alarm but not acknowledged
	Alarm suppressed (by Operator; alarm is logged but not displayed)
	Alarm disabled (by Maintenance)
	Alarm Shelved (by Operator)

Maintenance Tab

Maintenance personnel use the information and controls on the Maintenance tab to adjust device parameters, troubleshoot and temporarily work around device problems, and disable the device for routine maintenance.

The Maintenance tab is divided into three tabs.

Maintenance Tab Page 1





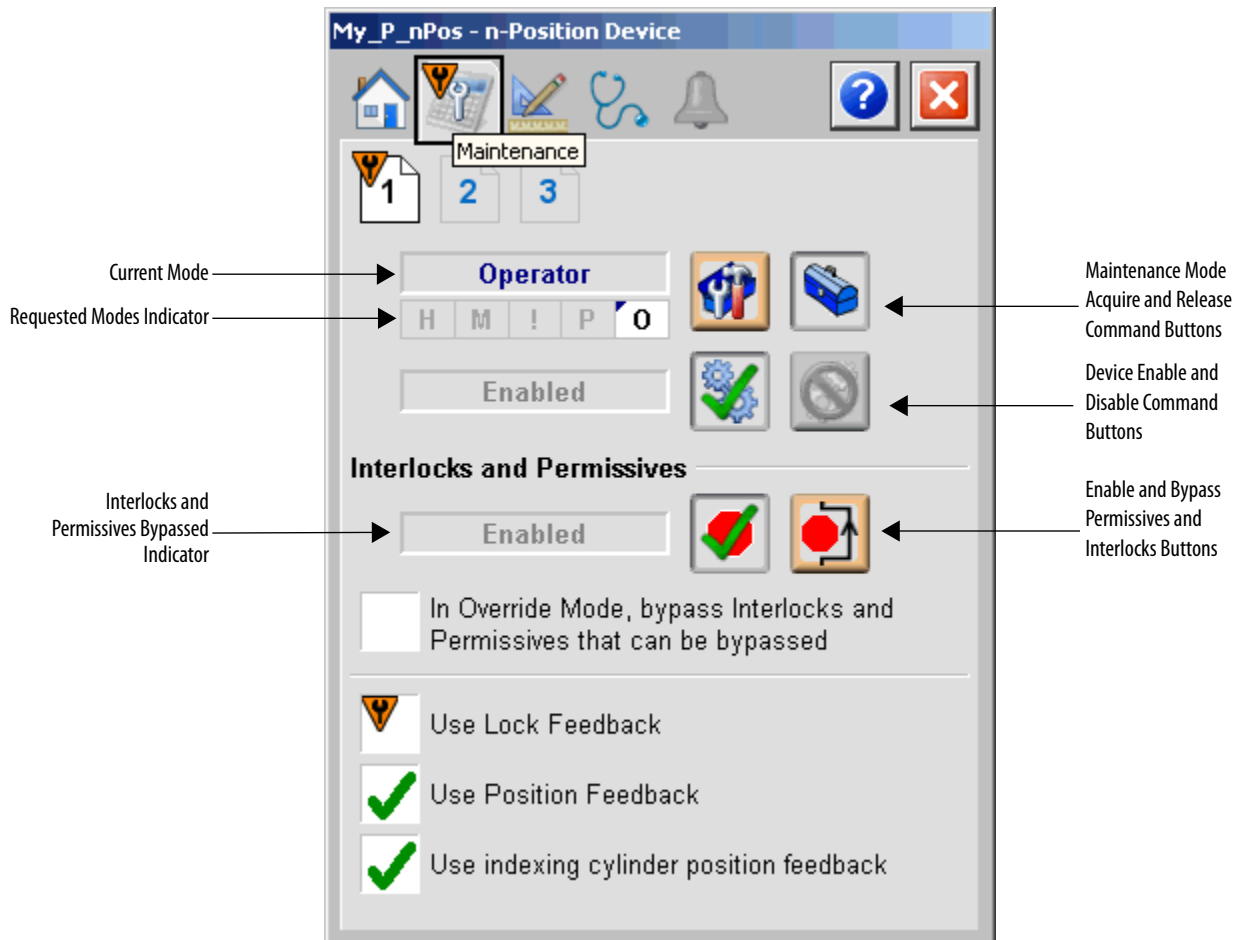

Page 1 of the Maintenance tab shows the following information:

- Current mode (Operator, Program, Override, and Hand, Maintenance)
- Requested Modes Indicator - This display highlights all modes that have been requested. The leftmost highlighted mode is the active mode
- Whether n-Position Device is enabled or disabled
- Permissive Bypassed/Enabled Indicator
- Whether Override mode bypasses the bypassable permissives
- Whether the device's position, lock, and cylinder feedbacks are checked when operating the device
- Position feedback, Lock feedback, and Cylinder Position feedback



The following table shows the functions on the Maintenance tab page1.

Table 13 - Maintenance Tab Page 1 Description

Function	Action	Security	Configuration Parameters
	Click to place device in Maintenance mode.	Equipment Maintenance (Code C)	None
	Click to release device from Maintenance mode.		
	Click to enable device.		
	Click to disable device.		
	Click to enable checking of all permissives and interlocks.	Disable Alarms Bypass Permissives and Interlocks (Code H)	
	Click to bypass checking of bypassable permissives and interlocks.		
In Override Mode, bypass Interlocks and Permissives that can be bypassed	Check to bypass interlocks and permissives in Override mode.		
Use Lock Feedback	Check to have the instruction verify locking and unlocking.	Equipment Maintenance (Code C)	Cfg_UseLockFdbk
Use Position Feedback	Check to have the instruction use the Position Feedback to check the position of the device.		Cfg_UsePosFdbk
Use indexing cylinder position feedback	Check to have the instruction use the index cylinder position feedback.		Cfg_UseCylFdbk

Maintenance Tab Page 2

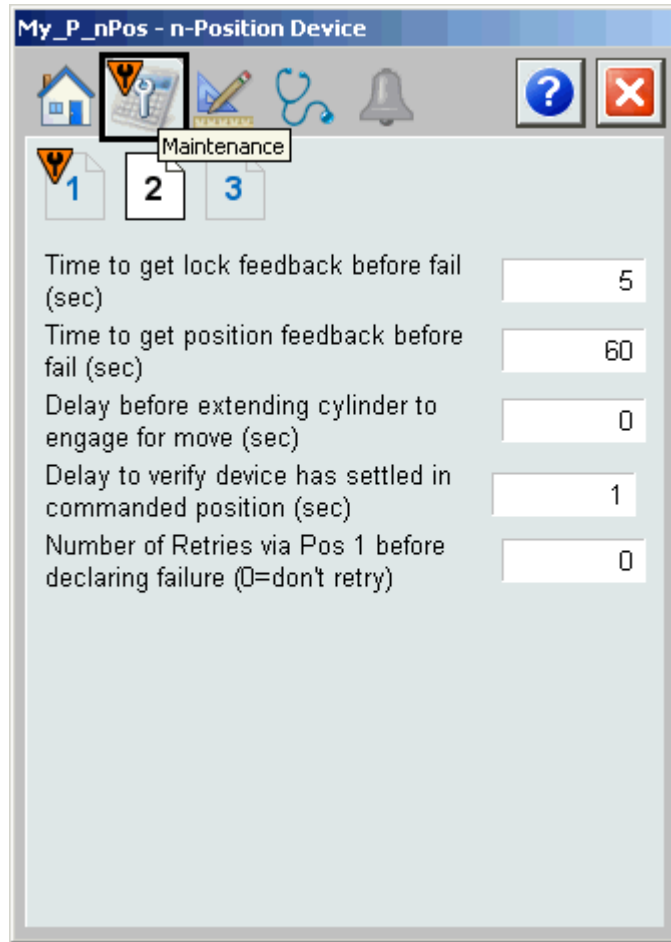

The following table shows the functions on page 2 of the Maintenance tab.

Table 14 - Maintenance Tab Page2 Description

Function	Action	Security	Configuration Parameters
Time to get lock feedback before fail (seconds)	Type a value (0...2,147,483) that indicates the maximum time allowed for lock feedback before a fail.	Configuration & Tuning Maintenance (Code D)	Cfg_LockChkT
Time to get position feedback before fail (seconds)	Type a value (0...2,147,483) that indicates the maximum time allowed for the device to be in position before a fail.		Cfg_PosChkT
Delay before extending cylinder to engage for move (seconds)	Type a value (0...2,147,483) that indicates the time delay before engaging a cylinder move.		Cfg_ExtendT
Delay to verify device has settled in commanded position (seconds)	Type a value (0...2,147,483) that indicates the delay time to verify a device is in a commanded position.		Cfg_VerifyT
Number of Retries via Pos 1 before declaring failure (0=don't retry)	Type a value (0...2,147,483) to indicate the number of retries for a device in Position 1 before a fault is set.		Cfg_Retries

Maintenance Tab Page 3

This tab shows the state of the instruction sequence for moving the n-position device. The current state is highlighted.

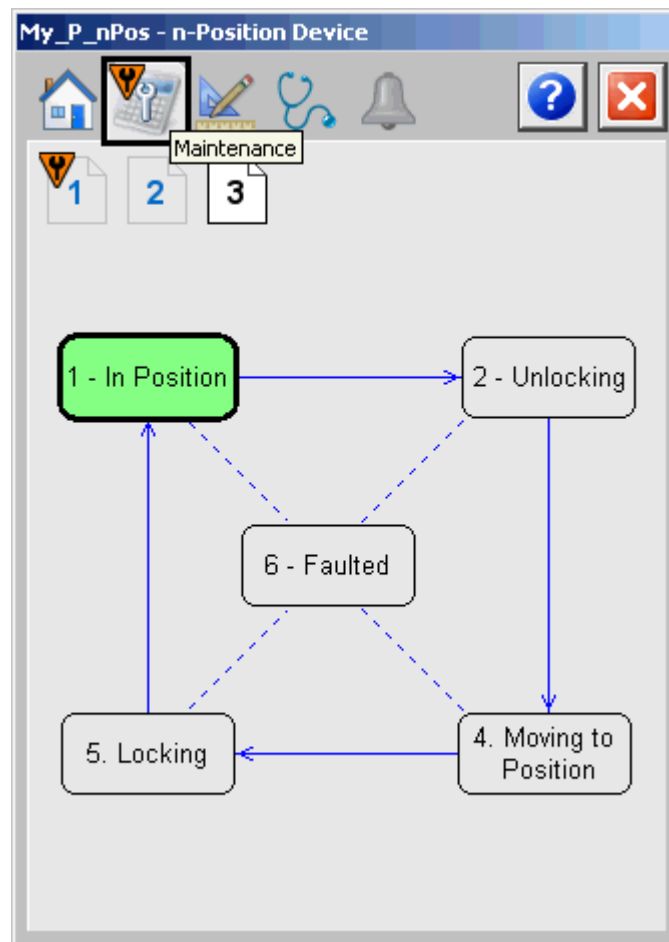

State	Position	Description
1	In Position	This state is highlighted whenever the device is in the position that it was last commanded.
2	Unlocking	This state is displayed only if the device is configured with a lock or seal that must be unlocked or unsealed to move. This state is highlighted when the device has been commanded to unlock, but unlocked feedback has not been received yet.
3	Moving to Pos 1	This state is displayed only if the device is configured as a linear device that returns to position 1 on every move. This is done to approach each position from the same side. This state is highlighted when the device has been unlocked and is being moved to position 1, but position 1 feedback has not been received yet.
4	Moving to Position	This state is highlighted when the device is being moved to its commanded position, but that position feedback has not been received yet.
5	Locking	This state is displayed only if the device is configured with a lock or seal that must be unlocked or unsealed to move. This state is highlighted when the device has reached its commanded position and has been commanded to lock, but locked feedback has not been received yet.
6	Faulted	This state is highlighted if the device feedback fails to confirm that the device unlocked, moved to position, or locked as requested within the configured failure times.

Engineering Tab

The Engineering tab provides access to device configuration parameters and ranges, options for device and I/O setup, displayed text, and faceplate-to-faceplate navigation settings, and for initial system commissioning or later system changes.

The Engineering tab is divided into four pages.

Engineering Tab Page 1

On Page 1 of the Engineering tab, you can describe and define device characteristics.

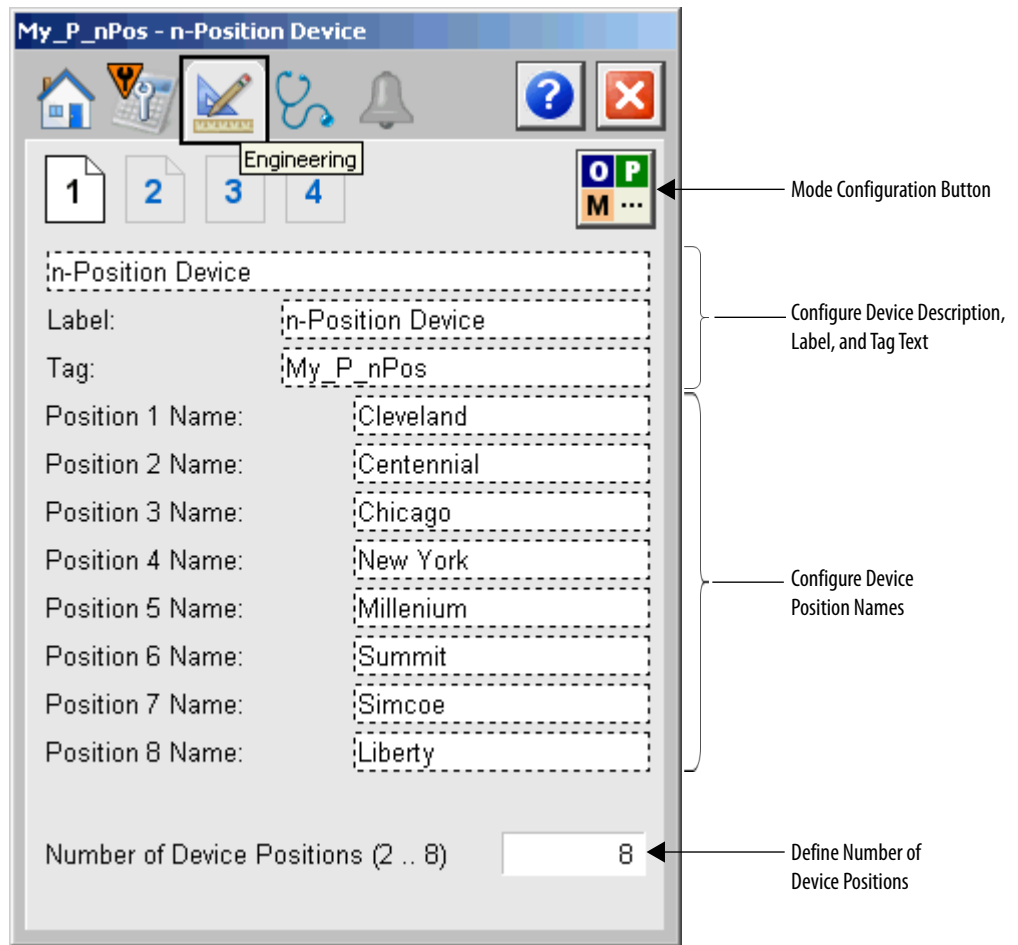

The following table lists the functions on the Engineering tab page 1.

Table 15 - Engineering Tab Page 1 Description

Function	Action	Security	Configuration Parameters
	Click to navigate to the Mode Configuration display.	None	See Mode Configuration display on page 49
Description	Type the device description to show on the faceplate title bar.	Engineering Configuration (Code E)	Cfg_Desc
Label	Type the label to show on the graphic symbol.		Cfg_Label
Tag	Type the tag name to show on the faceplate title bar and in the tooltip. TIP: Pausing the mouse over this field displays a tool tip with the configured Logix tag/path.		Cfg_Tag
Position 1...8 Name	Type a name for each device position based on the number of positions.		<ul style="list-style-type: none"> • Cfg_Pos1Name • Cfg_Pos2Name • Cfg_Pos3Name • Cfg_Pos4Name • Cfg_Pos5Name • Cfg_Pos6Name • Cfg_Pos7Name • Cfg_Pos8Name
Number of Device Positions (2...8)	Type the number of device positions.		Cfg_NumPos

Mode Configuration Display

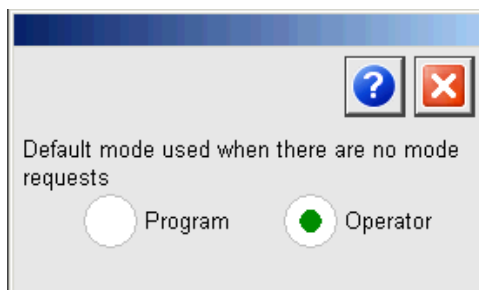

This display lets you select the default mode for the object by selecting the appropriate mode.

IMPORTANT If no mode is being requested, changing the default mode changes the mode of the instruction.

You must have FactoryTalk View security code E to select the default mode on this display.

Engineering Tab Page 2

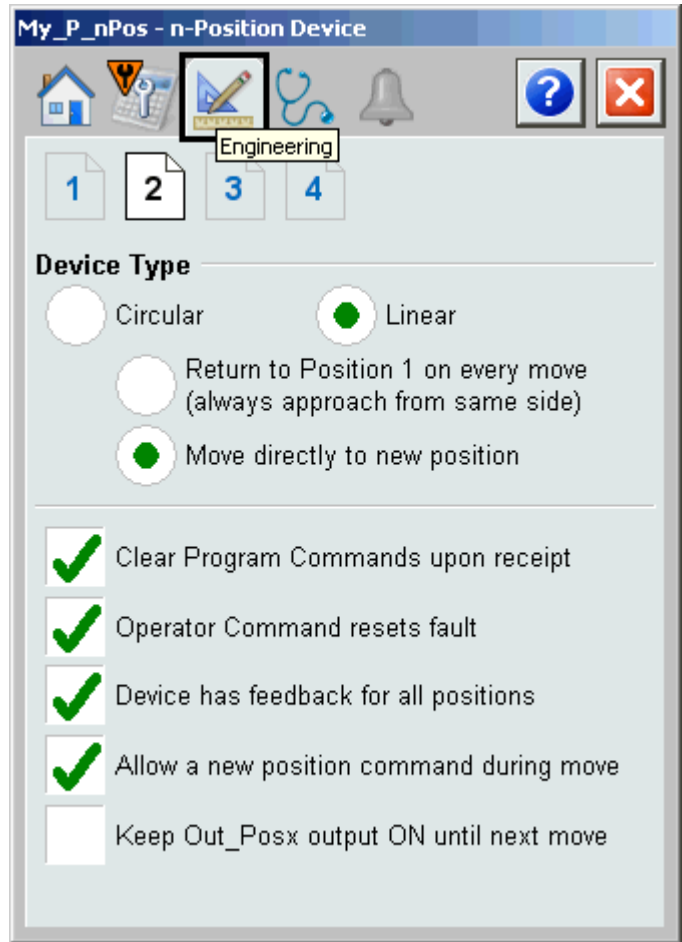

The following table lists the functions on page 2 of the Engineering tab.

Table 16 - Engineering Tab Page 2 Description

Function	Action	Security	Configuration Parameters
Device Type Circular Linear	Click circular or linear for the device type.	Engineering Configuration (Code E)	Cfg_Circ
Circular: CW only (moves only in direction of increasing position number) CW or CCW (moves either direction)	For Circular, click either clockwise only or clockwise or counterclockwise.		Cfg_CWonly
Linear: Return to Position 1 on every move (always approach from same side) Move directly to new position	For Linear, click whether the device returns to Position 1 for every move or moves directly to the target position.		Cfg_ViaPos1

Table 16 - Engineering Tab Page 2 Description

Function	Action	Security	Configuration Parameters
Clear Program Commands on receipt	Check to enable the clearing of program commands on receipt.	Engineering Configuration (Code E)	Cfg_PCmdClear
New Operator position command resets fault	Check to enable a new operator position command to reset a fault.		Cfg_OCmdResets
Device has feedback for all positions	Check to enable device feedback for all positions.		Cfg_HasPosFdbk
Allow a new position command during move	Check to enable a new position command to be received and processed while a move is in progress.		Cfg_CmdDuringMove
Keep Out_Posx output ON until next move.	Check to keep a position output On until the next move.		Cfg_OutPosLatch

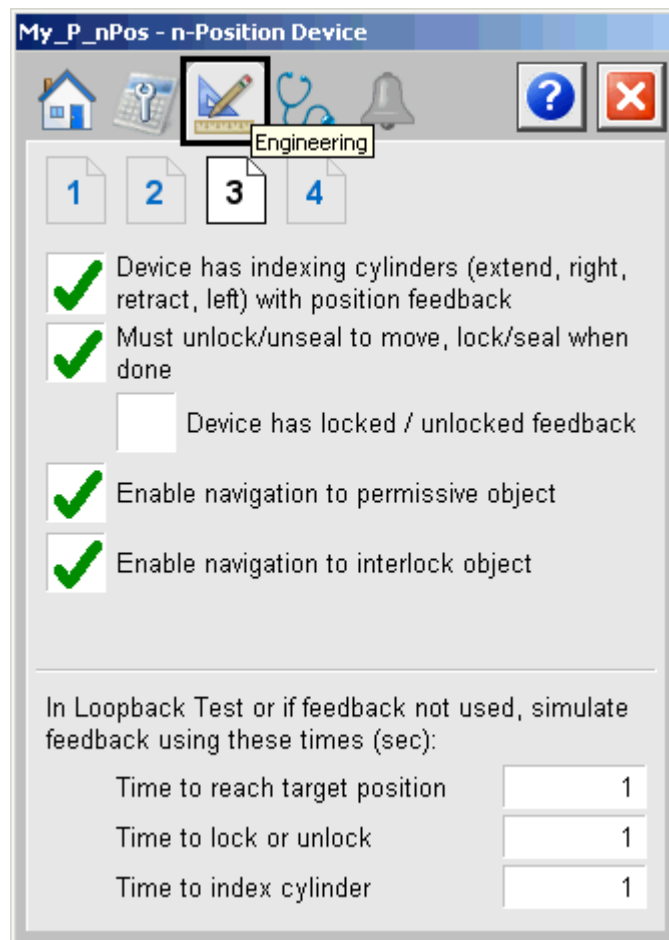
Engineering Tab Page 3

My_P_nPos - n-Position Device

Engineering

1 2 3 4

Device has indexing cylinders (extend, right, retract, left) with position feedback

Must unlock/unseal to move, lock/seal when done

Device has locked / unlocked feedback

Enable navigation to permissive object

Enable navigation to interlock object

In Loopback Test or if feedback not used, simulate feedback using these times (sec):

Time to reach target position

Time to lock or unlock

Time to index cylinder

The following table lists the functions on page 3 of the Engineering tab.

Table 17 - Engineering Tab Page 3 Description

Function	Action	Security	Configuration Parameters
Device has indexing cylinders (extend, right, retract, left) that have position feedback	Check to enable indexing cylinders with position feedback.	Engineering Configuration (Code E)	Cfg_HasCylFdbk
Must unlock/unseal to move, lock/seal when done	Check if the device must be unlocked to move and locked when the move is complete.		Cfg_HasLock
Device has locked/unlocked feedback	Check if the device has feedback for locked/unlocked positions.		Cfg_HasLockFdbk
Enable navigation to permissive object	Check to indicate that a permissive object is connected to this object's permissive inputs. IMPORTANT: The name of the Permissives object in the controller must be this object's name with the suffix '_Perm'. For example, if your P_nPos object has the name 'nPos123', then its Permissives object must be named 'nPos123_Perm'.		Cfg_HasPermObj
Enable navigation to interlock object	Check to indicate that an interlock object is connected to this object's interlock inputs. IMPORTANT: The name of the Interlock object in the controller must be this object's name with the suffix '_Intlk'. For example, if your P_nPos object has the name 'nPos123', then its Interlock object must be named 'nPos123_Intlk'.		Cfg_HasIntlkObj
In Loopback Test or if feedback not used, simulate feedback using these times (seconds): Time to reach target position	Type the time (0...2,147,483) to reach a target position in simulation.		Cfg_PosSimT
In Loopback Test or if feedback not used, simulate feedback using these times (seconds): Time to lock or unlock	Type the time (0...2,147,483) to lock/unlock with the device in simulation.		Cfg_LockSimT
In Loopback Test or if feedback not used, simulate feedback using these times (seconds): Time to index cylinder	Type the time (0...2,147,483) to simulate index cylinder feedback in simulation.		Cfg_CylSimT

Engineering Tab Page 4

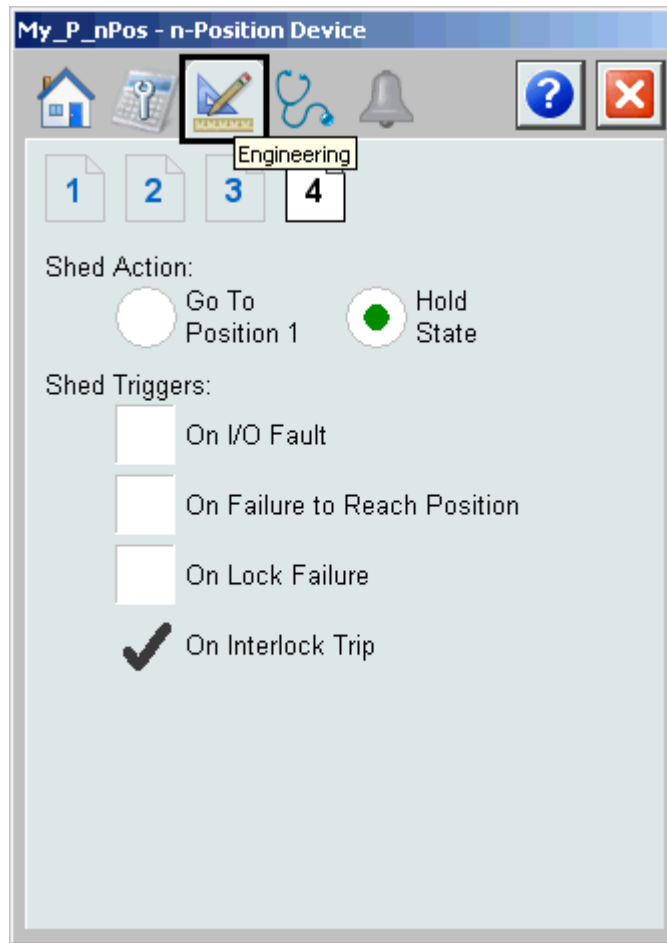

The following table lists the functions on page 4 of the Engineering tab.

Table 18 - Engineering Tab Page 4 Description

Function	Action	Security	Configuration Parameters
Shed Action: Go In Position 1 Hold State	Click to determine whether the device holds the hold position or goes to position 1 upon a shed condition.	Engineering Configuration (Code E)	Cfg_IntlktoPos1
Shed Triggers	Check to enable whether an I/O Fault, Failure to Reach Position, or Lock Failure is considered a shed condition. The device always sheds on an Interlock Trip. This item cannot be unchecked. It is displayed as a reminder that the Interlock Trip function always triggers a shed. If a condition causes the device to shed, a reset is required to operate the device.		<ul style="list-style-type: none"> • Cfg_ShedOnFault • Cfg_ShedOnPosFail • Cfg_ShedOnLockFail

Diagnostics Tab

The Diagnostic tab provides indications helpful in diagnosing or preventing device problems, which can include specific reasons a device is 'Not Ready', device warnings and faults, warning and fault history, and predictive/preventive maintenance data.

The Diagnostics tab displays possible reasons the device is not ready.

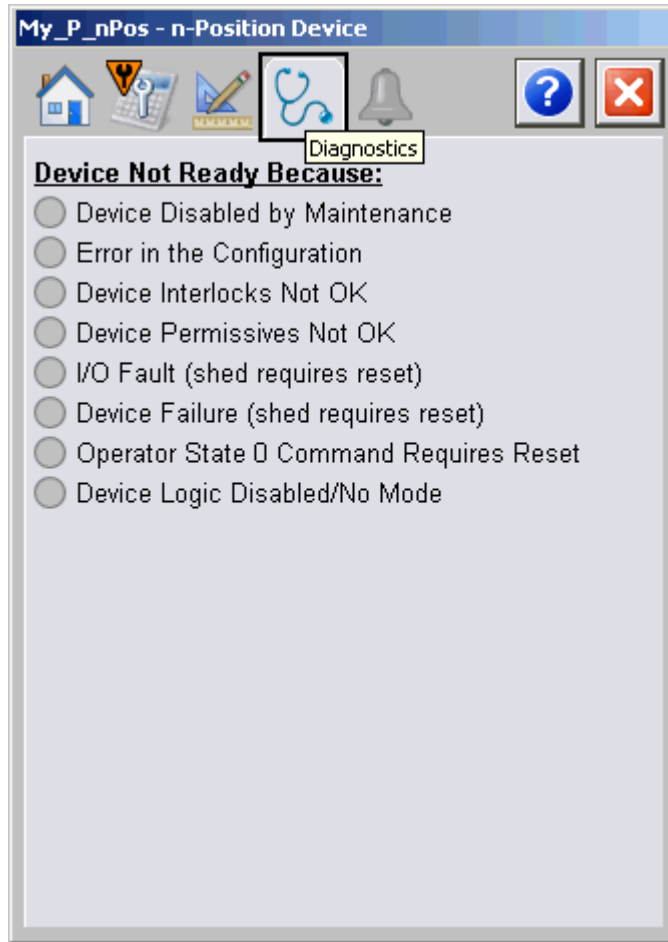

Alarms Tab

The Alarms tab displays each configured alarm for the P_nPos instruction. The icon on the tab for the Alarms page changes color based on the current active alarms. A blinking alarm icon indicates that one or more alarms must be acknowledged or the device must be reset.

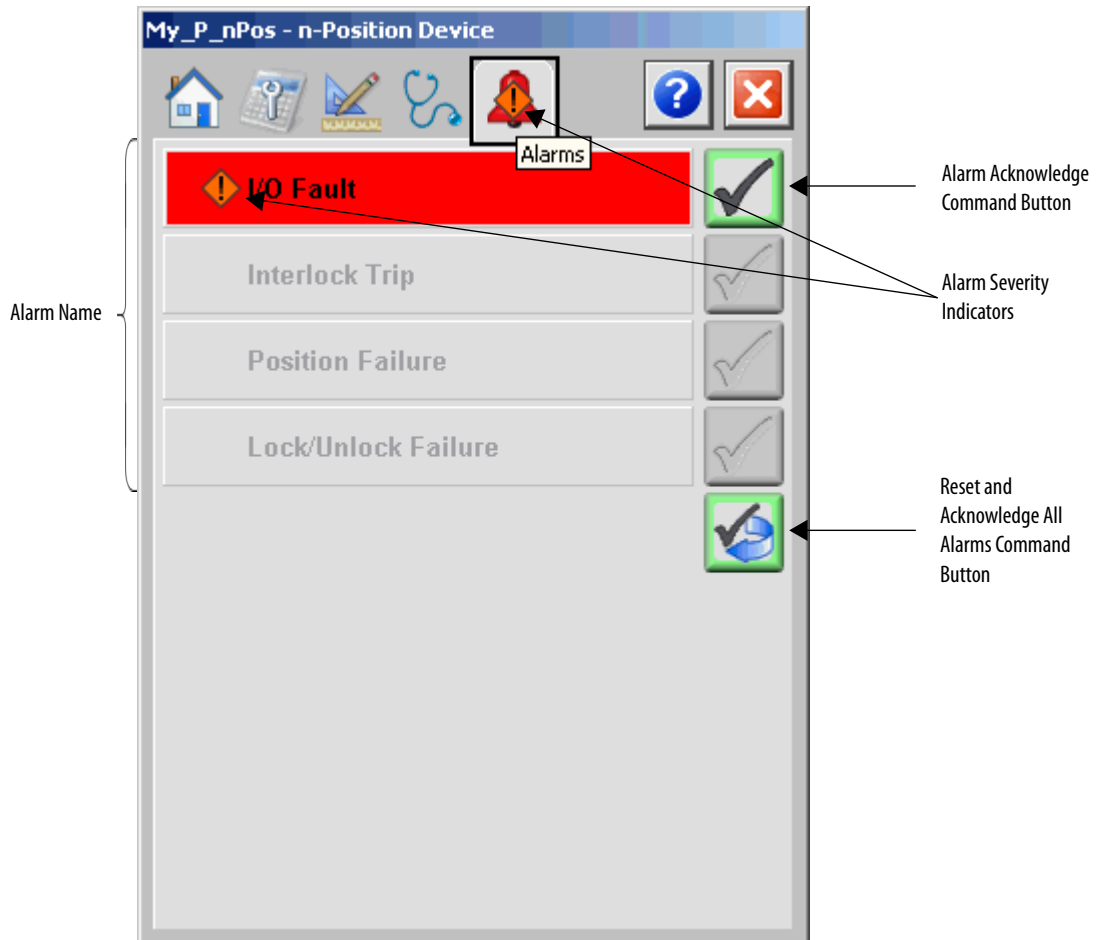

Click an alarm name to open the P_Alarm faceplate for that alarm. From the P_Alarm faceplate, you can configure and perform additional operations on the alarm.



If an alarm is active, the panel behind the alarm changes color to match the severity of the alarm. The color of the bell icon at the top of the faceplate shows the severity of the highest active alarm, and the icon blinks if any alarm is unacknowledged or requires reset.

Table 19 - Alarm Severity Colors

Color	Definition
Magenta	Urgent
Red	High
Yellow	Medium
Blue	Low
White (bell icon)	Alarm has cleared but is unacknowledged
Background (Light Gray)	No alarm

The following table shows the functions on the Alarms tab.

Table 20 - Alarms Tab Description

Function	Action	Security
Alarm Name	Click an alarm name to open the associated P_Alarm faceplate.	None
	Click to acknowledge the alarm.	Acknowledge Alarms (Code F)
	Click to reset and acknowledge all alarms.	

When the Reset and Acknowledge All Alarms button is enabled, the panel behind the alarm blinks, indicating the alarm requires acknowledgement or reset. The Alarm Acknowledge button is enabled if the alarm requires acknowledgement. Click the button with the check mark to acknowledge the alarm.

See Rockwell Automation Library of Process Objects: Common Alarm Block (P_Alarm) Reference Manual, publication [SYSLIB-RM002](#), for more information.

n-Position Device Faceplate Help

Faceplate Help Page 1

n-Position Device Faceplate Help

1 2

Status Indicators

- Invalid Configuration
- Communication Failure
- Communication Uncertain
- Device Not Ready To Operate
- Alarm Inhibit (Suppressed or Disabled)
- Maintenance Bypass Active
- Device in Simulation or Test
- Device Disabled

Mode Indicators

- Device in Program Mode
- Device in Maintenance Mode
- Override
- Device in Operator Mode
- No Mode (Out of Service)
- Hand (Local)

Interlocks and Permissives

- One or more conditions not OK
- Non-Bypassed conditions OK
- All conditions OK, Bypass Active
- All conditions OK
- Enable checking all Interlock and Permissive conditions
- Bypass Interlocks and Permissives that can be bypassed

Faceplate Help Page 2

n-Position Device Faceplate Help

1 2

Commands

- Move to Position.
Available in Operator or Maintenance Mode

Alarms

Position Failure Alarm
The Position Failure Alarm occurs when device fails to reach the commanded position within the specified time period.

Lock Failure Alarm
The Lock Failure Alarm occurs when the device fails to Lock or Unlock within the specified time period

I/O Fault Alarm
The I/O Fault Alarm is triggered when a controller hardware or communication fault is detected.

Interlock Trip Alarm
The Interlock Trip Alarm is triggered when an interlock condition causes the valve to return to its fail safe state.

Notes:

Rockwell Automation Support

Rockwell Automation provides technical information on the Web to assist you in using its products.

At <http://www.rockwellautomation.com/support> you can find technical and application notes, sample code, and links to software service packs. You can also visit our Support Center at <https://rockwellautomation.custhelp.com/> for software updates, support chats and forums, technical information, FAQs, and to sign up for product notification updates.

In addition, we offer multiple support programs for installation, configuration, and troubleshooting. For more information, contact your local distributor or Rockwell Automation representative, or visit <http://www.rockwellautomation.com/services/online-phone>.

Installation Assistance

If you experience a problem within the first 24 hours of installation, review the information that is contained in this manual. You can contact Customer Support for initial help in getting your product up and running.

United States or Canada	1.440.646.3434
Outside United States or Canada	Use the Worldwide Locator at http://www.rockwellautomation.com/rockwellautomation/support/overview.page , or contact your local Rockwell Automation representative.

New Product Satisfaction Return

Rockwell Automation tests all of its products to help ensure that they are fully operational when shipped from the manufacturing facility. However, if your product is not functioning and needs to be returned, follow these procedures.

United States	Contact your distributor. You must provide a Customer Support case number (call the phone number above to obtain one) to your distributor to complete the return process.
Outside United States	Please contact your local Rockwell Automation representative for the return procedure.

Documentation Feedback

Your comments will help us serve your documentation needs better. If you have any suggestions on how to improve this document, complete this form, publication [RA-DU002](#), available at <http://www.rockwellautomation.com/literature/>.

Rockwell Automation maintains current product environmental information on its website at <http://www.rockwellautomation.com/rockwellautomation/about-us/sustainability-ethics/product-environmental-compliance.page>.

Rockwell Otomasyon Ticaret A.Ş., Kar Plaza İş Merkezi E Blok Kat:6 34752 İçerenköy, İstanbul, Tel: +90 (216) 5698400

www.rockwellautomation.com

Power, Control and Information Solutions Headquarters

Americas: Rockwell Automation, 1201 South Second Street, Milwaukee, WI 53204-2496 USA, Tel: (1) 414.382.2000, Fax: (1) 414.382.4444
Europe/Middle East/Africa: Rockwell Automation NV, Pegasus Park, De Kleetlaan 12a, 1831 Diegem, Belgium, Tel: (32) 2 663 0600, Fax: (32) 2 663 0640
Asia Pacific: Rockwell Automation, Level 14, Core F, Cyberport 3, 100 Cyberport Road, Hong Kong, Tel: (852) 2887 4788, Fax: (852) 2508 1846

Publication SYSLIB-RM031E-EN-P - February 2017

Supersedes Publication SYSLIB-RM031D-EN-P - January 2016

Copyright © 2017 Rockwell Automation, Inc. All rights reserved. Printed in the U.S.A.