

Rockwell Automation Library of Process Objects: Advanced Analog Input (P_AInAdv)

Version 3.5

IMPORTANT

This manual applies to the Rockwell Automation Library of Process Objects version 3.5 or earlier.
For Rockwell Automation Library of Process Objects version 5.0, see

- [PROCES-RM200](#)

For Rockwell Automation Library of Process Objects version 4.0 or later, use the following manuals:

- [PROCES-RM013](#) contains logic instructions
- [PROCES-RM014](#) contains display elements



Important User Information

Read this document and the documents listed in the additional resources section about installation, configuration, and operation of this equipment before you install, configure, operate, or maintain this product. Users are required to familiarize themselves with installation and wiring instructions in addition to requirements of all applicable codes, laws, and standards.

Activities including installation, adjustments, putting into service, use, assembly, disassembly, and maintenance are required to be carried out by suitably trained personnel in accordance with applicable code of practice.

If this equipment is used in a manner not specified by the manufacturer, the protection provided by the equipment may be impaired.

In no event will Rockwell Automation, Inc. be responsible or liable for indirect or consequential damages resulting from the use or application of this equipment.

The examples and diagrams in this manual are included solely for illustrative purposes. Because of the many variables and requirements associated with any particular installation, Rockwell Automation, Inc. cannot assume responsibility or liability for actual use based on the examples and diagrams.

No patent liability is assumed by Rockwell Automation, Inc. with respect to use of information, circuits, equipment, or software described in this manual.

Reproduction of the contents of this manual, in whole or in part, without written permission of Rockwell Automation, Inc., is prohibited.

Throughout this manual, when necessary, we use notes to make you aware of safety considerations.



WARNING: Identifies information about practices or circumstances that can cause an explosion in a hazardous environment, which may lead to personal injury or death, property damage, or economic loss.



ATTENTION: Identifies information about practices or circumstances that can lead to personal injury or death, property damage, or economic loss. Attentions help you identify a hazard, avoid a hazard, and recognize the consequence.

IMPORTANT

Identifies information that is critical for successful application and understanding of the product.

Labels may also be on or inside the equipment to provide specific precautions.



SHOCK HAZARD: Labels may be on or inside the equipment, for example, a drive or motor, to alert people that dangerous voltage may be present.



BURN HAZARD: Labels may be on or inside the equipment, for example, a drive or motor, to alert people that surfaces may reach dangerous temperatures.



ARC FLASH HAZARD: Labels may be on or inside the equipment, for example, a motor control center, to alert people to potential Arc Flash. Arc Flash will cause severe injury or death. Wear proper Personal Protective Equipment (PPE). Follow ALL Regulatory requirements for safe work practices and for Personal Protective Equipment (PPE).

Preface	Software Compatibility and Content Revision.....	5
	Additional Resources.....	6
Advanced Analog Input (P_AlnAdv)	Guidelines.....	8
	Functional Description.....	9
	Required Files.....	11
	Controller File.....	11
	Visualization Files.....	11
	Controller Code.....	13
	Input Structure for Advanced Analog Input.....	13
	Output Structure for Advanced Analog Input.....	19
	Local Configuration Tags for Advanced Analog Input.....	24
	Operations.....	24
	Modes.....	24
	Alarms.....	25
	Simulation.....	26
	Execution.....	26
	Programming Example.....	27
	Display Elements.....	27
	Status/Quality Indicators.....	30
	Threshold Indicators.....	31
	Mode Indicators.....	31
	Alarm Indicators.....	32
	Maintenance Bypass Indicator.....	32
	Using Display Elements.....	33
	Quick Display.....	34
	Faceplate.....	35
	Operator Tab.....	36
	Maintenance Tab.....	39
	Engineering Tab.....	41
	Trends Tab.....	46
	Alarms Tab.....	48
	Advanced Analog Input Faceplate Help.....	50

Notes:

This manual contains new and updated information. Changes throughout this revision are marked by change bars, as shown to the right of this paragraph.

Software Compatibility and Content Revision

Table 1 - Summary of Changes

Topic	Page
Changed version from 3_1 to 3_5	11
Visualization Files - Split visualization files table by type and reordered to align with installation requirements	11
Updated Alarm descriptions	25
Updated Status/Quality Indicator descriptions.	30

For the latest compatible software information and to download the Rockwell Automation® Library of Process Objects, see the Product Compatibility and Download Center at <http://www.rockwellautomation.com/rockwellautomation/support/pcdc.page>.

For general library considerations, see Rockwell Automation Library of Process Objects, publication [PROCES-RM002](#).

Additional Resources

These documents contain additional information concerning related products from Rockwell Automation.

Resource	Description
PlantPAx® Distribution Control System Selection Guide, publication PROCES-SG001	Provides information to assist with equipment procurement for your PlantPAx system.
PlantPAx Distribution Control System Reference Manual, publication PROCES-RM001	Provides characterized recommendations for implementing your PlantPAx system.
Rockwell Automation Library of Process Objects, publication PROCES-RM002	Provides general considerations for the PlantPAx system library of process objects.
FactoryTalk® View Machine Edition User Manual, publication VIEWME-UM004	Provides details on how to use this software package for creating an automation application.
FactoryTalk View Site Edition User Manual, publication VIEWSE-UM006	Provides details on how to use this software package for developing and running human-machine interface (HMI) applications that can involve multiple users and servers, distributed over a network.
Logix5000™ Controllers Add-On Instructions Programming Manual, publication 1756-PM010	Provides information for designing, configuring, and programming Add-On Instructions.
Rockwell Automation Library of Process Objects: Analog Input Reference Manual, publication SYSLIB-RM001	Provides information on how to use the AOI to monitor one analog value, typically from a channel of an analog input module, and deal with alarms when the analog value exceeds user-specified thresholds (high and low).
Rockwell Automation Library of Process Objects: Common Alarm Block (P_Alarm) Reference Manual, publication SYSLIB-RM002	Details how to monitor an input condition to raise an alarm. Information includes acknowledging, resetting, inhibiting, and disabling an alarm. Generally the P_Alarm faceplate is accessible from the Alarms tab.
Rockwell Automation Library of Process Objects: Common Mode Block (P_Mode) Reference Manual, publication SYSLIB-RM005	Explains how to choose the Mode (owner) of an instruction or control strategy. The Mode instruction is usually embedded within other instructions to extend their functionality. It is possible to use a standalone Mode instruction to enhance a program where modes are wanted.
Rockwell Automation Library of Process Objects: Condition Gate Delay (P_Gate) Reference Manual, publication SYSLIB-RM041	Provides details for using the P_Gate instruction to process status and alarm conditions, including gate delay, on-delay, and off-delay timing. Generally the P_Gate faceplate is accessible from the Maintenance tab.

You can view or download publications at <http://www.rockwellautomation.com/literature/>. To order paper copies of technical documentation, contact your local Allen-Bradley distributor or Rockwell Automation sales representative.

Advanced Analog Input (P_AInAdv)

The P_AInAdv (Advanced Analog Input) Add-On Instruction monitors one analog value, typically from an Analog Input I/O module. The global objects and faceplate shown below are examples of the graphical interface tools for this Add-On Instruction.

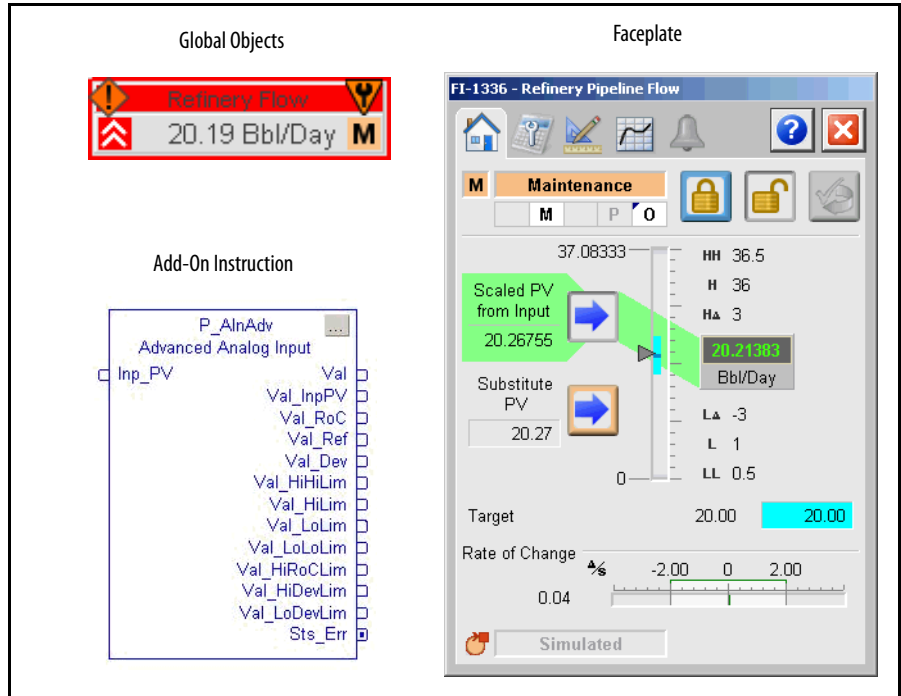

Guidelines

Use this instruction in these situations:

- You want to display a temperature, flow, pressure, level, or other signal from a field instrument on your HMI.
- You need any of the advanced features: square root characterization, deviation display/alarms, or rate of change display/alarms.

Do **not** use this instruction in these situations:

- You need only basic analog input features and don't need any of the advanced features. Use the P_AIn Analog Input instruction instead; it uses less memory and is processed faster.
- You need only to display a number on a screen and do not need any scaling, alarming, or faceplate features. Use an HMI numeric display object instead.
- You have dual sensors for a single process variable (for example, dual pH probes and transmitters) and need to choose one sensor, the other, or their average. Use the P_AInDual Analog Input Add-On Instruction instead.
- You have more than two sensors for one process variable and need to use the average or median sensor value. Use the P_AInMulti Multiple Analog Input instruction instead.

Functional Description

The diagram shows the functional characteristics of the P_AInAdv Add-On Instruction. The P_AInAdv instruction has functions for scaling, square root characterization, range checking, choosing a Substitute PV, filtering, providing threshold alarms, calculating the rate of change, providing rate of change alarms, entering a reference, and providing deviation alarms.

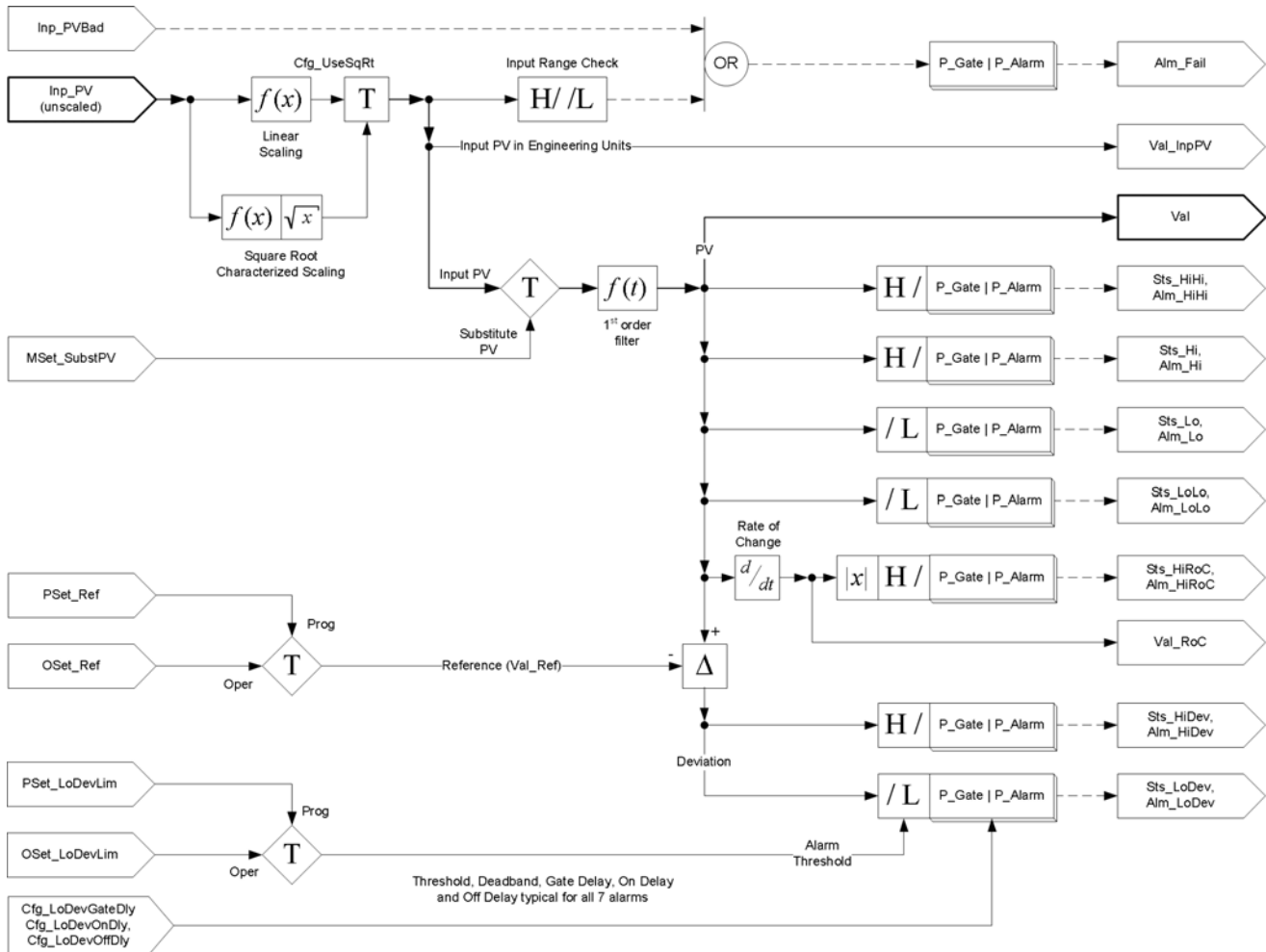

The P_AInAdv instruction provides the following capabilities:

- Linear scaling of the input value from raw (input card) units to engineering (display) units.
- High-High, High, Low, and Low-Low PV alarms with Operator- or Program-entered limits and configurable deadband and delay per alarm.
- Input Source and Quality monitoring of PV uncertain and PV bad inputs, plus monitoring of the PV for out-of-range condition and alarming on PV failure.
- PV filtering (first-order) to reduce signal noise.
- Maintenance capability to enter a substitute PV.
- Graphic Symbols, plus a faceplate with bar graph PV indication, mode selection, alarm limit entry and alarm display, configuration and acknowledgement, trending, and Maintenance and Engineering configuration and setup.
- Advanced features (unique to the P_AInAdv Advanced Analog Input instruction):
 - Square root characterized scaling of the input value from raw (input card) units to engineering (display) units. Square root characterized scaling is used with orifice plates or other pressure-differential elements for flow measurement when the transmitter does not provide square root characterization. The square root scaling in the P_AInAdv instruction works with \pm pressure differential to provide positive or negative flow values.
 - Operator or Program entry of a reference (setpoint) value with configurable alarms for PV deviation above or below the reference value.
 - Calculation of the PV rate of change and configurable high rate of change alarming.

Each of the advanced features can be individually selected on or off for a given PV (instruction instance).

Required Files

Add-On Instructions are reusable code objects that contain encapsulated logic that can streamline implementing your system. This lets you create your own instruction set for programming logic as a supplement to the instruction set provided natively in the ControlLogix® firmware. An Add-On Instruction is defined once in each controller project, and can be instantiated multiple times in your application code as needed.

Controller File

The P_AlnAdv_3_5-00_AOIL5X Add-On Instruction must be imported into the controller project to be used in the controller configuration. The service release number (boldfaced) can change as service revisions are created.

Visualization Files

<http://www.rockwellautomation.com/global/support/pcdc.page> This Add-On Instruction has associated visualization files that provide a common user interface. These files can be downloaded from the Product Compatibility and Download Center at <http://www.rockwellautomation.com/rockwellautomation/support/pcdc.page>.

IMPORTANT The visualization file dependencies require Process Library content imports to occur in a specific order as reflected in the following tables:

- Images
- Global Objects
- Standard Displays
- HMI Tags
- Macros

Images are external graphic files that can be used in displays. They must be imported for FactoryTalk View to make use of them.

When PNG files are imported, they are renamed by FactoryTalk View with a .bmp file extension, but retain a .png format.

Table 2 - Visualization Files: Images (.png)

FactoryTalk View SE Software	FactoryTalk View ME Software	Description
All .png files in the images folder	All .png files in the images folder	These are the common icons used in the global objects and standard displays for all Process Objects.

The Global Object files (.ggfx file type) in the following table are Process Library display elements that are created once and referenced multiple times on multiple displays in an application. When changes are made to a Global Object, all instances in the application are automatically updated.

Table 3 - Visualization Files: Global Objects (.ggfx)

FactoryTalk View SE Software	FactoryTalk View ME Software	Description
(RA-BAS) Common Faceplate Objects	(RA-BAS-ME) Common Faceplate Objects	Global objects used on process object faceplates.
(RA-BAS) P_Aln Graphics Library	(RA-BAS-ME) P_Aln Graphics Library	Analog Input global object device symbols used to build process graphics.
(RA-BAS) Process Alarm Objects	(RA-BAS-ME) Process Alarm Objects	Global objects used for managing alarms on process object faceplates.
(RA-BAS) Process Faceplate Analog Objects	(RA-BAS-ME) Process Faceplate Analog Objects	Analog global objects used on process object faceplates.
(RA-BAS) Process Help Objects	(RA-BAS-ME) Process Help Objects	Global objects used for all process objects help displays.
(RA-BAS) Process Mode Objects	(RA-BAS-ME) Process Mode Objects	Global objects used for managing modes on process object faceplates.

The Standard Display files (.gfx file type) in the following table are the Process Library displays that you see at runtime.

Table 4 - Visualization Files: Standard Displays (.gfx)

FactoryTalk View SE Software	FactoryTalk View ME Software	Description
(RA-BAS) Common-AnalogEdit	N/A	Faceplate used for analog input data entry. The FactoryTalk View ME faceplates use the native analog input data entry so no file is required.
(RA-BAS) P_AlnAdv-Faceplate	(RA-BAS-ME) P_AlnAdv-Faceplate	The faceplate that is used for the object.
(RA-BAS) P_AlnAdv-Quick	(RA-BAS-ME) P_AlnAdv-Quick	The Quick display that is used for the object.
(RA-BAS) P_Alarm-Faceplate	(RA-BAS-ME) P_Alarm-Faceplate	The faceplate that is used for the object
(RA-BAS) P_Alarm-Help	(RA-BAS-ME) P_Alarm-Help	Alarm Help information that is accessed from the P_Alarm faceplate.
(RA-BAS) P_Gate-Faceplate	(RA-BAS-ME) P_Gate-Faceplate	The gate faceplate display used for the object.
(RA-BAS) P_Mode-Config	(RA-BAS-ME) P_Mode-Config	The Configuration Display used to configure the P_Mode object.
(RA-BAS) P_Mode-Help	(RA-BAS-ME) P_Mode-Help	Mode Help information that is accessed from the Help faceplate.
(RA-BAS) Process AnalogIn Family-Help	(RA-BAS-ME) Process AnalogIn Family-Help	The Help display for AnalogIn objects
(RA-BAS) P_AIChan-Faceplate	(RA-BAS-ME) P_AIChan-Faceplate	Optional The Channel faceplate used for the object. Use this file if your Analog Input has an associated P_AIChan object and you enable navigation to its faceplate from the Analog Input faceplate.
(RA-BAS) P_AIChan-Help	(RA-BAS-ME) P_AIChan-Help	Optional Channel Help information that is accessed from the P_AIChan Help faceplate. Use this file if you use the Analog Input Channel faceplate.

HMI Tags are created in a FactoryTalk View ME application to support tab switching on Process Library faceplates. The HMI tags may be imported via the comma-separated values file (.csv file type) in the following table.

Table 5 - Visualization Files: HMI Tags (.csv)

FactoryTalk View SE Software	FactoryTalk View ME Software	Description
N/A	FTVME_PlantPaxLib_Tags_3_5_XX.csv where XX = the service release number.	These tags must be imported into the FactoryTalk View ME project to support switching tabs on any Process Object faceplate.

Controller Code

This section describes the parameter references for this Add-On Instruction.

Input Structure for Advanced Analog Input

Input parameters include the following:

- Input data elements (Inp_) are typically used to connect field inputs from I/O modules or signals from other objects.
- Configuration data elements (Cfg_) are used to set configurable capabilities and features of the instruction.
- Commands (PCmd_, OCmd_, MCmd_) are used by program logic, operators, and maintenance personnel to request instruction actions.
- Settings (PSet_, OSet_, MSet_) are used by program logic, operators, and maintenance personnel to establish runtime setpoints, thresholds, and so forth. A Setting (without a leading P, O, or M) establishes runtime settings regardless of role or mode.

Table 7 - P_AlnAdv Input Parameters

Input Parameter	Data Type	Alias For	Default	Description
EnableIn	BOOL		1	<p>Ladder Diagram: If the rung-in condition is true, the instruction's Logic routine executes. If the rung-in condition is false, the instruction's EnableInFalse routine executes.</p> <p>Function Block Diagram: If true, or not connected, the instruction's Logic routine executes. If the parameter is exposed as a pin and wired, and the pin is false, the instruction's EnableInFalse routine executes.</p> <p>Structured Text: No effect. The instruction's Logic routine executes.</p>
Inp_PVSrcq	SINT		0	Input Source and Quality (from Channel object, if available) (enumeration).
Inp_PV	REAL		0.0	Input signal (process variable) from sensor.
Inp_PVBad	BOOL		0	Bad Signal Quality/Communication Status for Input (1 = Bad, 0 = OK). If PV is read from an analog input, then this is normally read from the analog input channel fault status.
Inp_PVUncertain	BOOL		0	Uncertain Quality for Input (1 = Uncertain, 0 = OK). This is optional status for the input that can be used to drive the status of the output (Sts_PVUncertain).
Inp_Sim	BOOL		0	Simulation input. When set to 1, the instruction uses simulation parameters (for example, Set_SimPV) to calculate output. When set to 0, the instruction uses input parameters (for example, Inp_PV) to calculate output.
Inp_HiHiGate	BOOL	HiHiGate.Inp_Gate	1	<p>These parameters are the gate inputs used for status detection. When set to 1, the corresponding analog input threshold monitoring is enabled. When enabled, the threshold detection on-delay and off-delay timers are applied after the gate delay timer. When set to 0, detection is disabled and the corresponding status output is forced off.</p> <p>If the status is used as an alarm, this input acts as a suppression-by-design condition.</p>
Inp_HiGate		HiGate.Inp_Gate		
Inp_LoGate		LoGate.Inp_Gate		
Inp_LoLoGate		LoLoGate.Inp_Gate		
Inp_HiRoCGate		HiRoCGate.Inp_Gate		
Inp_HiDevGate		HiDevGate.Inp_Gate		
Inp_LoDevGate		LoDevGate.Inp_Gate		
Inp_FailGate		FailGate.Inp_Gate		

Table 7 - P_AlnAdv Input Parameters

Input Parameter	Data Type	Alias For	Default	Description
Inp_Reset	BOOL		0	Input parameter used to programatically reset alarms. When set to 1, all alarms requiring reset are reset.
Cfg_UseSqrt	BOOL		0	1 = Use square root scaling characterization for input from a differential pressure instrument to linearize to flow units. 0 = Use linear scaling.
Cfg_HasRoC	BOOL		0	1 = Enables the rate of change calculation and High Rate of Change alarm.
Cfg_HasDev	BOOL		0	1 = Enables reference entry and deviation calculation and alarms.
Cfg_NoSubstPV	BOOL		0	1 = Disallow selection of substitute PV.
Cfg_HasChanObj	BOOL		0	1 = Tells HMI a channel object (for example, P_AIChan) is used for Inp_PV and navigation to the channel object's faceplate is enabled. IMPORTANT: The name of the Channel object in the controller must be this object's name with the suffix '_Chan'. For example, if your P_AlnAdv object has the name 'AlnAdv123', then its Channel object must be named 'AlnAdv123_Chan'.
Cfg_SetTrack	BOOL		1	1 = PSets track OSets in Operator, OSets track PSets in Program 0 = No tracking
Cfg_PCmdClear	BOOL	Mode.Cfg_PCmdClear	1	When this parameter is 1, program commands are cleared once they are acted upon. When set to 0, program commands remain set until cleared by the application program logic. IMPORTANT: Clearing this parameter online can cause unintended program command execution.
Cfg_ProgDefault	BOOL	Mode.Cfg_ProgDefault	0	This parameter defines the default mode. When this parameter is 1, the mode defaults to Program if no mode is being requested. When this parameter is 0, the mode defaults to Operator if no mode is being requested. IMPORTANT: Changing this parameter online can cause unintended mode changes.
Cfg_HasHiHiAlm	BOOL	HiHi.Cfg_Exists	0	These parameters determine whether the corresponding alarm exists and is checked or if the alarm does not exist and is not used. When these parameters are 1, the corresponding alarm exists.
Cfg_HasHiAlm		Hi.Cfg_Exists		
Cfg_HasLoAlm		Lo.Cfg_Exists		
Cfg_HasLoLoAlm		LoLo.Cfg_Exists		
Cfg_HasHiRoCAlm		HiRoC.Cfg_Exists		
Cfg_HasHiDevAlm		HiDev.Cfg_Exists		
Cfg_HasLoDevAlm		LoDev.Cfg_Exists		
Cfg_HasFailAlm		Fail.Cfg_Exists		
Cfg_HiHiResetReqd	BOOL	HiHi.Cfg_ResetReqd	0	These parameters determine whether a reset is required to clear the alarm status. When these parameters are 1, the alarm is latched ON when the alarm occurs. After the alarm condition returns to normal, a reset is required to clear the alarm status (for example, OCmd_Reset, Inp_Reset, or Hi.OCmd_Reset are required to clear Alm_Hi alarm after the alarm is set and the value returns to normal). When these parameters are 0, no reset is required and the alarm status is cleared when the alarm condition returns to normal. IMPORTANT: If the reset clears the alarm, it also acknowledges the alarm.
Cfg_HiResetReqd		Hi.Cfg_ResetReqd		
Cfg_LoResetReqd		Lo.Cfg_ResetReqd		
Cfg_LoLoResetReqd		LoLo.Cfg_ResetReqd		
Cfg_HiRoCResetReqd		HiRoC.Cfg_ResetReqd		
Cfg_HiDevResetReqd		HiDev.Cfg_ResetReqd		
Cfg_LoDevResetReqd		LoDev.Cfg_ResetReqd		
Cfg_FailResetReqd		Fail.Cfg_ResetReqd		

Table 7 - P_AlnAdv Input Parameters

Input Parameter	Data Type	Alias For	Default	Description
Cfg_HiHiAckReqd	BOOL	HiHi.Cfg_AckReqd	1	These parameters determine whether an acknowledgement is required for an alarm. When these parameters are 1, the acknowledge (ack) bit is cleared when the alarm occurs. An acknowledge command (for example, PCmd_FailAck or Fail.OCmd_Ack) is required to acknowledge the alarm. When set to 0, the Acknowledge bit is set when an alarm occurs indicating an acknowledged alarm and no acknowledge command is required.
Cfg_HiAckReqd		Hi.Cfg_AckReqd		
Cfg_LoAckReqd		Lo.Cfg_AckReqd		
Cfg_LoLoAckReqd		LoLo.Cfg_AckReqd		
Cfg_HiRoCAckReqd		HiRoC.Cfg_AckReqd		
Cfg_HiDevAckReqd		HiDev.Cfg_AckReqd		
Cfg_LoDevAckReqd		LoDev.Cfg_AckReqd		
Cfg_FailAckReqd		Fail.Cfg_AckReqd		
Cfg_HiHiSeverity	INT	HiHi.Cfg_Severity	750	These parameters determine the severity of each alarm. This drives the color and symbol that are used to indicate alarm status on the faceplate and global object. The following are valid values: 1...250 = Low 251...500 = Medium 501...750 = High 751...1000 = Urgent IMPORTANT: For FactoryTalk View software, version 7.0, these severity parameters drive only the indication on the global object and faceplate. The FactoryTalk Alarms and Events definition of severity drives the color and symbol that is used on the alarm banner and alarm summary as well as the value returned by FactoryTalk Alarms and Events display commands.
Cfg_HiSeverity		Hi.Cfg_Severity	500	
Cfg_LoSeverity		Lo.Cfg_Severity	500	
Cfg_LoLoSeverity		LoLo.Cfg_Severity	750	
Cfg_HiRoCSeverity		HiRoC.Cfg_Severity	1000	
Cfg_HiDevSeverity		HiDev.Cfg_Severity	750	
Cfg_LoDevSeverity		LoDev.Cfg_Severity	750	
Cfg_FailSeverity		Fail.Cfg_Severity	750	
Cfg_InpRawMin	REAL		0.0	These parameters must be set to the range of the signal connected to the Inp_PV input. The input is then scaled to the values set by Cfg_PVEUMin and Cfg_PVEUMax.
Cfg_InpRawMax	REAL		100.0	
Cfg_PVEUMin	REAL		0.0	PV (Output) minimum for scaling to engineering units.
Cfg_PVEUMax	REAL		100.0	PV (Output) maximum for scaling to engineering units. TIP: The P_AlnAdv instruction supports reverse scaling; either the raw (Input) or engineering (Scaled) range can be reversed (maximum less than minimum).
Cfg_FiltTC	REAL		0.0	PV filter time constant (seconds), 0.0 = unfiltered.
Cfg_RateTime	REAL		1.0	PV Rate of Change time base (seconds) 60=/minute, 3600=/hour.
Cfg_HiHiDB	REAL		1.0	These parameters set the deadband (hysteresis) that is applied to each alarm limit. This is used to prevent a noisy signal from generating spurious alarms. EXAMPLE: If the High Alarm is enabled (Cfg_HasHiAlm = 1), the High Alarm Limit (Val_HiLim) is 90 and the High Alarm Deadband (Cfg_HiDB) is 5, the high alarm is generated when the output (Val) rises above 90 and is cleared once the output (Val) falls below 85 (90 minus 5).
Cfg_HiDB			1.0	
Cfg_LoDB			1.0	
Cfg_LoLoDB			1.0	
Cfg_FailDB			0.0	
Cfg_HiRoCDB			1.0	
Cfg_HiDevDB			1.0	
Cfg_LoDevDB			1.0	

Table 7 - P_AlnAdv Input Parameters

Input Parameter	Data Type	Alias For	Default	Description
Cfg_HiHiGateDly		HiHiGate.Cfg_GateDly	0	These parameters determine the amount of time (in seconds) the gate input must be turned on for threshold detection to be enabled. On delays and off delays are applied after the gate delay is complete.
Cfg_HiGateDly		HiGate.Cfg_GateDly		
Cfg_LoGateDly		LoGate.Cfg_GateDly		
Cfg_LoLoGateDly		LoLoGate.Cfg_GateDly		
Cfg_HiRoCGateDly		HiRoCGate.Cfg_GateDly		
Cfg_HiDevGateDly		HiDevGate.Cfg_GateDly		
Cfg_LoDevGateDly		LoDevGate.Cfg_GateDly		
Cfg_FailGateDly		FailGate.Cfg_GateDly		
Cfg_HiHiOnDly	DINT	HiHiGate.Cfg_OnDly	0	These parameters determine the minimum time (in seconds) the PV must remain beyond the status threshold for the status to be set. On-delay times are used to avoid unnecessary alarms when an output (Val) only briefly overshoots its threshold (for example, Val_HiHiLim).
Cfg_HiOnDly		HiGate.Cfg_OnDly		
Cfg_LoOnDly		LoGate.Cfg_OnDly		
Cfg_LoLoOnDly		LoLoGate.Cfg_OnDly		
Cfg_HiRoCOnDly		HiRoCGate.Cfg_OnDly		
Cfg_HiDevOnDly		HiDevGate.Cfg_OnDly		
Cfg_LoDevOnDly		LoDevGate.Cfg_OnDly		
Cfg_FailOnDly		FailGate.Cfg_OnDly		
Cfg_HiHiOffDly	DINT	HiHiGate.Cfg_OffDly	0	These parameters determine the amount of time (in seconds) the output must stay within each status threshold to clear the status. Off-delay times are used to reduce chattering alarms. EXAMPLE: If Cfg_HiOffDly is 5 seconds, the output (Val) must be below the status limit (Val_HiHiLim) minus deadband (Cfg_HiHiDB) for 5 seconds before the status is returned to normal.
Cfg_HiOffDly		HiGate.Cfg_OffDly		
Cfg_LoOffDly		LoGate.Cfg_OffDly		
Cfg_LoLoOffDly		LoLoGate.Cfg_OffDly		
Cfg_HiRoCOffDly		HiRoCGate.Cfg_OffDly		
Cfg_HiDevOffDly		HiDevGate.Cfg_OffDly		
Cfg_LoDevOffDly		LoDevGate.Cfg_OffDly		
Cfg_FailOffDly		FailGate.Cfg_OffDly		
Cfg_FailHiLim	REAL		103.9583	Out-of-Range (fail) High Limit (engineering units).
Cfg_FailLoLim	REAL		-2.08333	Out-of-Range (fail) Low Limit (engineering units).
PSet_Ref	REAL		0.0	Program reference setting for Deviation alarms (engineering units).
PSet_Owner	DINT		0	Program Owner Request ID (non-zero) or Release (zero).
PSet_HiHiLim	REAL		1.50E+38	Program-Entered High-High status threshold (engineering units).
PSet_HiLim	REAL		1.50E+38	Program-Entered High status threshold (engineering units).
PSet_LoLim	REAL		-1.50E+38	Program-Entered Low status threshold (engineering units).
PSet_LoLoLim	REAL		-1.50E+38	Program-Entered Low-Low status threshold (engineering units).
PSet_HiRoCLim	REAL		1.50E+38	Program-Entered High Rate of Change status threshold (engineering units).
PSet_HiDevLim	REAL		1.50E+38	Program-Entered High Deviation status threshold (engineering units).
PSet_LoDevLim	REAL		-1.50E+38	Program-Entered Low Deviation status threshold (engineering units).
OSet_Ref	REAL		0.0	Operator reference setting for Deviation alarms (engineering units).
MSet_SubstPV	REAL		0.0	Maintenance-Entered substitute PV (engineering units).
OSet_HiHiLim	REAL		1.50E+38	Operator-Entered High-High Status threshold (engineering units).
OSet_HiLim	REAL		1.50E+38	Operator-Entered High status threshold (engineering units).

Table 7 - P_AlnAdv Input Parameters

Input Parameter	Data Type	Alias For	Default	Description
OSet_LoLim	REAL		-1.50E+38	Operator-Entered Low status threshold (engineering units).
OSet_LoLoLim	REAL		-1.50E+38	Operator-Entered Low-Low status threshold (engineering units).
OSet_HiRoCLim	REAL		1.50E+38	Operator-Entered High Rate of Change status threshold (engineering units).
OSet_HiDevLim	REAL		1.50E+38	Operator-Entered High Deviation status threshold (engineering units).
OSet_LoDevLim	REAL		-1.50E+38	Operator-Entered Low Deviation status threshold (engineering units).
Set_SimPV	REAL		0.0	PV used in simulation (Inp_Sim = 1) (engineering units).
PCmd_ClearCapt	BOOL		0	<ul style="list-style-type: none"> Set PCmd_ClearCapt to 1 to clear the captured minimum/maximum PV excursion values The parameter is reset Automatically
PCmd_Acq	BOOL	Mode.PCmd_Acq	0	<p>When Cfg_PCmdClear is 1:</p> <ul style="list-style-type: none"> Set PCmd_Acq to 1 to Acquire Set PCmd_Rel to 1 to Release These parameters reset automatically <p>When Cfg_PCmdClear is 0:</p> <ul style="list-style-type: none"> Set PCmd_Acq to 1 to Acquire Set PCmd_Acq to 0 to Release PCmd_Rel is not used These parameters do not reset automatically
PCmd_Rel		Mode.PCmd_Rel		
PCmd_Lock	BOOL	Mode.PCmd_Lock	0	<p>When Cfg_PCmdClear is 1:</p> <ul style="list-style-type: none"> Set PCmd_Lock to 1 to Lock Set PCmd_Unlock to 1 to Unlock These parameters reset automatically <p>When Cfg_PCmdClear is 0:</p> <ul style="list-style-type: none"> Set PCmd_Lock to 1 to Lock Set PCmd_Lock to 0 to Unlock PCmd_Unlock is not used These parameters do not reset automatically
PCmd_Unlock		Mode.PCmd_Unlock		
PCmd_Reset	BOOL		0	<ul style="list-style-type: none"> Set PCmd_Reset to 1 to reset all alarms requiring reset This parameter is always reset automatically
PCmd_HiHiAck	BOOL	HiHi.PCmd_Ack	0	<ul style="list-style-type: none"> Set PCmd_<Alarm>Ack to 1 to Acknowledge alarm The parameter is reset automatically
PCmd_HiAck		Hi.PCmd_Ack		
PCmd_LoAck		Lo.PCmd_Ack		
PCmd_LoLoAck		LoLo.PCmd_Ack		
PCmd_HiRoCAck		HiRoC.PCmd_Ack		
PCmd_HiDevAck		HiDev.PCmd_Ack		
PCmd_LoDevAck		LoDev.PCmd_Ack		
PCmd_FailAck		Fail.PCmd_Ack		

Table 7 - P_AlnAdv Input Parameters

Input Parameter	Data Type	Alias For	Default	Description
PCmd_HiHiSuppress	BOOL	HiHi.PCmd_Suppress	0	When Cfg_PCmdClear is 1: <ul style="list-style-type: none"> Set PCmd_<Alarm>Suppress to 1 to suppress alarm Set PCmd_<Alarm>Unsuppress to 1 to unsuppress alarm These parameters reset automatically When Cfg_PCmdClear is 0: <ul style="list-style-type: none"> Set PCmd_<Alarm>Suppress to 1 to suppress alarm Set PCmd_<Alarm>Suppress to 0 to unsuppress alarm PCmd_<Alarm>Unsuppress is not used These Parameters do not reset automatically
PCmd_HiSuppress		Hi.PCmd_Suppress		
PCmd_LoSuppress		Lo.PCmd_Suppress		
PCmd_LoLoSuppress		LoLo.PCmd_Suppress		
PCmd_FailSuppress		HiRoC.PCmd_Suppress		
PCmd_HiRoCSuppress		HiDev.PCmd_Suppress		
PCmd_HiDevSuppress		LoDev.PCmd_Suppress		
PCmd_LoDevSuppress		Fail.PCmd_Suppress		
PCmd_HiHiUnsuppress		HiHi.PCmd_Unsuppress		
PCmd_HiUnsuppress		Hi.PCmd_Unsuppress		
PCmd_LoUnsuppress		Lo.PCmd_Unsuppress		
PCmd_LoLoUnsuppress		LoLo.PCmd_Unsuppress		
PCmd_HiRoCUnsuppress		HiRoC.PCmd_Unsuppress		
PCmd_HiDevUnsuppress		HiDev.PCmd_Unsuppress		
PCmd_LoDevUnsuppress		LoDev.PCmd_Unsuppress		
PCmd_FailUnsuppress		Fail.PCmd_Unsuppress		
PCmd_HiHiUnshelve	BOOL	HiHi.PCmd_Unshelve	0	<ul style="list-style-type: none"> Set PCmd_<Alarm>Unshelve to 1 to Unshelve alarm The parameter is reset automatically
PCmd_HiUnshelve		Hi.PCmd_Unshelve		
PCmd_LoUnshelve		Lo.PCmd_Unshelve		
PCmd_LoLoUnshelve		LoLo.PCmd_Unshelve		
PCmd_HiRoCUnshelve		HiRoC.PCmd_Unshelve		
PCmd_HiDevUnshelve		HiDev.PCmd_Unshelve		
PCmd_LoDevUnshelve		LoDev.PCmd_Unshelve		
PCmd_FailUnshelve		Fail.PCmd_Unshelve		
MCmd_SubstPV	BOOL		0	Maintenance command to use Substitute PV.
MCmd_InpPV	BOOL		0	Maintenance command to use Input PV (normal).
OCmd_ClearCapt	BOOL		0	Operator command to clear the captured minimum/maximum PV excursion values.
MCmd_Acq	BOOL	Mode.MCmd_Acq	0	Maintenance command to acquire ownership (Operator/Program to Maintenance).
MCmd_Rel	BOOL	Mode.MCmd_Rel	0	Maintenance command to release ownership (Maintenance to Operator/Program).
OCmd_AcqLock	BOOL	Mode.OCmd_AcqLock	0	Operator command to acquire (Program to Operator)/lock ownership.
OCmd_Unlock	BOOL	Mode.OCmd_UnlockRel	0	Operator command to unlock/release (Operator to Program) ownership.
OCmd_Reset	BOOL		0	Operator command to reset all alarms requiring reset.
OCmd_ResetAckAll	BOOL		0	Operator command to reset and acknowledge all alarms.

Output Structure for Advanced Analog Input

Output parameters include the following:

- Value data elements (Val_) are numeric outputs of the instruction for use by the HMI. Values also can be used by other application logic or software packages.
- Source and Quality data elements (SrcQ_) are outputs of the instruction used by the HMI to indicate PV source and quality.
- Status data elements (Sts_) are bit outputs of the instruction for use by the HMI. Status bits also can be used by other application logic.
- Error data elements (Err_) are outputs of the instruction that indicate a particular configuration error. If any Err_bit is set, then the Sts_Err configuration error summary status is set and the Invalid Configuration indicator is displayed on the HMI.
- Alarm data elements (Alm_) are outputs of the instruction that indicate a particular alarm has occurred.
- Acknowledge data elements (Ack_) are outputs of the instruction that indicate the corresponding alarm has been acknowledged.
- Ready data elements (Rdy_) are bit outputs of the instruction used by the HMI to enable or disable Command buttons and Setting entry fields.

Table 8 - P_AlnAdv Output Parameters

Output Parameter	Data Type	Alias For	Description
EnableOut	BOOL		Enable Output: The EnableOut signal is not manipulated by this instruction. Its output state always reflects EnableIn input state.
Val	REAL		Analog input value (include Substitute PV, if used).
Val_InpPV	REAL		Analog input value (actual, before Substitute PV selection).
Val_RoC	REAL		Analog value Rate of Change (engineering units/rate time).
Val_Ref	REAL		Analog reference for Deviation alarms (engineering units).
Val_Dev	REAL		Calculated deviation from reference (engineering units).
Val_PVMinCapt	REAL		Captured PV minimum (excursion) since last cleared.
Val_PVMaxCapt	REAL		Captured PV maximum (excursion) since last cleared.
Val_PVEUMin	REAL		Minimum of scaled range = MIN (Cfg_PVEUMin, Cfg_PVEUMax).
Val_PVEUMax	REAL		Maximum of scaled range = MAX (Cfg_PVEUMin, Cfg_PVEUMax).

Table 8 - P_AlnAdv Output Parameters

Output Parameter	Data Type	Alias For	Description
SrcQ_IO	SINT		I/O signal source and quality.
SrcQ			Final PV Source and Quality. GOOD 0 = I/O live and confirmed good quality 1 = I/O live and assumed good quality 2 = No feedback configured, assumed good quality TEST 8 = Device simulated 9 = Device loopback simulation 10 = Manually entered value UNCERTAIN 16 = Live input, off-specification 17 = Value substituted at device/bus 18 = Value substituted by maintenance (Has and not Use) 19 = Shed, using last good value 20 = Shed, using replacement value BAD 32 = Signal failure (out-of-range, NaN, invalid combination) 33 = I/O channel fault 34 = I/O module fault 35 = Bad I/O configuration (for example, scaling parameters)
Val_Fault	SINT		Device fault status: 0 = None 20 = Low 21 = High 22 = Low Deviation 23 = High Deviation 24 = Low Low 25 = High High 26 = High Rate of Change 32 = Fail 34 = Configuration Error
Val_Mode	SINT	Mode.Val	The current mode is shown with status bits and also as an enumeration 'Val_Mode' as follows: 0 = No mode 2 = Maintenance 4 = Program (locked) 5 = Operator (locked) 6 = Program (unlocked, Operator is default) 7 = Operator (unlocked, Program is default) 8 = Program (unlocked, Program is default) 9 = Operator (unlocked, Operator is default)
Val_Owner	DINT		Current object owner ID (0=not owned).
Val_Notify	SINT		Current alarm level and acknowledgement (enumeration): 0 = No alarm 1 = Alarm cleared: a reset or acknowledge is required 2 = Low (acknowledged) 3 = Low (unacknowledged) 4 = Medium (acknowledged) 5 = Medium (unacknowledged) 6 = High (acknowledged) 7 = High (unacknowledged) 8 = Urgent (acknowledged) 9 = Urgent (unacknowledged)

Table 8 - P_AlnAdv Output Parameters

Output Parameter	Data Type	Alias For	Description
Val_HiHiLim	REAL		Current status threshold.
Val_HiLim			
Val_LoLim			
Val_LoLoLim			
Val_HiRoCLim			
Val_HiDevLim			
Val_LoDevLim			
Sts_SubstPV	BOOL		1 = Using substitute PV (Input being overridden).
Sts_InpPV	BOOL		1 = Using input PV (normal).
Sts_PVBad	BOOL		1 = PV bad quality or out of range.
Sts_PVUncertain	BOOL		1 = PV value is uncertain (quality).
Sts_MaintByp	BOOL		1 = A Maintenance bypass is active, display icon.
Sts_Almlnh	BOOL		1 = An alarm is shelved, disabled or suppressed, display icon.
Sts_Err	BOOL		1 = Error in Configuration: see detail bits for reason.
Err_Raw	BOOL		1 = Error in Configuration raw input scaling minimum = maximum.
Err_EU	BOOL		1 = Error in Configuration: scaled engineering units minimum = maximum.
Err_Timer	BOOL		1 = Error in Configuration: gate delay, on delay, or off delay (use 0. . . 2,147,483 seconds).
Err_Filt	BOOL		1 = Error in Configuration: PV filter parameters (RateTime, Time Constant).
Err_DB	BOOL		1 = Error in Configuration: a status deadband is < 0.0.
Err_Alarm	BOOL		1 = Error in Configuration: alarm minimum on time or severity.
Sts_Maint	BOOL	Mode.Sts_Maint	1 = Mode is Maintenance (supersedes Program, Operator).
Sts_Prog	BOOL	Mode.Sts_Prog	1 = Mode is Program.
Sts_Oper	BOOL	Mode.Sts_Oper	1 = Mode is Operator.
Sts_ProgOperLock	BOOL	Mode.Sts_ProgOperLock	1 = Program or Operator has requested mode lock.
Sts_NoMode	BOOL	Mode.Sts_NoMode	1 = No mode (disabled because enableIn is false).
Sts_MAcqRcvd	BOOL	Mode.MAcqRcvd	1 = Maintenance Acquire command received this scan.
Sts_HiHiCmp	BOOL	HiHiGate.Inp	PV comparison result 1 = High-High, High, Low, Low-Low, High Rate of Change, High Deviation, Low Deviation, or Out of Range
Sts_HiCmp		HiGate.Inp	
Sts_LoCmp		LoGate.Inp	
Sts_LoLoCmp		LoLoGate.Inp	
Sts_HiRoCCmp		HiRoCGate.Inp	
Sts_HiDevCmp		HiDevGate.Inp	
Sts_LoDevCmp		LoDevGate.Inp	
Sts_FailCmp		FailGate.Inp	

Table 8 - P_AlnAdv Output Parameters

Output Parameter	Data Type	Alias For	Description
Sts_HiHiGate	BOOL	HiHiGate.Sts_Gate	PV High-High, PV High, PV Low, PV Low-Low, PV High Rate of Change, High Deviation, Low Deviation, or Fail gate delay status 1 = done.
Sts_HiGate		HiGate.Sts_Gate	
Sts_LoGate		LoGate.Sts_Gate	
Sts_LoLoGate		LoLoGate.Sts_Gate	
Sts_HiRoCGate		HiRoCGate.Sts_Gate	
Sts_HiDevGate		HiDevGate.Sts_Gate	
Sts_LoDevGate		LoDevGate.Sts_Gate	
Sts_FailGate		FailGate.Sts_Gate	
Sts_HiHi	BOOL	HiHi.Inp	1 = Analog input is above High-High or High limit.
Sts_Hi		Hi.Inp	
Sts_Lo		Lo.Inp	1 = Analog input is below Low or Low-Low limit.
Sts_LoLo		LoLo.Inp	
Sts_HiRoC		HiRoC.Inp	1 = Analog input Rate of Change or Deviation is above High limit.
Sts_HiDev		HiDev.Inp	
Sts_LoDev		LoDev.Inp	1 = Analog Input deviation is below Low limit.
Sts_Fail		Fail.Inp	1 = Analog input is Out of Range or PV Bad.
Alm_HiHi	BOOL	HiHi.Alm	1 = Analog input is in High-High, High, Low, Low-Low alarm.
Alm_Hi		Hi.Alm	
Alm_Lo		Lo.Alm	
Alm_LoLo		LoLo.Alm	
Alm_HiRoC		HiRoC.Alm	1 = Analog input Rate of Change is in High alarm.
Alm_HiDev		HiDev.Alm	1 = Analog input deviation is in High or Low alarm.
Alm_LoDev		LoDev.Alm	
Alm_Fail		Fail.Alm	1 = Analog input Failure alarm (Bad or Out of Range).
Ack_HiHi	BOOL	HiHi.Ack	1 = Alarm has been acknowledged.
Ack_Hi		Hi.Ack	
Ack_Lo		Lo.Ack	
Ack_LoLo		LoLo.Ack	
Ack_HiRoC		HiRoC.Ack	
Ack_HiDev		HiDev.Ack	
Ack_LoDev		LoDev.Ack	
Ack_Fail		Fail.Ack	

Table 8 - P_AlnAdv Output Parameters

Output Parameter	Data Type	Alias For	Description
Sts_HiHiDisabled	BOOL	HiHi.Disabled	1 = Alarm is disabled (by maintenance).
Sts_HiDisabled		Hi.Disabled	
Sts_LoDisabled		Lo.Disabled	
Sts_LoLoDisabled		LoLo.Disabled	
Sts_HiRoCDisabled		HiRoC.Disabled	
Sts_HiDevDisabled		HiDev.Disabled	
Sts_LoDevDisabled		LoDev.Disabled	
Sts_FailDisabled		Fail.Disabled	
Sts_HiHiShelved	BOOL	HiHi.Shelved	1 = Alarm is shelved (by operator).
Sts_HiShelved		Hi.Shelved	
Sts_LoShelved		Lo.Shelved	
Sts_LoLoShelved		LoLo.Shelved	
Sts_HiRoCShelved		HiRoC.Shelved	
Sts_HiDevShelved		HiDev.Shelved	
Sts_LoDevShelved		LoDev.Shelved	
Sts_FailShelved		Fail.Shelved	
Sts_HiHiSuppressed	BOOL	HiHi.Suppressed	1 = Alarm is suppressed (by program).
Sts_HiSuppressed		Hi.Suppressed	
Sts_LoSuppressed		Lo.Suppressed	
Sts_LoLoSuppressed		LoLo.Suppressed	
Sts_HiRoCSuppressed		HiRoC.Suppressed	
Sts_HiDevSuppressed		HiDev.Suppressed	
Sts_LoDevSuppressed		LoDev.Suppressed	
Sts_FailSuppressed		Fail.Suppressed	
Rdy_SubstPV	BOOL		1 = Ready for MCmd_SubstPV.
Rdy_InpPV	BOOL		1 = Ready for MCmd_InpPV.
Rdy_Reset	BOOL		1 = At least one alarm requires reset.
Rdy_ResetAckAll	BOOL		1 = At least one alarm requires reset or acknowledgement.
Rdy_OSet	BOOL		1 = Ready to receive OSets (enables data entry fields).
P_AlnAdv	BOOL		Unique parameter name for auto-discovery.

Local Configuration Tags for Advanced Analog Input

Configuration parameters that are array, string, or structure data types cannot be configured as parameters for Add-On Instructions. Configuration parameters of these types appear as local tags to the Add-On Instruction. Local tags can be configured through the HMI faceplates or in Studio 5000 Logix Designer® application by opening the Instruction Logic of the Add-On Instruction instance and then opening the Data Monitor on a local tag. These parameters cannot be modified by using controller logic or Logix Designer application export/import functionality.

Table 9 - P_AlnAdv Input Local Configuration Tags

Tag Name	Data Type	Default	Description
Cfg_Desc	STRING_40	'Advanced Analog Input'	Description for display on HMI. This string shows in the title bar of the faceplate.
Cfg_EU	STRING_8	'%'	Engineering units for display on HMI.
Cfg_Label	STRING_20	'Analog Input'	Label for graphic symbol displayed on HMI. This string appears on the graphic symbol.
Cfg_Tag	STRING_20	'P_AlnAdv'	Tag name for display on the HMI. This string shows in the title bar of the faceplate.

Operations

This section describes the primary operations for Add-On Instructions.

Modes

This instruction uses the following standard modes, which are implemented by using an embedded P_Mode Add-On Instruction.

Mode	Description
Operator	The Operator owns control of the device. Operator commands (OCmd_) and Operator settings (OSet_) from the HMI are accepted.
Program	Program logic owns control of the device. Program commands (PCmd_) and Program settings (PSet_) are accepted.
Maintenance	Maintenance owns control of the device and supersedes Operator, Program, and Override control. Operator commands and settings from the HMI are accepted. Bypassable interlocks and permissives are bypassed, and device timeout checks are not processed.
No Mode	The device is disabled and has no owner because the EnableIn input is false. The main instruction Logic routine is not being scanned. See Execution section for more information on EnableInFalse processing.

The following standard modes are not used:

- Hand mode
- Override (Ovrd) mode

See Rockwell Automation Library of Process Objects: Common Mode Block (P_Mode) Reference Manual, publication [SYSLIB-RM005](#), for more information.

Alarms

This instruction uses the following alarms, which are implemented by using embedded P_Alarm and P_Gate Add-On Instructions.

Alarm Name	P_Alarm Name	P_Gate Name	Description
Fail	Fail	FailGate	Raised when any of the following is true: <ul style="list-style-type: none"> The PV quality is bad The Inp_PVBad input is true The PV is outside the configured failure limits The PV is infinite or not a number (floating-point exception) The raw or engineering unit range configuration is invalid
High Deviation	HiDev	HiDevGate	Raised when the amount by which the PV exceeds the setpoint or reference is above the High Deviation threshold. The threshold is set by the operator or by program logic. Deadband, gating, and timing are set in configuration.
High PV	Hi	HiGate	Raised when the PV is above the High threshold. The threshold is set by the operator or by program logic. Deadband, gating, and timing are set in configuration.
High Rate of Change	HiRoC	HiRoCGate	Absolute value of PV rate of change above High Rate of Change limit. Limit set by Operator or Program. Deadband and severity in configuration.
High-High PV	HiHi	HiHiGate	Raised when the PV is above the High-High threshold. The threshold is set by the operator or by program logic. Deadband, gating, and timing are set in configuration.
High Rate of Change	HiRoC	HiRoCGate	Raised when the rate at which the PV is increasing or decreasing exceeds the High-Rate of Change threshold. The threshold is set by the operator or by program logic. Deadband, gating, and timing are set in configuration.
Low PV	Lo	LoGate	Raised when the PV is below the Low threshold. The threshold is set by the operator or by program logic. Deadband, gating, and timing are set in configuration.
Low Deviation	LoDev	LoDevGate	Raised when the amount by which the PV exceeds the setpoint or reference is below the Low Deviation threshold. (Since the threshold is a negative number, this is the amount the PV falls below the setpoint or reference.) The threshold is set by the operator or by program logic. Deadband, gating, and timing are set in configuration.
Low-Low PV	LoLo	LoLoGate	Raised when the PV is below the Low-Low threshold. The threshold is set by the operator or by program logic. Deadband, gating, and timing are set in configuration.

Parameters of the P_Alarm object can be accessed by using the following convention: [P_Alarm Name].[P_Alarm Parameter].

For more information, see the following Rockwell Automation Library of Process Objects publications:

- Common Alarm Block (P_Alarm) Reference Manual, publication [SYSLIB-RM002](#)

- Condition Gate Delay (P_Gate) Reference Manual, publication [SYSLIB-RM041](#)

Simulation

Simulation in P_AInAdv disables the normal input (Inp_PV) and provides an input on the Operator faceplate for you to enter your own input value.

You must set the Inp_Sim parameter in the controller to '1' to enable simulation. The

Simulation icon  is displayed at the bottom left of the Operator faceplate indicating the device is in simulation.

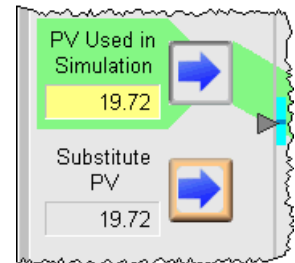

When you have finished in simulation, set the Inp_Sim parameter in the controller to '0' to return to normal operation.

Execution

The following table explains the handling of instruction execution conditions.

Condition	Description
EnableIn False (false rung)	The P_AInAdv instruction shows a status of bad quality (Sts_PVBad) on the HMI. All alarms are cleared. The mode is reported as No mode. However, calculation of the scaled input PV value is executed to indicate to the operator the actual input value, even though the primary PV (Val) is not updated (holds last value).
Powerup (prescan, first scan)	Any commands received before first scan are discarded. Embedded P_Mode and P_Alarm instructions are handled in accordance with their standard power-up procedure. Refer to the reference manuals for the P_Mode and P_Alarm instructions for more information.
Postscan (SFC transition)	No SFC postscan logic is provided.

Refer to the Logix5000™ Controllers Add-On Instructions Programming Manual, publication [1756-PM010](#), for more information.

Programming Example

For a generic programming example, see the Rockwell Automation Library of Process Objects: Basic Analog Input (P_AIn) Reference Manual, publication [SYSLIB-RM001](#).

The P_AInAdv Add-On Instruction has the following advanced features that are not included in the generic programming example:

- Square root characterization
- Deviation display/alarms
- Rate of change display/alarms

Display Elements

A display element (global object) is created once and can be referenced multiple times on multiple displays in an application. When changes are made to the original (base) object, the instantiated copies (reference objects) are automatically updated. Use of global objects, in conjunction with tag structures in the ControlLogix system, aid consistency and save engineering time.

Table 10 - P_AInAdv Display Elements Description

Display Element Name	Display Element	Description
GO_P_AIn		Standard analog input global object.
GO_P_AIn_Trend		Analog input with a trend of the primary value and limits (high-high, high, low, and low-low).
GO_P_AIn_Indicator		Primary value indicated by a moving triangle. The graphic display includes limits displayed with filled bars.

Table 10 - P_AlnAdv Display Elements Description



Display Element Name	Display Element	Description
GO_P_Aln_IndicatorWCapture		<p>This object is the same as the GO_P_Aln_Indicator plus a light gray minimum/maximum capture area.</p>
GO_P_AlnX		<p>Primary value displayed as a bar graph. The graphic display includes limits displayed as lines on the graph.</p>
GO_P_Aln_TrendWCapture		<p>The object is the same as GO_P_Aln_Trend except it displays a capture of the Primary Value.</p>
GO_P_AlnAdvTrend		<p>This graphic symbol includes a trend with target lines and is intended to be used for the Advanced Analog Input Add-On Instruction.</p>

Table 10 - P_AlnAdv Display Elements Description

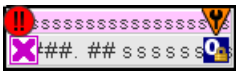
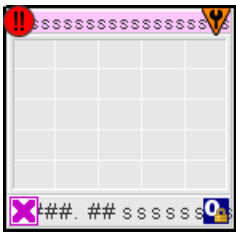
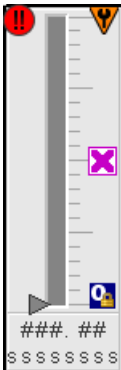
Display Element Name	Display Element	Description
GO_AlnAdv_Indicator		This graphic symbols is the same as GO_P_Aln_Indicator plus a cyan target range (for deviations).
GO_AlnAdv_IndicatorWCapture		This graphic symbol is the same as GO_P_AlnAdv_Indicator plus a light gray minimum/maximum capture area.



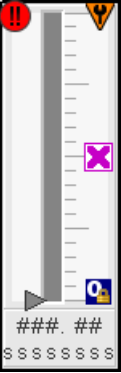
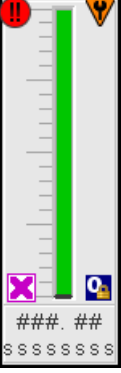
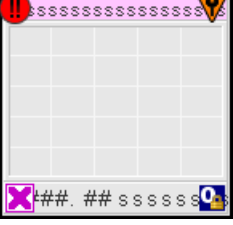

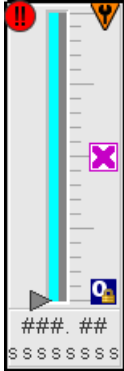
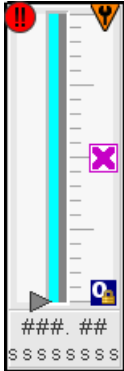
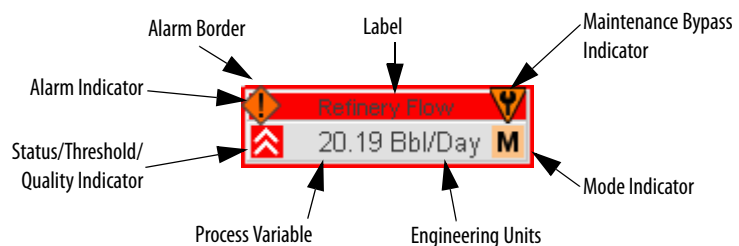
Common attributes of the P_AlnAdv global objects include the following:

- Current value of the PV with engineering units
- Status/threshold/quality indicator
- Maintenance bypass indicator
- Label
- Mode indicator
- Color changing alarm border that blinks on unacknowledged alarm
- Alarm indicator that changes color with the severity of an alarm



Status/Quality Indicators

One of these symbols appears on the graphic symbol when the described condition is true.

Graphic Symbol	Description
	Invalid configuration.
	Data quality bad/failure.
	Data Quality degraded: uncertain, test, simulation, substitution, or out of specification.
	The input or device has been disabled.
No symbol displayed	I/O communication and quality good, configuration valid.

TIP When the Invalid Configuration indicator appears, you can find what configuration setting is invalid by following the indicators. Click the graphic symbol to open the faceplate. The Invalid Configuration indicator appears next to the appropriate tab at the top of the faceplate to guide you in finding the configuration error. Once you navigate to the tab, the misconfigured item is flagged with this indicator or appears in a magenta box.







For the Advanced Analog Input instruction, the Invalid Configuration indicator appears under the following conditions:

- Input Raw Minimum and Raw Maximum scaling parameters are set to the same value.
- Scaled Engineering Units Minimum and Engineering Units Maximum scaling parameters are set to the same value.
- First-order filter time constant is set to a negative value.
- Time used for rate of change calculation is set to a negative or zero value. Use 1.0 for engineering units/sec, 60.0 for engineering units/min, 3600.0 for engineering units/hr, or a similar value
- Deadband is set to a negative value.
- Alarm Minimum OnTime is set to a value less than zero or greater than 2,147,483 seconds.
- Alarm Severity is set to a value less than 1 or greater than 1000.

Threshold Indicators







These indicators show that the PV has exceeded a threshold.

Graphic Symbol	Description
	High-High threshold exceeded

Graphic Symbol	Description
	High threshold exceeded
	Low threshold exceeded
	Low-Low threshold exceeded
	High deviation threshold exceeded.
	Low deviation threshold exceeded.
	High rate of change threshold exceeded.

Mode Indicators







One of these symbols appears on the right side of the graphic symbol to indicate the mode of the object instruction.

Graphic Symbol	Description
Transparent	Operator mode (if the default mode is Operator and the current mode is Operator, the mode indicator is transparent).
	Operator mode (if the default mode is Program).
	Operator mode locked.
Transparent	Program mode (if the default mode is Program and the current mode is Program, the mode indicator is transparent).
	Program mode (if the default mode is Operator).
	Program mode locked.
	Maintenance mode.
	No mode.

See Rockwell Automation Library of Process Objects: Common Mode Block (P_Mode) Reference Manual, publication [SYSLIB-RM005](#), for more information.

Alarm Indicators

One of these symbols appears on the left of the label to indicate the described alarm condition. The alarm border and label background blink if Acknowledgement of an alarm condition is required. Once the alarm is acknowledged, the alarm border and label background remain the color that corresponds to the severity of the alarm.

Symbol	Border and Label Background	Description
	No change in color	Alarm Inhibit: an alarm is suppressed by the Program, disabled by Maintenance, or shelved by the Operator.
	White	Return to normal (no alarm condition), but a previous alarm has not been acknowledged.
	Blue	Low severity alarm.
	Yellow	Medium severity alarm.
	Red	High severity alarm.
	Magenta	Urgent severity alarm.
No symbol	No change in color	No alarm or alarm inhibit condition, and all alarms are acknowledged.

See Rockwell Automation Library of Process Objects: Common Alarm Block (P_Alarm) Reference Manual, publication [SYSLIB-RM002](#), for more information.

Maintenance Bypass Indicator

This symbol appears to the right of the label to indicate that a maintenance bypass has been activated.

Graphic Symbol	Description
	A maintenance bypass is active.
No symbol displayed	No maintenance bypass is active.

TIP When the Maintenance Bypass indicator appears, you can find what condition was bypassed by following the indicators. Click the graphic symbol to open the faceplate. The Maintenance Bypass indicator appears next to the appropriate tab at the top of the faceplate to guide you in finding the bypass. Once you navigate to the tab, the bypassed item is flagged with this indicator.

For the Advanced Analog Input Instruction, the Maintenance Bypass Indicator appears when the Substitute PV function has been enabled. The 'live' Process Variable is being superseded by a Maintenance-entered value.

Using Display Elements

The display elements for P_InAdv can be found in the global object file (RA-BAS) P_In Graphics Library.ggfx. Follow these steps to use a global object.

1. Copy the global object from the global object file and paste it in the display file.

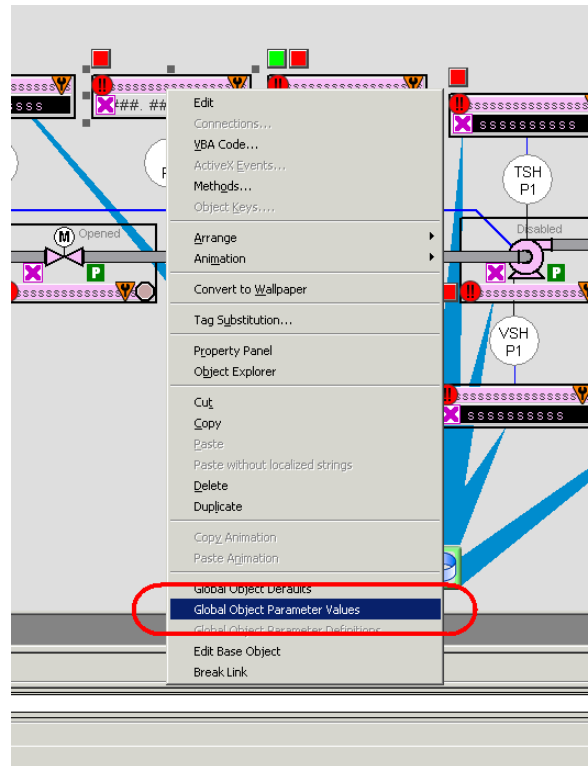

2. In the display, right-click the global object and choose Global Object Parameter Values.

The Global Object Parameter Values dialog box appears.

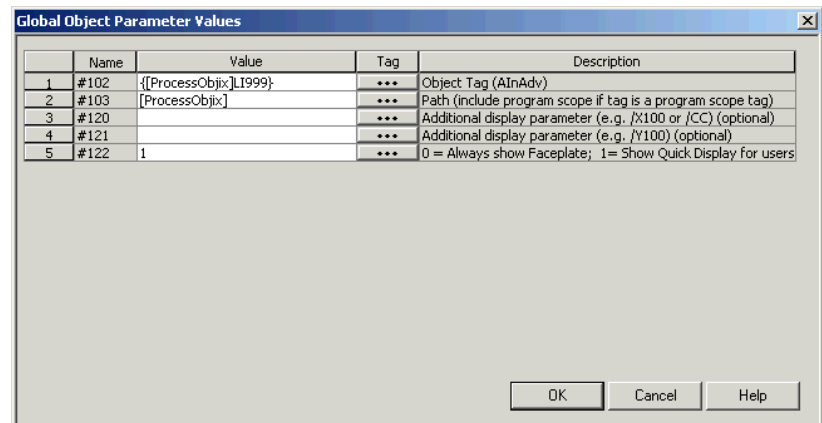

The global object parameters are as follows.

Parameter	Required	Description
#102	Y	Object tag to point to the name of the associated object Add-On Instruction in the controller.
#103	Y	Path used for display navigation features to other objects. Include program scope if tag is a program scope tag.
#120	N	Additional parameter to pass to the display command to open the faceplate. Typically used to define position for the faceplate.
#121	N	Additional parameter to pass to the display command to open the faceplate. if defining X and Y coordinate, separate parameters so that X is defined by #120 and Y is defined by #121. This lets these same parameters to be used in subsequent display commands originating from the faceplate.
#122	Y	These are the options for the global object display: 0 = Always show faceplate 1 = Show Quick Display for users without Maintenance access (Code C) 2 = Always show Quick Display

- In the Value column, type the tag or value as specified in the Description column.

TIP Click the ellipsis (. . .) to browse and select a tag.
Values for items marked '(optional)' can be left blank.

- Click OK.

Quick Display

The Quick Display screen provides means for operators to perform simple interactions with the P_AInAdv instruction instance. From the Quick Display, you can navigate to the faceplate for full access for operation, maintenance, and configuration.

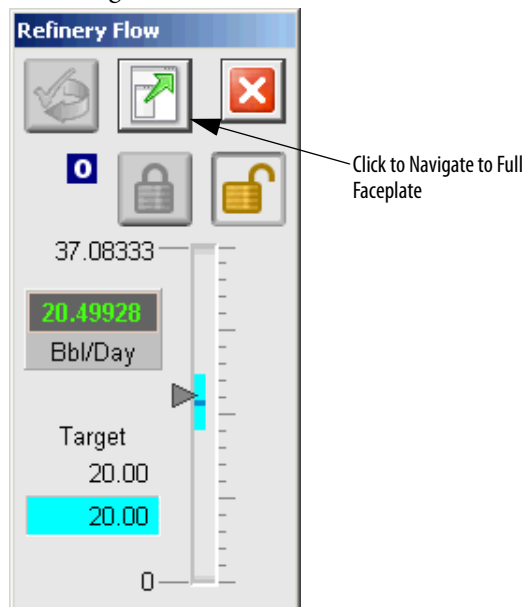

Faceplate

The P_AInAdv faceplate consists of five tabs and each tab consists of one or more pages.

Each faceplate contains the value of local configuration tags Cfg_Tag and Cfg_Desc in the title bar.

Tag - Description

The Operator tab is displayed when the faceplate is initially opened. Click the appropriate icon at the top of the faceplate to access a specific tab.

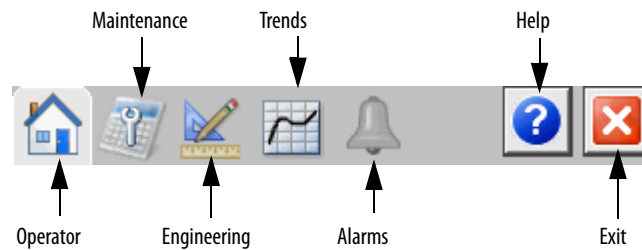

The faceplate provides the means for operators, maintenance workers, engineers, and others to interact with the P_AInAdv instruction instance, including viewing its status and values and manipulating it through its commands and settings.

When a given input is restricted via FactoryTalk View security, the required user security code letter is shown in the tables that follow.

Operator Tab

The Faceplate initially opens to the Operator ('Home') tab. From here, an operator can monitor the device status and manually operate the device when it is in Operator mode.

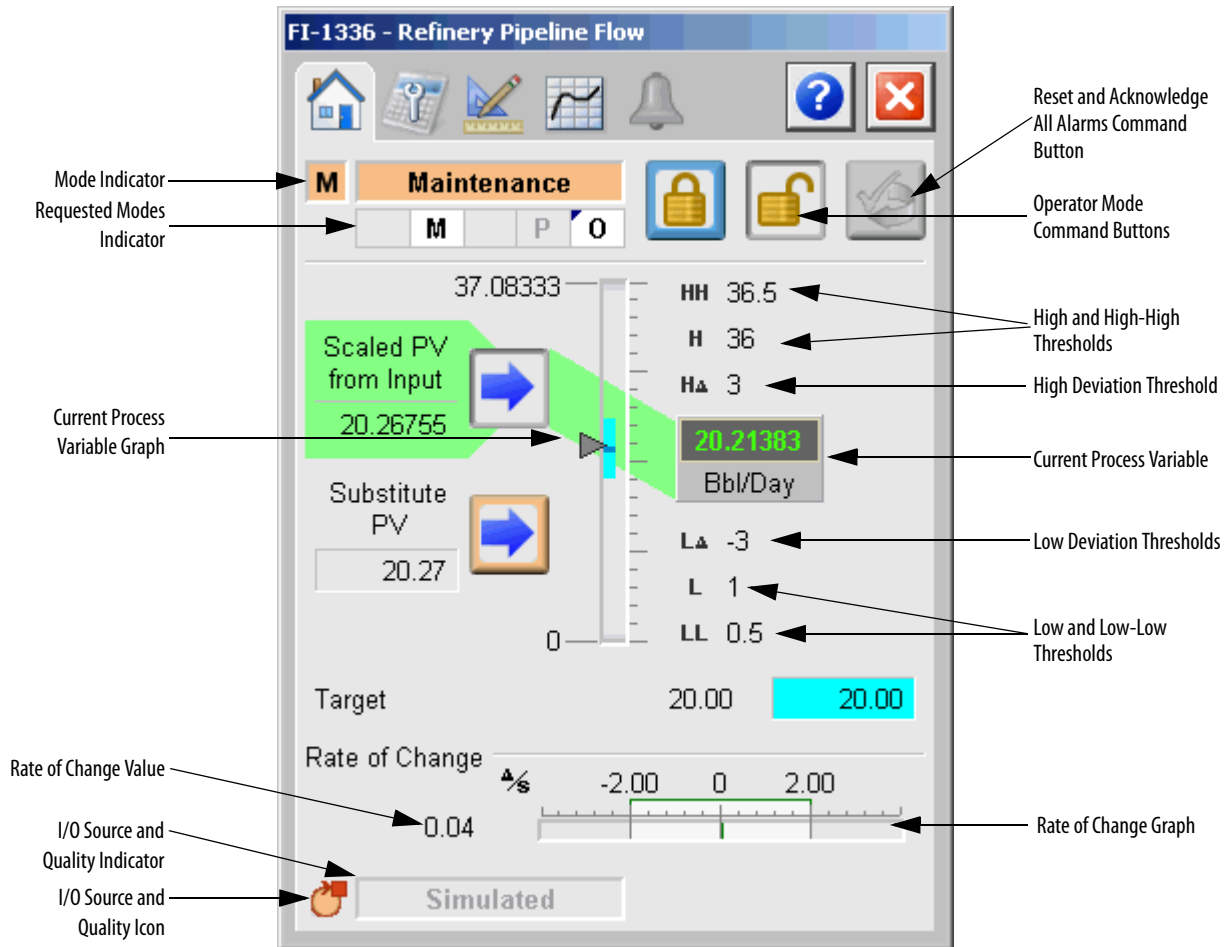







The Operator tab shows the following information:

- Current mode (Program, Operator, or Maintenance).
- Requested modes indicator (appears only if the Operator or Program mode has been superseded by another mode.)
- Current PV.
- Bar graph for the current PV. High-High and Low-Low ranges are shown in dark gray and these ranges turn red if the threshold is exceeded. High and Low ranges are shown in medium gray and these ranges turn yellow if the threshold is exceeded.
- Scaled high and low range values (top and bottom labels on the bar graph). If High-range or Low-range values are exceeded, then the appropriate icon appears next to the values to the left of the bar graph.
- High-High (HH) and Low-Low (LL) thresholds are displayed with a label background that turns red when exceeded.

- High (H) and Low (L) thresholds are displayed with a label background that turns yellow when exceeded.
- High Deviation (HΔ) and Low Deviation (LΔ) limits are displayed with a label background that turns yellow when exceeded.
- The current rate of change value and a bar graph are visible if Rate of Change calculations are enabled (configured on the Engineering tab).
- Input Source and Quality indicator (See 'SrcQ' in the Output parameters table on [page 20](#) for details).
- If the device is in Maintenance mode or the Substitute Process Variable is selected, then the Input Process Variable, Substitute Value, and buttons for selecting either one are displayed, along with a colored arrow indicating which is in use.
- If the device is in simulation (Inp_Sim = 1), then a data entry field for the simulated PV is displayed.







The following table shows the functions included on the Operator tab.

Table 11 - Operator Tab Description

Function	Action	Security
	Click to lock in Operator mode. Function locks the mode in Operator mode, preventing the program from taking control.	Manual Device Operation (Code B)
	Click to unlock Operator mode. Function unlocks Operator mode, letting the program to take control.	
	Click to request Program mode.	
	Click to request Operator mode.	
	Click to reset and acknowledge all alarms.	Acknowledge Alarms (Code F)
	Click to select normal input for the PV. This button is visible only in Maintenance mode, and only if Engineering has enabled the Substitute PV function.	Equipment Maintenance (Code C)
	Click to select substitute PV instead of normal input. This button is visible only in Maintenance mode, and only if engineering has enabled the substitute PV function.	
Substitute PV data entry	Type the substitute PV value. This entry is available only when the substitute PV function is enabled.	
PV Used in simulation data entry (not shown on faceplate image)	Type the simulation PV value. This entry is available only when input simulation is enabled. (See Simulation on page 26 for more information.)	Normal Operation of Devices (Code A)

The following table shows the alarm status symbols used on the Operator tab.

Table 12 - Operator Tab Alarm Status

Graphic Symbol	Alarm Status
	In Alarm (Active Alarm)
	In Alarm and Acknowledged
	Out of Alarm but not Acknowledged
	Alarm Suppressed (by Program Logic)
	Alarm Disabled (by Maintenance)
	Alarm Shelved (by Operator)

Alarm indicators appear on the Operator tab when the corresponding alarm occurs.

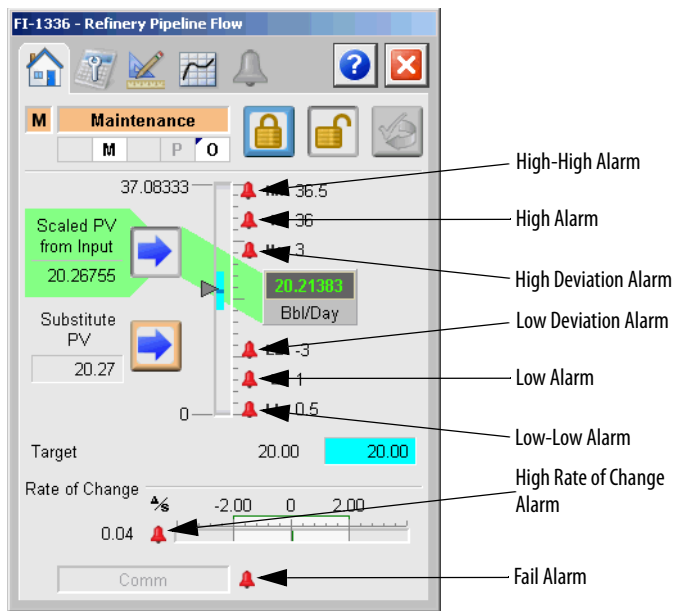

Maintenance Tab

Maintenance personnel use the information and controls on the Maintenance tab to make adjustments to device parameters, troubleshoot and temporarily work around device problems.

The Maintenance tab shows the following information:

- Current mode (Program, Operator, or Maintenance).
- Requested modes indicator - highlights all of the modes that have been requested. The leftmost highlighted mode is the active mode.

The screenshot displays the Maintenance tab for FI-1336 - Refinery Pipeline Flow. The interface includes a mode indicator 'M' for Maintenance, a requested mode indicator with 'M', 'P', and 'O' buttons, and a 'Raw Input' of 30.87402. A table lists various status thresholds and deadbands. A green checkmark indicates 'Bumpless Program/Operator Transition'.



Threshold Name	Threshold (Bbl/Day)	Deadband (Bbl/Day)
PV Fail Status	37.60	0.10
PV High-High	-0.50	0.50
PV High Status	36.00	0.50
PV Low Status	1.00	0.50
PV Lo-Lo Status	0.50	0.50
PV Hi Dev Status	3.00	0.20
PV Lo Dev Status	-3.00	0.20
PV Hi Rate of Change	2.00	0.20

Annotations in the image include:

- Mode Indicator: Points to the 'M' icon.
- Requested Mode Indicator: Points to the 'M', 'P', and 'O' buttons.
- Maintenance Mode Acquire and Release Command Buttons: Points to the wrench and screwdriver icons.
- Threshold Name: Points to the first column of the table.
- Status thresholds and Deadbands: Points to the table.

The following table shows the functions on the Maintenance tab.

Table 13 - Maintenance Tab Description

Function	Action	Security	Configuration Parameters
	Click for Maintenance mode.	Equipment Maintenance (Code C)	None
	Click to release Maintenance mode.		
Raw Input	Click raw input to open the associated upstream channel object faceplate. 'Enable navigation to the input channel object' must be checked. (See Engineering Tab Page 1 on page 41.)	None	
Threshold	Type the threshold (trip point) for analog input alarms.	Disable Alarms Bypass Permissives and Interlocks (Code H)	<ul style="list-style-type: none"> • Cfg_FailHiLim • Cfg_FailLoLim
Deadband	Type the deadband (hysteresis) that is applied to each alarm limit. This is used to prevent a noisy signal from generating numerous spurious alarms. Example: If the High alarm limit is 90.0 and the High alarm deadband is 5, once the signal rises above 90.0 and generates a High alarm, the signal must fall below 85.0 (90.0-5.0) for the alarm to clear.		<ul style="list-style-type: none"> • Cfg_HiHiDB • Cfg_HiDB • Cfg_LoDB • Cfg_LoLoDB • Cfg_FailDB • Cfg_HiRoCDB • Cfg_HiDevDB • Cfg_LoDevDB
Threshold Name	Click a threshold name to open the associated P_Gate faceplate.	Normal Operation of Devices (Code A)	Cfg_InpCond of P_Gate
Bumpless Program/Operator Transition	Check so that when this parameter is: <ul style="list-style-type: none"> • On, the operator settings track the program settings when mode is Program, and program settings track the operator settings when the mode is Operator. Transition between modes is bumpless. • Off, the operator settings and program settings are not modified by this instruction and retain their values regardless of mode. When the mode is changed, the value of a limit can change, such as from the Program-set value to the Operator-set value. 	Equipment Maintenance (Code C)	Cfg_SetTrack

Refer to the Rockwell Automation Library of Process Objects: Condition Gate Delay (P_Gate) Reference Manual, publication [SYSLIB-RM041](#), for more information.

Refer to the Rockwell Automation Library of Process Objects: Analog Input Channel (P_AIChan) Reference Manual, publication [SYSLIB-RM042](#), for more information.

Engineering Tab

The Engineering tab provides access to device configuration parameters and ranges, options for device and I/O setup, displayed text, and faceplate-to-faceplate navigation settings, for initial system commissioning or later system changes.

The engineering tab is divided into two pages.

Engineering Tab Page 1

On page 1 of the Engineering tab, you can configure the description, label, and tag text; you can also define scaling factors and units text for the device and advanced options.

The screenshot shows the configuration window for 'FI-1336 - Refinery Pipeline Flow'. The window title bar includes a home icon, a calculator icon, a pencil icon, a graph icon, a bell icon, a help icon, and a close icon. Below the title bar are two tabs labeled '1' and '2', and a 'Mode Configuration Button' with 'O', 'P', and 'M' indicators. The main configuration area is divided into sections:

- Device Information:** Description: 'Refinery Pipeline Flow', Label: 'Refinery Flow', Tag: 'FI-1336'. This section is annotated as 'Configure Device Description, Label, and Tag'.
- Raw Input Scaling:** A table with columns 'Input' and 'Scaled'.

	Input	Function	Scaled
Maximum	100.00	$f(x)$	37.08
Minimum	0.00		0.00

 Below the table is a 'Units' field set to 'Bbl/Day'. This section is annotated as 'Configure Input and Scaled Ranges and Engineering Units Text'.
- Advanced Options:** Three checkboxes:
 - Enable navigation to the input channel object
 - Allow selection of Substitute PV
 - Clear Program Commands upon receipt

The following table lists the functions on page 1 of the Engineering tab.

Table 14 - Engineering Tab Page 1 Description

Function	Action	Security	Configuration Parameters
	Click to open the Mode Configuration display.	Engineering Configuration (Code E)	See Mode Configuration display on page 43
Description	Type the device description to show on the faceplate title bar.		Cfg_Desc
Label	Type the label to show on the graphic symbol.		Cfg_Label
Tag	Type the tag name to show on the faceplate and Tooltip. IMPORTANT: Pausing the mouse over this field displays a tool tip with the configured Logix tag/path.		Cfg_Tag
Maximum Value for the Input Variable	Type the maximum value for the Input Process Variable (unscaled).		<ul style="list-style-type: none"> Cfg_InpRawMax Cfg_InpRawMin
Minimum Value for the Input Variable	Type the minimum value for the Input Process Variable (unscaled).		
Maximum for the Scaled Value	Type the maximum for the Scaled Process Variable (displayed).		<ul style="list-style-type: none"> Cfg_PVEUMax Cfg_PVEUMin
Minimum for the Scaled Value	Type the minimum for the Scaled Process Variable (displayed).		
Units	Type the engineering units for display on the HMI.		Cfg_EU
Enable navigation to the input channel object	Check to enable navigation to an upstream channel object (for example, P_AIChan). IMPORTANT: The name of the Channel object in the controller must be this object's name with the suffix '_Chan'. For example, if your P_AlnAdv object has the name 'AlnAdv123', then its Channel object must be named 'AlnAdv123_Chan'.		Cfg_HasChanObj
Allow selection of Substitute PV	Check to allow the Substitute PV Maintenance function. Clear this checkbox to disallow the Substitute PV Maintenance function (default).		Cfg_NoSubstPV
Clear Program Commands on Receipt	Check to clear Program commands on receipt.		Cfg_PCmdClear

Mode Configuration Display

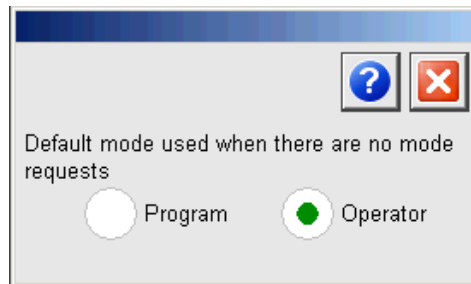

This display lets you select the default mode for the object by clicking the appropriate mode.

IMPORTANT If no mode is being requested, changing the default mode changes the mode of the instruction.

You must have FactoryTalk View security code E to select the default mode on this display.

Engineering Tab Page 2

On page 2 of the Engineering tab, you can configure additional options, plus the PV first-order filter time constant, and the time base for rate of change calculations.

FI-1336 - Refinery Pipeline Flow

1 2

- Use Square Root characterization for DP to flow
- Enable Target entry, Deviation calculations, display, and alarms
- Enable Rate of Change calculations, display, and alarm

PV Filter Time Constant (sec)

0 = unfiltered

PV Rate of Change time base (sec)

(e.g. , 60=/min, 3600=/hr)

Process Variable Filter Time

Process Variable Rate of Change Time

The following table shows the functions on page 2 of the Engineering tab.

Table 15 - Engineering Tab Page 2 Description

Function	Action	Security	Configuration Parameters
Use Square Root characterization for DP to Flow	Check to use the square root characterization for a differential pressure input to read flow. Clear this checkbox (default) to use linear scaling.	Engineering Configuration (Code E)	Cfg_UseSqrt
Enable target entry, deviation calculations, display, and alarms	Check to enable target entry, deviation calculations, display, and alarms.		Cfg_HasDev
Enable Rate of Change calculations, display, and alarms	Check to enable Rate of Change calculations, display, and alarms.		Cfg_Has RoC
PV Filter Time Constant	Type the time in seconds for the process variable filter time constant.		Cfg_Has RoC
PV Rate of Change time base	If the PV (in engineering units, EU) Rate of Change is to be reported in the following: EU/second: enter 1.0 EU/minute: enter 60.0 EU/hour: enter 3600.0		Cfg_RateTime

Trends Tab

The Trends tab shows trend charts of key device data over time. These faceplate trends provide a quick view of current device performance to supplement, but not replace, dedicated historical, or live trend displays.

The Trends tab is divided into two pages.

Trends Tab Page 1

Page 1 of the Trends tab displays the trend that charts the Process Variable and the PV Target values.

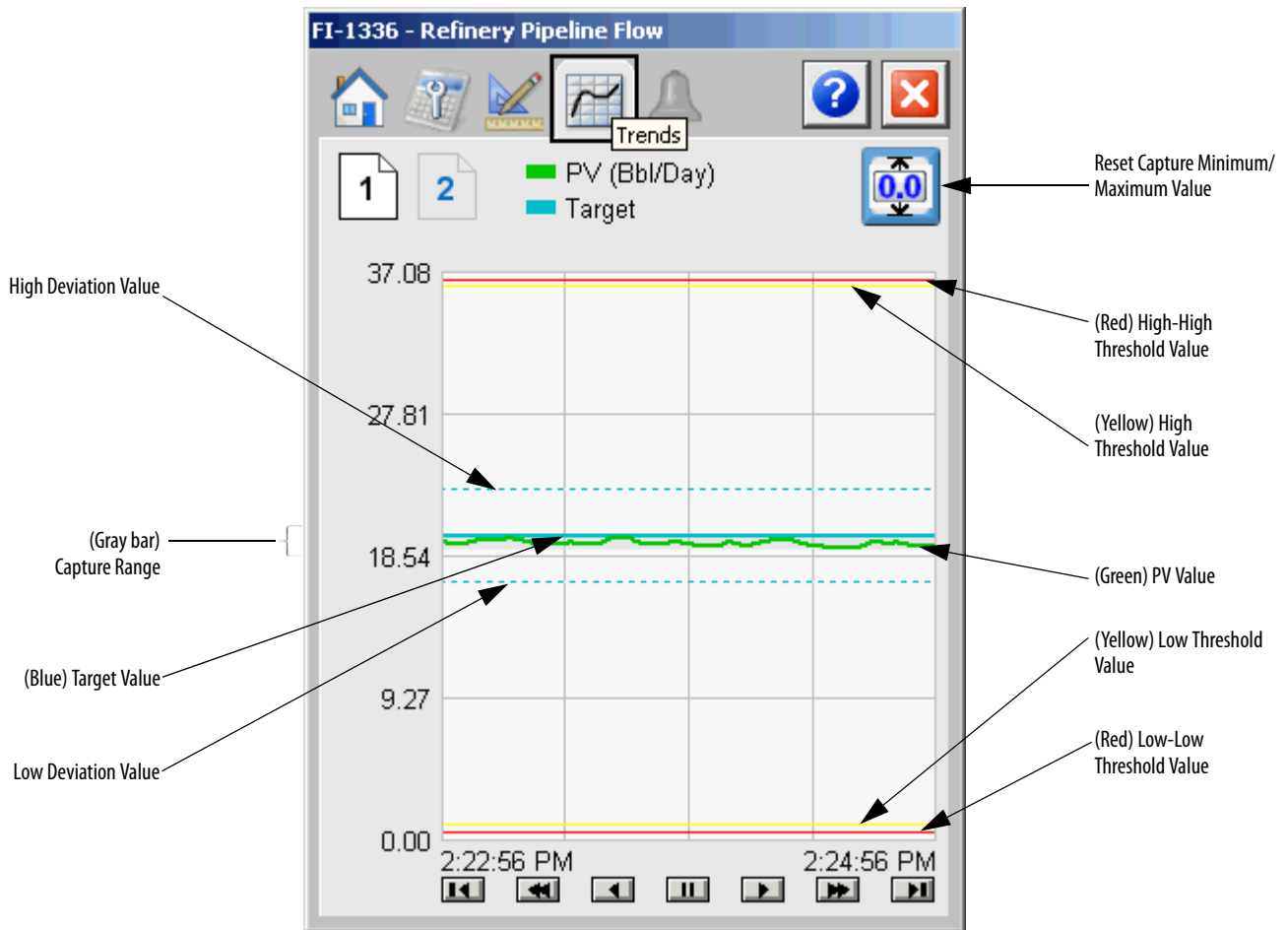

The following table lists the functions on page 1 of the Trends tab.

Table 16 - Trends Tab Page 1 Description

Function	Action	Security Required
	Reset capture minimum/maximum values	Normal Operation of Devices (Code A)

You can reset the capture range's minimum/maximum values. The green line represents the Process Variable (PV) and the light gray area shows the capture range. The thin cyan line shows the target while the thick cyan lines show the High and Low deviation from the target.

Trends Tab Page 2

Page 2 of the Trends tab charts the PV Rate of Change and Rate of Change Threshold values.

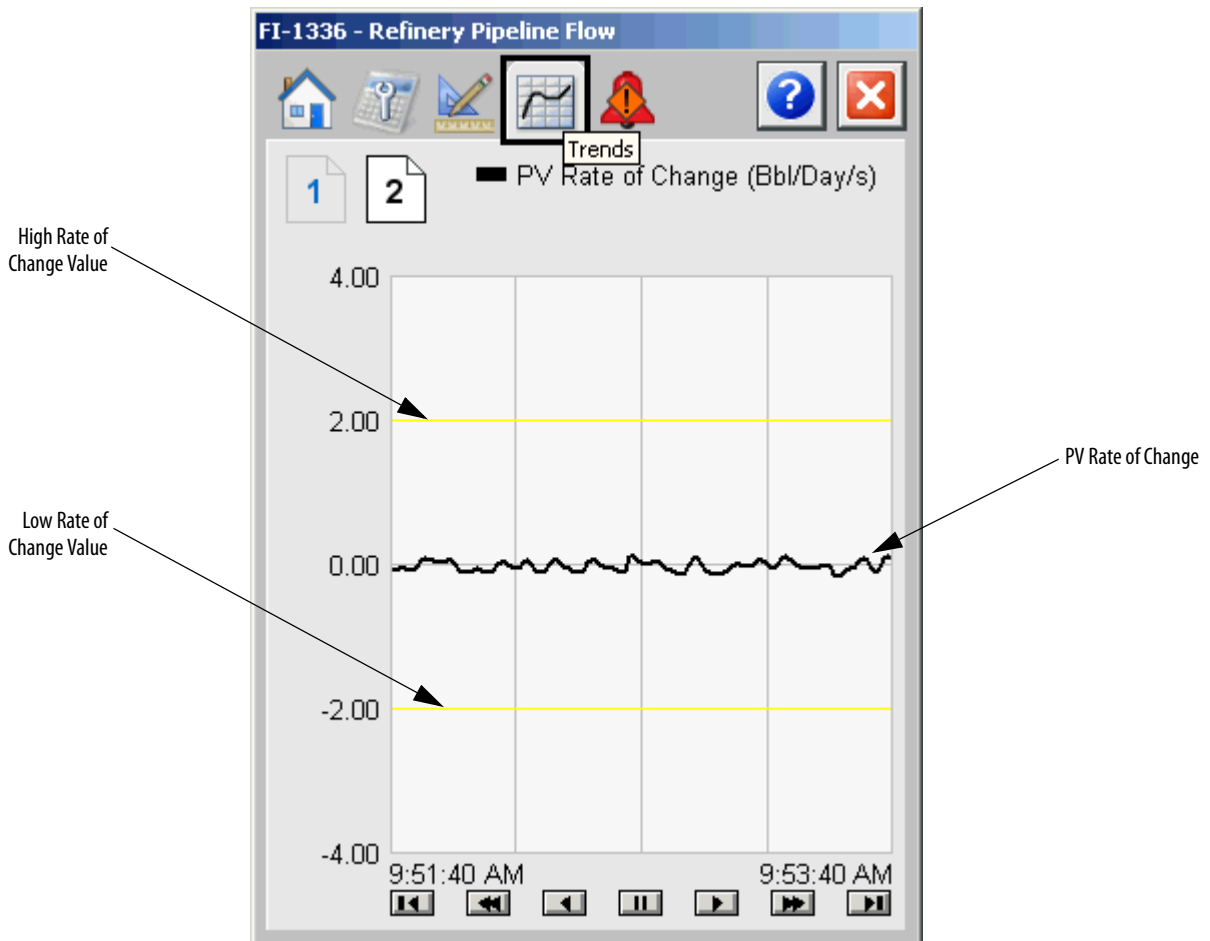

Alarms Tab

The Alarms tab displays each configured alarm for the P_AlnAdv instruction. The icon on the tab for the alarms page changes color based on the current active alarms. A blinking alarm icon indicates that one or more alarms must be acknowledged or the device must be reset.

Alarms Tab

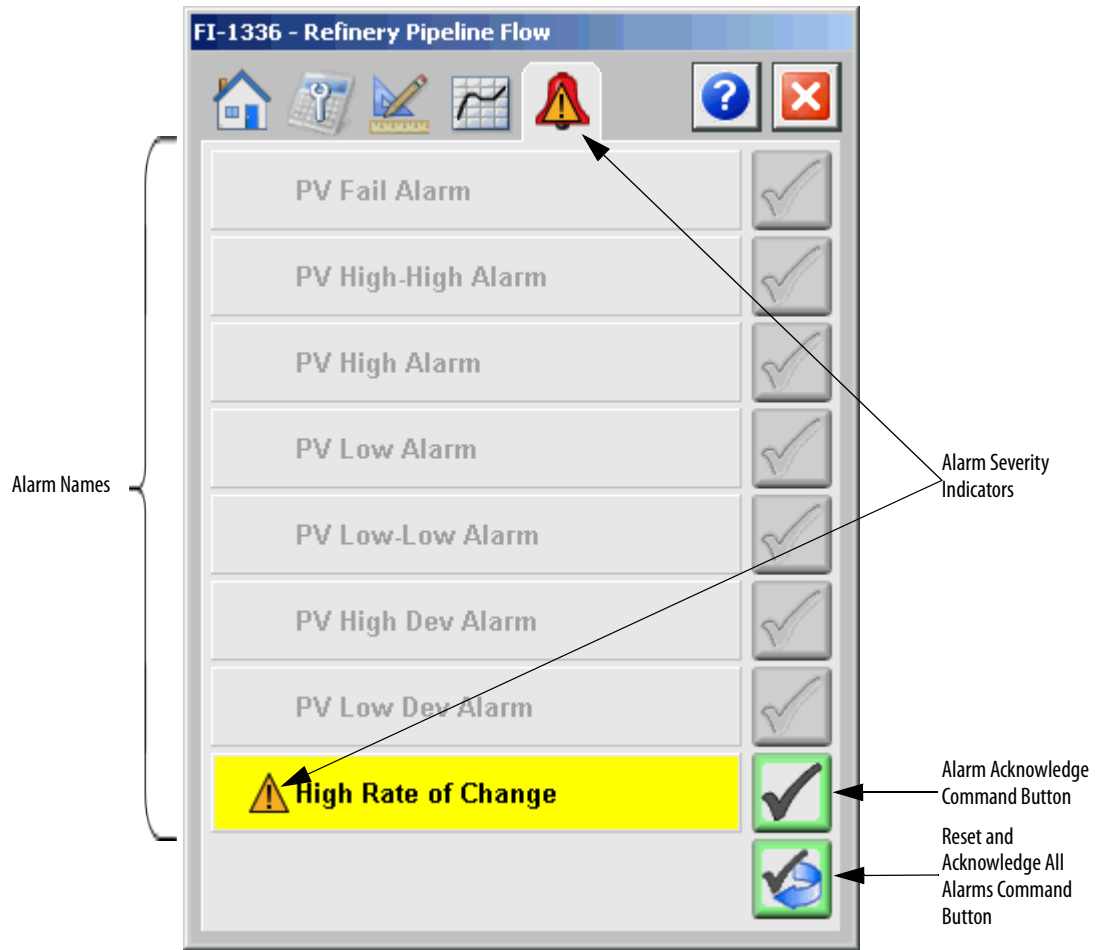

Click an alarm name to open the P_Alarm faceplate for that alarm. From the P_Alarm faceplate, you can configure and perform additional operations on the alarm.



If an alarm is active, the panel behind the alarm changes color to match the severity of the alarm. The color of the bell icon at the top of the faceplate shows the severity of the highest active alarm, and the icon blinks if any alarm is unacknowledged or requires reset.

Table 17 - Alarm Severity Colors

Color	Definition
Magenta	Urgent
Red	High
Yellow	Medium
Blue	Low
White (bell icon)	Alarm has cleared but is unacknowledged
Background (Light Gray)	No alarm

The following table shows the functions on the Alarms tab.

Table 18 - Alarms Tab Description

Function	Action	Security
Alarm Name	Click an alarm name to open the associated P_Alarm faceplate.	None
	Click to acknowledge the alarm.	Acknowledge Alarms (Code F)
	Click to reset and acknowledge all alarms.	

When the Reset and Acknowledge All Alarms button is enabled, the panel behind the alarm blinks, indicating the alarm requires acknowledgement or reset. The Alarm Acknowledge button is enabled if the alarm requires acknowledgment. Click the button with the check mark to acknowledge the alarm.

See Rockwell Automation Library of Process Objects: Common Alarm Block (P_Alarm) Reference Manual, publication [SYSLIB-RM002](#), for more information.

Advanced Analog Input Faceplate Help

The Faceplate Help is divided into two pages.

Faceplate Help Page 1

Advanced Analog Input Faceplate Help

1 2

Status Indicators

- Invalid Configuration
- Communication Failure
- Communication Uncertain
- Input has been Disabled
- Alarm Inhibit (Suppressed or Disabled)
- A Maintenance Bypass is Active
- Device in Simulation or Test

Level Indicators

- High-High Level Exceeded
- High Level Exceeded
- High Deviation Exceeded
- High Rate of Change Exceeded
- Low-Low Level Exceeded
- Low Level Exceeded
- Low Deviation Exceeded

Mode Indicators

- Device in Program Mode
- Device in Maintenance Mode
- Device in Operator Mode
- No Mode (Out of Service)

Commands

- Operator Command to Reset Minimum and Maximum capture values.

Faceplate Help Page 2

Advanced Analog Input Faceplate Help

1 2

Alarms

Device Fail Alarm

This alarm triggers when the Scaled Process Value remains above the Out of Range High limit or below the Out of Range Low limit for a specified period of time. The Alarm also triggers when the input PV signal quality is bad.

Level Alarms (High-High, High, Low, and Low-Low)

These alarms trigger when the Scaled Process Value has remained above (for High and High-High) or below (for Low and Low-Low) the specified limit for a specified period of time

Deviation Alarms (High Deviation and Low Deviation)

These alarms trigger when the difference between the Scaled Process Value and the Target Value is remains greater than the High Deviation Limit or less than the Low Deviation Limit for a specified period of time.

Rate of Change Alarm

The Rate of Change Alarm Triggers when the calculated rate of change remains greater than the specified limit for the specified period of time.

Bumpless Program/Operator Transition

When checked, Substitute PV and Threshold Limits will track their corresponding program values in Program Mode. Also, Program Threshold Limits will track Operator entered values in Operator or Maintenance Mode. When not checked, program and operator values can be changed independently.

Rockwell Automation Support

Rockwell Automation provides technical information on the Web to assist you in using its products.

At <http://www.rockwellautomation.com/support> you can find technical and application notes, sample code, and links to software service packs. You can also visit our Support Center at <https://rockwellautomation.custhelp.com/> for software updates, support chats and forums, technical information, FAQs, and to sign up for product notification updates.

In addition, we offer multiple support programs for installation, configuration, and troubleshooting. For more information, contact your local distributor or Rockwell Automation representative, or visit <http://www.rockwellautomation.com/services/online-phone>.

Installation Assistance

If you experience a problem within the first 24 hours of installation, review the information that is contained in this manual. You can contact Customer Support for initial help in getting your product up and running.

United States or Canada	1.440.646.3434
Outside United States or Canada	Use the Worldwide Locator at http://www.rockwellautomation.com/rockwellautomation/support/overview.page , or contact your local Rockwell Automation representative.

New Product Satisfaction Return

Rockwell Automation tests all of its products to help ensure that they are fully operational when shipped from the manufacturing facility. However, if your product is not functioning and needs to be returned, follow these procedures.

United States	Contact your distributor. You must provide a Customer Support case number (call the phone number above to obtain one) to your distributor to complete the return process.
Outside United States	Please contact your local Rockwell Automation representative for the return procedure.

Documentation Feedback

Your comments will help us serve your documentation needs better. If you have any suggestions on how to improve this document, complete this form, publication [RA-DU002](#), available at <http://www.rockwellautomation.com/literature/>.

Rockwell Automation maintains current product environmental information on its website at <http://www.rockwellautomation.com/rockwellautomation/about-us/sustainability-ethics/product-environmental-compliance.page>.

Rockwell Otomasyon Ticaret A.Ş., Kar Plaza İş Merkezi E Blok Kat:6 34752 İçerenköy, İstanbul, Tel: +90 (216) 5698400

www.rockwellautomation.com

Power, Control and Information Solutions Headquarters

Americas: Rockwell Automation, 1201 South Second Street, Milwaukee, WI 53204-2496 USA, Tel: (1) 414.382.2000, Fax: (1) 414.382.4444
Europe/Middle East/Africa: Rockwell Automation NV, Pegasus Park, De Kleetlaan 12a, 1831 Diegem, Belgium, Tel: (32) 2 663 0600, Fax: (32) 2 663 0640
Asia Pacific: Rockwell Automation, Level 14, Core F, Cyberport 3, 100 Cyberport Road, Hong Kong, Tel: (852) 2887 4788, Fax: (852) 2508 1846

Publication SYSLIB-RM018F-EN-E - January 2016

Supersedes Publication SYSLIB-RM018E-EN-E - August 2014

Copyright © 2016 Rockwell Automation, Inc. All rights reserved. Printed in the U.S.A.