

Rockwell Automation Library of Process Objects: Discrete Input Object (P_DIn)

Version 3.5

IMPORTANT

This manual applies to the Rockwell Automation Library of Process Objects version 3.5 or earlier.
For Rockwell Automation Library of Process Objects version 5.0, see

- [PROCES-RM200](#)

For Rockwell Automation Library of Process Objects version 4.0 or later, use the following manuals:

- [PROCES-RM013](#) contains logic instructions
- [PROCES-RM014](#) contains display elements



Important User Information

Read this document and the documents listed in the additional resources section about installation, configuration, and operation of this equipment before you install, configure, operate, or maintain this product. Users are required to familiarize themselves with installation and wiring instructions in addition to requirements of all applicable codes, laws, and standards.

Activities including installation, adjustments, putting into service, use, assembly, disassembly, and maintenance are required to be carried out by suitably trained personnel in accordance with applicable code of practice.

If this equipment is used in a manner not specified by the manufacturer, the protection provided by the equipment may be impaired.

In no event will Rockwell Automation, Inc. be responsible or liable for indirect or consequential damages resulting from the use or application of this equipment.

The examples and diagrams in this manual are included solely for illustrative purposes. Because of the many variables and requirements associated with any particular installation, Rockwell Automation, Inc. cannot assume responsibility or liability for actual use based on the examples and diagrams.

No patent liability is assumed by Rockwell Automation, Inc. with respect to use of information, circuits, equipment, or software described in this manual.

Reproduction of the contents of this manual, in whole or in part, without written permission of Rockwell Automation, Inc., is prohibited.

Throughout this manual, when necessary, we use notes to make you aware of safety considerations.



WARNING: Identifies information about practices or circumstances that can cause an explosion in a hazardous environment, which may lead to personal injury or death, property damage, or economic loss.



ATTENTION: Identifies information about practices or circumstances that can lead to personal injury or death, property damage, or economic loss. Attentions help you identify a hazard, avoid a hazard, and recognize the consequence.

IMPORTANT

Identifies information that is critical for successful application and understanding of the product.

Labels may also be on or inside the equipment to provide specific precautions.



SHOCK HAZARD: Labels may be on or inside the equipment, for example, a drive or motor, to alert people that dangerous voltage may be present.



BURN HAZARD: Labels may be on or inside the equipment, for example, a drive or motor, to alert people that surfaces may reach dangerous temperatures.



ARC FLASH HAZARD: Labels may be on or inside the equipment, for example, a motor control center, to alert people to potential Arc Flash. Arc Flash will cause severe injury or death. Wear proper Personal Protective Equipment (PPE). Follow ALL Regulatory requirements for safe work practices and for Personal Protective Equipment (PPE).

Preface	Software Compatibility and Content Revision.....	5
	Additional Resources.....	6
Discrete Input (P_DIn)	Guidelines.....	7
	Functional Description.....	8
	Required Files.....	9
	Controller File.....	9
	Visualization Files.....	9
	Controller Code.....	11
	Input Structure for Discrete Input.....	11
	Output Structure for Discrete Input.....	13
	Local Configuration Tags for Discrete Input.....	15
	Operations.....	16
	Modes.....	16
	Alarms.....	16
	Simulation.....	17
	Execution.....	17
	Implementation by Using the EnableIn False Feature.....	18
	Programming Example.....	19
	Display Elements.....	19
	Status/Quality Indicators.....	20
	Alarm Indicators.....	21
	Maintenance Bypass Indicator.....	22
	Using Display Elements.....	22
	Faceplate.....	24
	Operator Tab.....	25
	Maintenance Tab.....	28
	Engineering Tab.....	30
	Alarms Tab.....	32
	Discrete Input - Faceplate Help.....	34

Notes:

This manual contains new and updated information. Changes throughout this revision are marked by change bars, as shown to the right of this paragraph.

Software Compatibility and Content Revision

Table 1 - Summary of Changes

Topic	Page
Changed software version from 3_1 to 3_5	9
Split visualization files table by type and reordered to align with installation requirements	9
Updated Alarm descriptions	16
Updated Status/Quality Indicator descriptions	20

For the latest compatible software information and to download the Rockwell Automation® Library of Process Objects, see the Product Compatibility and Download Center at <http://www.rockwellautomation.com/rockwellautomation/support/pcdc.page>.

For general library considerations, see Rockwell Automation Library of Process Objects, publication [PROCES-RM002](#).

Additional Resources

These documents contain additional information concerning related products from Rockwell Automation.

Resource	Description
PlantPAx® Distributed Control System Selection Guide, publication PROCES-SG001	Provides information to assist with equipment procurement for your PlantPAx system.
PlantPAx Distributed Control System Reference Manual, publication PROCES-RM001	Provides characterized recommendations for implementing your PlantPAx system.
Rockwell Automation Library of Process Objects, publication PROCES-RM002	Provides general considerations for the PlantPAx system library of process objects.
FactoryTalk® View Machine Edition User Manual, publication VIEWME-UM004	Provides details on how to use this software package for creating an automation application.
FactoryTalk View Site Edition User Manual, publication VIEWSE-UM006	Provides details on how to use this software package for developing and running human-machine interface (HMI) applications that can involve multiple users and servers, distributed over a network.
Logix5000™ Controllers Add-On Instructions Programming Manual, publication 1756-PM010	Provides information for designing, configuring, and programming Add-On Instructions.
Rockwell Automation Library of Process Objects: Common Alarm Block (P_Alarm) Reference Manual, publication SYSLIB-RM002	Details how to monitor an input condition to raise an alarm. Information includes acknowledging, resetting, inhibiting, and disabling an alarm. Generally the P_Alarm faceplate is accessible from the Alarms tab.
Rockwell Automation Library of Process Objects: Condition Gate Delay (P_Gate) Reference Manual, publication SYSLIB-RM041	Provides details for using the P_Gate instruction for processing status and alarm conditions, including gate delay, on-delay, and off-delay timing. Generally the P_Gate faceplate is accessible from the Maintenance tab.

You can view or download publications at <http://www.rockwellautomation.com/literature/>. To order paper copies of technical documentation, contact your local Allen-Bradley distributor or Rockwell Automation sales representative.

Discrete Input (P_DIn)

The P_DIn (Discrete Input) Add-On Instruction is used to receive and process a single discrete condition (the Process Variable or PV), typically for a channel of a discrete input card. It can be used with any discrete (BOOL) signal. The global object and faceplate shown below are examples of the graphical interface tools for this Add-On Instruction.

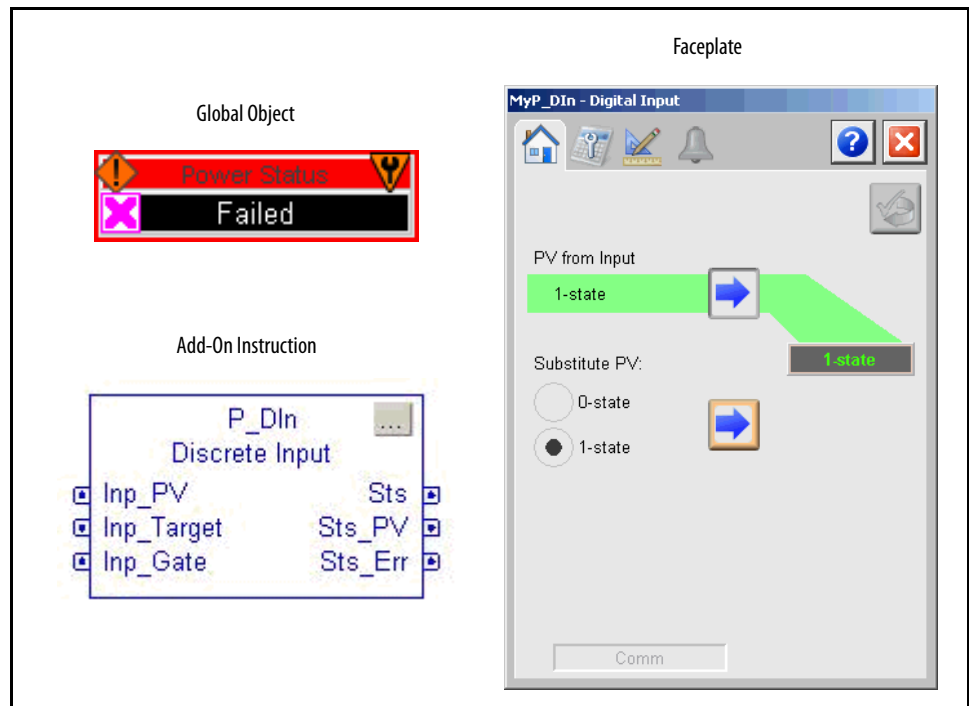

Guidelines

Use this instruction in these situations:

- You want to display the state of a process temperature, level, flow, proximity, pressure, or other switch.
- You need any of these signal processing or alarming features for a Discrete input or any Discrete (bit) value:
 - De-bounce of the discrete input signal.
 - Target Disagree status and optional alarm when the Discrete input is not in a Target state for some period of time and a gating condition is true for some period of time.
 - Display of the input state with configurable text on an HMI object.
 - Ability for maintenance personnel to provide a substitute value when the device has failed.

Do **not** use this instruction in these situations:

- You need only to show or not show the state of a bit on an HMI display. Use basic display objects (text, multi-state indicators) with appropriate animation instead.
- You need only to generate an alarm from some condition you already have in your code. Use the P_Alarm Add-On Instruction or the ALMD built-in instruction instead.

Functional Description

The diagram shows the functional characteristics of the P_DIn Add-On Instruction.

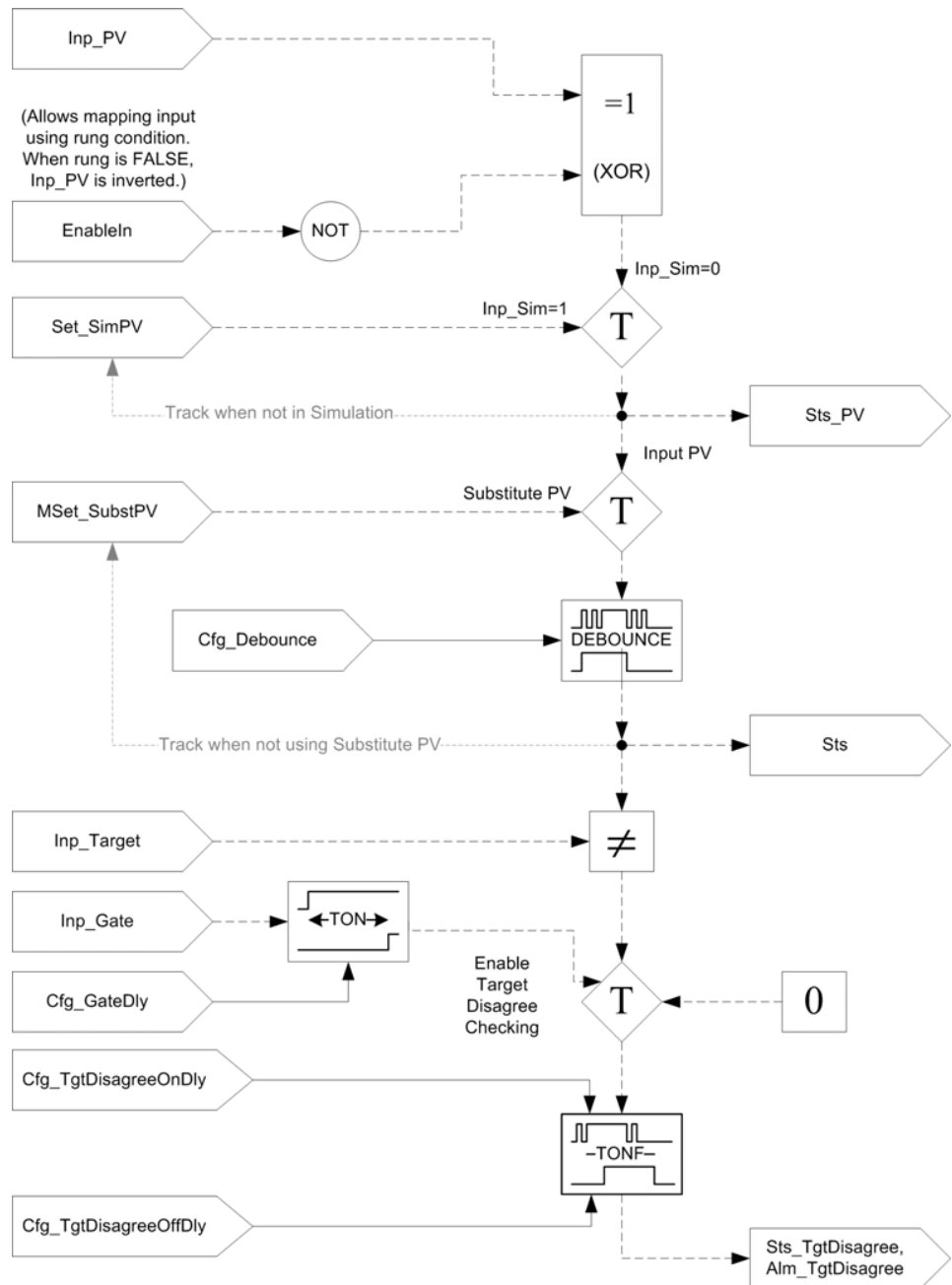

The P_DIn instruction provides the following capabilities:

- Display of the input state; the 0-state and 1-state names are configurable. The input state is also displayed independently, even when the input is substituted.
- Target Disagree status and optional alarm based on comparing the input state against a target (good) state. The Target Disagree status is enabled by a gating input signal with a configurable gate delay. The Target Disagree status and Alarm On-Delay and Off-Delay are configurable.
- Handle an I/O fault input by displaying the communication fault to the operator.
- Selection and entry of a manual (substitute) PV. This manual override is made clearly visible to the operator.
- Support for a simulated PV for use in instruction testing, demonstration, or operator training.

Required Files

Add-On Instructions are reusable code objects that contain encapsulated logic that can streamline implementing your system. This lets you create your own instruction set for programming logic as a supplement to the instruction set provided natively in the ControlLogix® firmware. An Add-On Instruction is defined once in each controller project, and can be instantiated multiple times in your application code as needed.

Controller File

The P_DIn_3_5-00_AOIL5X Add-On Instruction must be imported into the controller project to be used in the controller configuration. The service release number (boldfaced) can change as service revisions are created.

Visualization Files

<http://www.rockwellautomation.com/global/support/pcdc.page> This Add-On Instruction has associated visualization files that provide a common user interface. These files can be downloaded from the Product Compatibility and Download Center at

<http://www.rockwellautomation.com/rockwellautomation/support/pcdc.page>.

IMPORTANT The visualization file dependencies require Process Library content imports to occur in a specific order as reflected in the following tables:

- Images
- Global Objects
- Standard Displays
- HMI Tags
- Macros

Images are external graphic files that can be used in displays. They must be imported for FactoryTalk View to make use of them.

When PNG files are imported, they are renamed by FactoryTalk View with a .bmp file extension, but retain a .png format.

Table 2 - Visualization Files: Images (.png)

FactoryTalk View SE Software	FactoryTalk View ME Software	Description
All .png files in the images folder	All .png files in the images folder	These are the common icons used in the global objects and standard displays for all Process Objects.

The Global Object files (.ggfx file type) in the following table are Process Library display elements that are created once and referenced multiple times on multiple displays in an application. When changes are made to a Global Object, all instances in the application are automatically updated.

Table 3 - Visualization Files: Global Objects (.ggfx)

FactoryTalk View SE Software	FactoryTalk View ME Software	Description
(RA-BAS) Common Faceplate Objects	(RA-BAS-ME) Common Faceplate Objects	Global objects used on process object faceplates.
(RA-BAS) Process Alarm Objects	(RA-BAS-ME) Process Alarm Objects	Global objects used for managing alarms on process object faceplates.
(RA-BAS) Process Faceplate Misc Objects	(RA-BAS-ME) Process Faceplate Misc Objects	Miscellaneous global objects used on process object faceplates.
(RA-BAS) Process Graphics Library	(RA-BAS-ME) Process Graphics Library	Process global object device symbols used to build process graphics
(RA-BAS) Process Help Objects	(RA-BAS-ME) Process Help Objects	Global objects used for all process objects help displays.

The Standard Display files (.gfx file type) in the following table are the Process Library displays that you see at runtime.

Table 4 - Visualization Files: Standard Displays (.gfx)

FactoryTalk View SE Software	FactoryTalk View ME Software	Description
(RA-BAS) Common-AnalogEdit	N/A	Faceplate used for analog input data entry. The FactoryTalk View ME faceplates use the native analog input data entry so no file is required.
(RA-BAS) P_Alarm-Faceplate	(RA-BAS-ME) P_Alarm-Faceplate	The faceplate that is used for the object
(RA-BAS) P_Alarm-Help	(RA-BAS-ME) P_Alarm-Help	Alarm Help information that is accessed from the P_Alarm faceplate.
(RA-BAS) P_Din-Faceplate	(RA-BAS-ME) P_Din-Faceplate	The faceplate that is used for the object
(RA-BAS) P_Din-Quick	(RA-BAS-ME) P_Din-Quick	The Quick display that is used for the object
(RA-BAS) P_Gate-Faceplate	(RA-BAS-ME) P_Gate-Faceplate	The gate faceplate display used for the object.
(RA-BAS) Process Discrete Family-Help	(RA-BAS-ME) Process Discrete Family-Help	The Help display for Discrete objects

HMI Tags are created in a FactoryTalk View ME application to support tab switching on Process Library faceplates. The HMI tags may be imported via the comma-separated values file (.csv file type) in the following table.

Table 5 - Visualization Files: HMI Tags (.csv)

FactoryTalk View SE Software	FactoryTalk View ME Software	Description
N/A	FTVME_PlantPAXLib_Tags_3_5_XX.csv where XX = the service release number.	These tags must be imported into the FactoryTalk View ME project to support switching tabs on any Process Object faceplate.

Controller Code

This section describes the parameter references for this Add-On Instruction.

Input Structure for Discrete Input

Input parameters include the following:

- Input data elements (Inp_) are typically used to connect field inputs from I/O modules or signals from other objects.
- Configuration data elements (Cfg_) are used to set configurable capabilities and features of the instruction.
- Commands (PCmd_, OCmd_, MCmd_) are used by program logic, operators, and maintenance personnel to request instruction actions.
- Settings (PSet_, OSet_, MSet_) are used by program logic, operators, and maintenance personnel to establish runtime setpoints, thresholds, and so forth. A Setting (without a leading P, O, or M) establishes runtime settings regardless of role or mode.

Table 7 - P_DIn Input Parameters

Input Parameter	Data Type	Alias For	Default	Description
EnableIn	BOOL		1	<p>Ladder Diagram: If the rung-in condition is true, the instruction's Logic routine executes. If the rung-in condition is false, the instruction's EnableInFalse routine executes.</p> <p>Function Block Diagram: If true, or not connected, the instruction's Logic routine executes. If the parameter is exposed as a pin and wired, and the pin is false, the instruction's EnableInFalse routine executes.</p> <p>Structured Text: No effect. The instruction's Logic routine executes.</p>
Inp_PV	BOOL		1	Input signal (process variable) from sensor.
Inp_PVBad	BOOL		0	Bad Signal Quality/Communication Status for Inputs (1 = Bad, 0 = OK). If PV is read from a discrete input, then this is normally read from the discrete input module fault status.
Inp_Target	BOOL		1	Target state of input (alarm if not in target state).
Inp_Gate	BOOL	TgtDisagreeGate.Inp_Gate	1	<p>This parameter is the gate input used for status detection. When set to 1, the target disagree monitoring is enabled. The on-delay and off-delay timers are applied after the gate delay timer. When set to 0, detection is disabled and the target disagree status output is forced off.</p> <p>If the status is used as an alarm, this input acts as a suppression-by-design condition.</p>
Inp_Sim	BOOL		0	Simulation input. When set to 1, the instruction uses simulation parameters (for example, Set_SimPV) to calculate output. When set to 0, the instruction uses input parameters (for example, Inp_PV) to calculate output.
Inp_Reset	BOOL		0	Input parameter used to programatically reset alarms. When set to 1, all alarms requiring reset are reset.
Cfg_NoSubstPV	BOOL		0	<p>This parameter provides the ability to disable the maintenance substitution feature. When this parameter is 0, the Substitute PV Maintenance is allowed. When this parameter is 1, the Substitute PV Maintenance function is disallowed.</p> <p>When Cfg_NoSubstPV is 0, the commands MCmd_SubstPV and MCmd_InpPV are used to select the input PV or the substitute PV. Sts_SubstPV is 1 when the substitute PV is selected.</p>
Cfg_NormTextVis	BOOL		1	<p>1 = Display state text in Normal state (= target).</p> <p>0 = Hide state text in Normal state (some HMI objects).</p>

Table 7 - P_DIn Input Parameters

Input Parameter	Data Type	Alias For	Default	Description
Cfg_PCmdClear	BOOL		1	When this parameter is 1, program commands are cleared once they are acted upon. When set to 0, program commands remain set until cleared by the application program logic. This parameter is aliased to internal tag Mode.Cfg_PCmdClear from P_Mode. IMPORTANT: Clearing this parameter online can cause unintended program command execution.
Cfg_HasTgtDisagreeAlm	BOOL	TgtDisagree.Cfg_Exists	0	1 = Target Disagree alarm exists and is checked.
Cfg_TgtDisagreeResetReqd	BOOL	TgtDisagree.Cfg_ResetReqd	0	This parameter determines whether a reset is required to clear the alarm status. When this parameter is 1, the alarm is latched ON when the alarm occurs. After the alarm condition returns to normal, a reset is required to clear the alarm status (for example, OCmd_Reset or Inp_Reset are required to clear Alm_TgtDisagree after the alarm is set and the value returns to normal). When this parameter is 0, no reset is required and the alarm status is cleared when the alarm condition returns to normal. IMPORTANT: If the reset clears the alarm, it also acknowledges the alarm.
Cfg_TgtDisagreeAckReqd	BOOL	TgtDisagree.Cfg_AckReqd	1	This parameter determines whether an acknowledgement is required for an alarm. When this parameter is 1, the acknowledge (ack) bit is cleared when the alarm occurs. An acknowledge command (for example, PCmd_Ack or .OCmd_Ack) is required to acknowledge the alarm. When set to 0, the Acknowledge bit is set when an alarm occurs, indicating an acknowledged alarm and no acknowledge command is required.
Cfg_TgtDisagreeSeverity	INT	TgtDisagree.Cfg_Severity	750	This parameter determines the severity of each alarm. This drives the color and symbol that are used to indicate alarm status on the faceplate and global object. The following are valid values: 1...250 = Low 251...500 = Medium 501...750 = High 751...1000 = Urgent IMPORTANT: For FactoryTalk View software version 7.0, this severity parameter drives only the indication on the global object and faceplate. The Alarms and Events definition severity drives the color and symbol that is used on the alarm banner and alarm summary as well as the value returned by FactoryTalk Alarms and Events display commands.
Cfg_GateDly	DINT	TgtDisagreeGate.Cfg_GateDly	0	Time Inp_Gate must be true before alarm is checked (seconds).
Cfg_Debounce	REAL		0.0	Minimum time status must maintain state (seconds).
Cfg_TgtDisagreeOnDly	DINT	TgtDisagreeGate.Cfg_OnDly	0	This parameter determines the minimum time (in seconds) the PV must disagree with the target for the status to be set. On-delay times are used to avoid unnecessary alarms when an output (Val) overshoots its threshold (for example, Val_HiHiLim).
Cfg_TgtDisagreeOffDly	DINT	TgtDisagreeGate.Cfg_OffDly	0	This parameter determines the amount of time (in seconds) the PV must agree with the target to clear the status. Off-delay times are used to reduce chattering alarms. EXAMPLE: If Cfg_OffDly is 5 seconds, the PV must agree with the target for 5 seconds before the status is returned to normal.
MSet_SubstPV	BOOL		0	Operator-entered substitute PV.
Set_SimPV	BOOL		0	PV used in Simulation (Inp_Sim = 1).
PCmd_Reset	BOOL		0	<ul style="list-style-type: none"> Set PCmd_Reset to 1 to reset all alarms requiring reset This parameter is always reset automatically
PCmd_TgtDisagreeAck	BOOL	TgtDisagree.PCmd_Ack	0	<ul style="list-style-type: none"> Set PCmd_<Alarm>Ack to 1 to Acknowledge alarm The parameter is reset automatically

Table 7 - P_DIn Input Parameters

Input Parameter	Data Type	Alias For	Default	Description
PCmd_TgtDisagreeSuppress	BOOL	TgtDisagree.PCmd_Suppress	0	When Cfg_PCmdClear is 1: <ul style="list-style-type: none"> Set PCmd_<Alarm>Suppress to 1 to suppress alarm Set PCmd_<Alarm>Unsuppress to 1 to unsuppress alarm These parameters reset automatically When Cfg_PCmdClear is 0: <ul style="list-style-type: none"> Set PCmd_<Alarm>Suppress to 1 to suppress alarm Set PCmd_<Alarm>Suppress to 0 to unsuppress alarm PCmd_<Alarm>Unsuppress is not used These Parameters do not reset automatically
PCmd_TgtDisagreeUnsuppress	BOOL	TgtDisagree.PCmd_Unsuppress	0	
PCmd_TgtDisagreeUnshelve	BOOL	TgtDisagree.PCmd_Unshelve	0	<ul style="list-style-type: none"> Set PCmd_<Alarm>Unshelve to 1 to Unshelve alarm The parameter is reset automatically
MCmd_SubstPV	BOOL		0	Maintenance command to use substitute PV (override input).
MCmd_InpPV	BOOL		0	Maintenance command to use input PV (normal).
OCmd_Reset	BOOL		0	Operator command to reset all latched alarms.
OCmd_ResetAckAll	BOOL		0	Operator command to reset and acknowledge all alarms.

Output Structure for Discrete Input

Output parameters include the following:

- Value data elements (Val_) are numeric outputs of the instruction for use by the HMI. Values also can be used by other application logic or software packages.
- Source and Quality data elements (SrcQ_) are outputs of the instruction used by the HMI to indicate PV source and quality.
- Status data elements (Sts_) are bit outputs of the instruction for use by the HMI. Status bits also can be used by other application logic.
- Error data elements (Err_) are outputs of the instruction that indicate a particular configuration error. If any Err_ bit is set then the Sts_Err configuration error summary status is set and the Invalid Configuration indicator is displayed on the HMI.
- Alarm data elements (Alm_) are outputs of the instruction that indicate a particular alarm has occurred.
- Acknowledge data elements (Ack_) are outputs of the instruction that indicate the corresponding alarm has been acknowledged.
- Ready data elements (Rdy_) are bit outputs of the instruction used by the HMI to enable or disable command buttons and Setting entry fields.

Table 8 - P_DIn Output Parameters

Output Parameter	Data Type	Alias For	Description
EnableOut	BOOL		Enable Out: The EnableOut signal is not manipulated by this instruction. Its output always reflects EnableIn Input state.

Table 8 - P_DIn Output Parameters

Output Parameter	Data Type	Alias For	Description
SrcQ_IO	SINT		I/O signal source and quality.
SrcQ			Final output source and quality: GOOD 0 = I/O live and confirmed good quality 1 = I/O live and assumed good quality 2 = No feedback configured, assumed good quality TEST 8 = Device simulated 9 = Device loopback simulation 10 = Manually entered value UNCERTAIN 16 = Live input, off-specification 17 = Value substituted at device/bus 18 = Value substituted by maintenance (Has and not Use) 19 = Shed, using last good value 20 = Shed, using replacement value BAD 32 = Signal failure (out-of-range, NaN, invalid combination) 33 = I/O channel fault 34 = I/O module fault 35 = Bad I/O configuration (for example, scaling parameters)
Val_Sts	SINT		Device confirmed status: 0 = PV Good 6 = PV Bad 7 = Substitute PV
Val_Fault	SINT		Device fault status: 0 = None 16 = Target Disagree 34 = Configuration Error
Val_Notify	SINT		Current alarm level and acknowledgement (enumeration): 0 = No alarm 1 = Alarm cleared: a reset or acknowledge is required 2 = Low (acknowledged) 3 = Low (unacknowledged) 4 = Medium (acknowledged) 5 = Medium (unacknowledged) 6 = High (acknowledged) 7 = High (unacknowledged) 8 = Urgent (acknowledged) 9 = Urgent (unacknowledged)
Sts	BOOL		Discrete input status (including de-bounce and manual override, if used).
Sts_PV	BOOL		Discrete input status (actual, not subject to override).
Sts_SubstPV	BOOL		1 = Using substitute PV (input being overridden).
Sts_InpPV	BOOL		1 = Using input PV (normal).
Sts_PVBad	BOOL		Input status/quality: 0 = OK 1 = Bad
Sts_MaintByp	BOOL		1 = Device has a Maintenance Bypass function active.
Sts_AlMnh	BOOL		1 = One or more alarms inhibited, disabled or suppressed.
Sts_Err	BOOL		1 = Error in configuration: see detail bits for reason.
Err_Timer	BOOL		1 = Error in configuration: invalid timer preset (use 0...2,147,483).
Err_Alarm	BOOL		1 = Error in configuration: alarm minimum on time or severity.
Sts_TgtDisagreeCmp	BOOL	TgtDisagreeGate.Inp	Input versus Target comparison result 1 = Disagree.

Table 8 - P_DIn Output Parameters

Output Parameter	Data Type	Alias For	Description
Sts_TgtDisagreeGate	BOOL	TgtDisagreeGate.Sts_Gate	Target Disagree Gate Delay Status 1 = done.
Sts_TgtDisagree	BOOL	TgtDisagree.Inp	1 = Input is not in target state.
Alm_TgtDisagree	BOOL	TgtDisagree.Alm	1 = Alarm: input is not in target state.
Ack_TgtDisagree	BOOL	TgtDisagree.Ack	1 = Target Disagree alarm has been acknowledged.
Sts_TgtDisagreeDisabled	BOOL	TgtDisagree.Disabled	1 = Target Disagree alarm is disabled (by Maintenance).
Sts_TgtDisagreeSuppressed	BOOL	TgtDisagree.Suppressed	1 = Target Disagree alarm is suppressed (by Program).
Sts_TgtDisagreeShelved	BOOL	TgtDisagree.Shelved	1 = Target Disagree alarm is shelved (by Operator).
Rdy_SubstPV	BOOL		1 = Ready for MCmd_SubstPV.
Rdy_InpPV	BOOL		1 = Ready for MCmd_InpPV.
Rdy_Reset	BOOL		1 = At least one alarm requires reset.
Rdy_ResetAckAll	BOOL		1 = At least one alarm requires acknowledgement.
P_DIn	BOOL		Unique Parameter Name for auto-discovery.

Local Configuration Tags for Discrete Input

Configuration parameters that are array, string, or structure data types cannot be configured as parameters for Add-On Instructions. Configuration parameters of these types appear as local tags to the Add-On Instruction. Local tags can be configured through the HMI faceplates or in Studio 5000 Logix Designer® application by opening the instruction logic of the Add-On Instruction instance and then opening the Data Monitor on a local tag. These parameters cannot be modified by using controller logic or Logix Designer application export/import functionality.

Tag Name	Data Type	Default	Description
Cfg_0StText	STRING_8	'Off'	Text to display in PV 0 State.
Cfg_1StText	STRING_8	'On'	Text to display in PV 1 State.
Cfg_Desc	STRING_40	'Discrete Input'	Description for display on HMI. This string is shown in the title bar of the faceplate.
Cfg_Label	STRING_20	'Discrete Input'	Label for graphic symbol displayed on HMI. This string appears on the graphic symbol.
Cfg_Tag	STRING_20	'P_DIn'	Tagname for display on HMI. This string is shown in the title bar of the faceplate.

Operations

This section describes the primary operations for Add-On Instructions.

Modes

The Discrete Input Add-On Instruction does not use modes and does not contain an embedded P_Mode Add-On Instruction. Alarm acknowledge, reset, disable, suppress, inhibit, and related commands are accepted at any time. Operator commands are restricted via the security functions of the HMI.

Enabling and disabling the substitute PV function can be done by maintenance personnel, subject to HMI security rights and Engineering configuration at any time. Once the substitute PV function is enabled, the operator can enter a substitute PV Value, subject to HMI security rights, at any time.

Alarms

This instruction uses the following alarms, which are implemented by using embedded P_Alarm and P_Gate Add-On Instructions.

Alarm Name	P_Alarm Name	P_Gate Name	Description
Target Disagree	TgtDisagree	TgtDisagreeGate	Raised when the Input PV is not in the same state as the Target (Inp_Target). Gating, and timing are set in configuration.

Parameters of the P_Alarm object can be accessed by using the following convention: [P_Alarm Name].[P_Alarm Parameter].

For more information, see the following Rockwell Automation Library of Process Objects publications:

- Common Alarm Block (P_Alarm) Reference Manual, publication [SYSLIB-RM002](#)
- Condition Gate Delay (P_Gate) Reference Manual, publication [SYSLIB-RM041](#)

Simulation

Simulation in P_DIn provides a simulated 0-state or 1-state input (Inp_PV) that you can process as if it were an actual input.

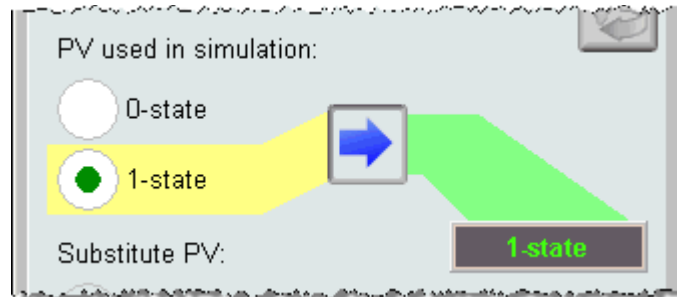

You must set the Inp_Sim parameter in the controller to '1' to enable simulation.

The Simulation icon  is displayed at the bottom left of the Operator faceplate, indicating the device is in simulation.

When you have finished in simulation, set the Inp_Sim parameter in the controller to '0' to return to normal operation.

Execution

The following table explains the handling of instruction execution conditions.

Condition	Description
EnableIn False (false rung)	Processing for EnableIn False (false rung) is handled the same as the main logic routine except that the state of Inp_PV is inverted. This allows the P_DIn Add-On Instruction in a Ladder Diagram instance to have its input mapped by using an XIC of the input on the rung with the P_DIn instruction instead of using a separate branch or rung to map the input. Inp_PV is set to 1 (or 0 as appropriate) when using the on-rung mapping.
Powerup (prescan, first scan)	Since the P_DIn Add-On Instruction uses standard TON timers for status On-delay, Off-delay, and Gate Timing, on Powerup or prescan, the status initiates as if the Gate input had been changed from 0 to 1.
Postscan (SFC transition)	No SFC postscan logic is provided.

Refer to the Logix5000 Controllers Add-On Instructions Programming Manual, publication [1756-PM010](#), for more information.

Implementation by Using the EnableIn False Feature

For the convenience of Ladder Diagram programmers, the P_DIn instruction can be used in a Ladder Diagram Routine with the input condition carried by the Rung-In condition instead of being mapped on a separate branch.

The following illustration shows normal implementation with the input condition mapped to Inp_PV on a separate branch.

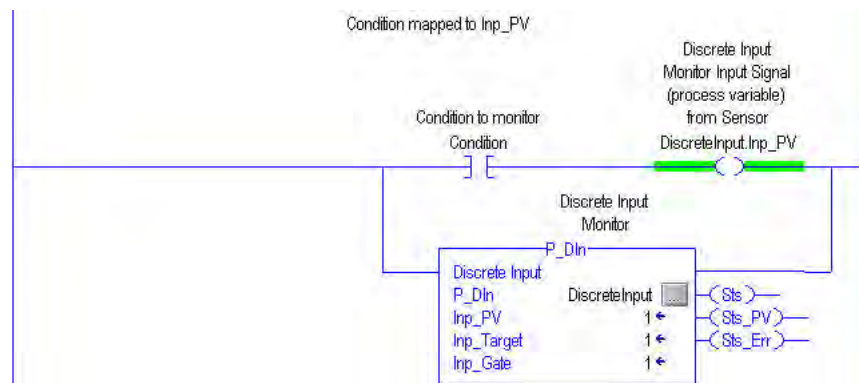

The following illustration shows EnableIn FALSE implementation with the input condition mapped to the P_DIn instruction by using the Rung-In state.

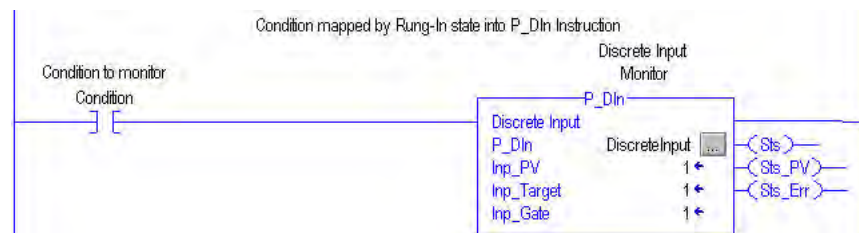

The Rung-In condition determines whether the Add-On Instruction's normal code ('Logic' Routine) is executed or its EnableIn False code ('EnableInFalse' Routine) is executed. In the P_DIn instruction, the EnableIn False code is identical to the Logic code, except it uses the inverse of the Inp_PV signal for processing. To use the Rung-In mapping, method, set Inp_PV to 1 (its default value). When the rung is TRUE, Inp_PV (= 1) is treated as TRUE (not inverted), and when the rung is FALSE, Inp_PV (= 1) is treated as FALSE (inverted).

Programming Example

A simple example of P_DIn using a function block is provided below. In this example, tag I_VSH_P50 is the digital process value being monitored by the P_DIn block. This tag provides a Boolean indication of High Vibration. The bad quality indication for the process value (Inp_PVBad) comes from the connection status indication on the input module.

Inp_Target is defaulted to 1 indicating that the normal condition for I_VSH_P50 is also 1 (tag comments confirm 1=OK for this process value). Inp_Gate is connected to the Motor Running status tag (P50_Running) that comes from the Sts_Running output of the P_Motor block instance for this motor (P50_Motor). When P50_Running is True, On Delay/Off Delay timing is applied to the target disagree status (Sts_TgtDisagree) output of the block (in other words, the output Sts_TgtDisagree will not indicate disagreement/agreement between the Inp_PV target values until after the gate delay/delay times have expired). The gate delay is configured to give the motor sufficient time after starting to settle into full normal speed run before enabling the high vibration indication and alarm. The On Delay/Off Delay values are set as normal configuration parameters.

Finally, P50_HighVibr is the output tag that will indicate the status of I_VSH_P50 with appropriate gate delays based on whether the motor is running.

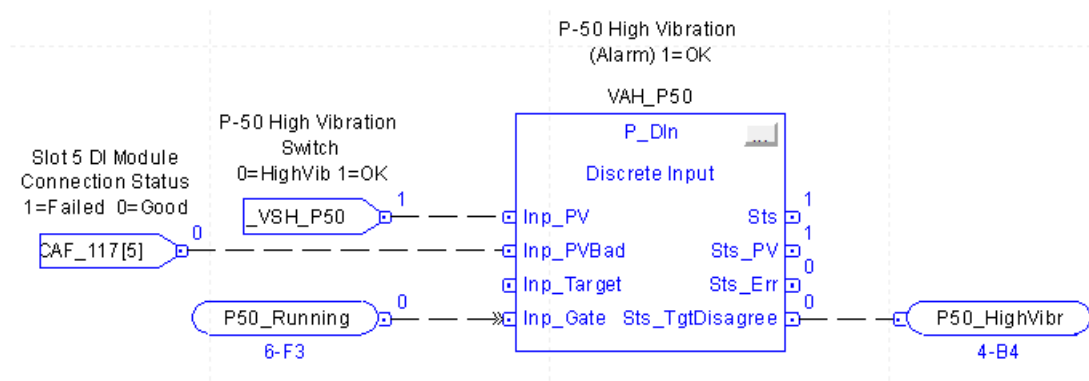

Display Elements

A display element (global object) is created once and can be referenced multiple times on multiple displays in an application. When changes are made to the original (base) object, the instantiated copies (reference objects) are automatically updated. Use of global objects, in conjunction with tag structures in the ControlLogix system, aid consistency and save engineering time.

Table 9 - P_DIn Display Elements Description

Display Element Name	Display Element	Description
GO_P_DIn		Global object with label.
GO_P_DIn1		Global object without label.

Common attributes of the P_DIn instruction global objects include the following:

- Current value of the PV
- Maintenance Bypass indicator
- Label
- Color changing alarm border that blinks on unacknowledged alarm
- Alarm indicator that changes color with the severity of an alarm
- Status/Quality indicator

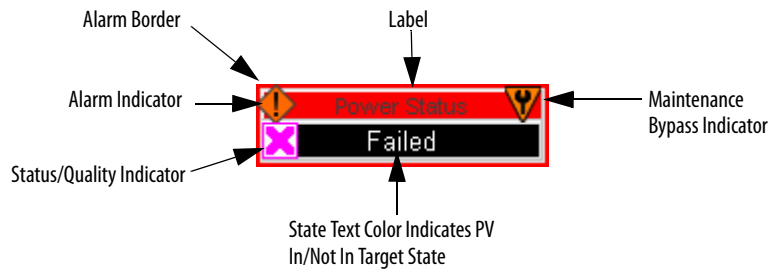

Status/Quality Indicators

One of these symbols appears on the graphic symbol when the described condition is true.

Graphic Symbol	Description
	Invalid configuration.
	Data quality bad/failure.
	Data Quality degraded: uncertain, test, simulation, substitution, or out of specification.
	Input PV matches target.
	Input PV does not match target.
No symbol displayed	I/O communication and quality good, configuration valid.

TIP When the Invalid Configuration indicator appears, you can find what configuration setting is invalid by following the indicators. Click the display element to open the faceplate. The Invalid Configuration indicator appears next to the appropriate tab at the top of the faceplate to guide you in finding the configuration error. Once you navigate to the tab, the misconfigured item is flagged with this indicator or appears in a magenta box.







For the P_DIn instruction, the Invalid Configuration indicator appears under the following conditions:

- De-bounce time is set to a value less than zero or greater than 2,147,483 seconds.
- Alarm gate delay is set to a value less than zero or greater than 2,147,483 seconds.
- Alarm minimum duration is set to a value less than zero or greater than 2,147,483 seconds.

Alarm Severity is set to a value less than 1 or greater than 1000.

Alarm Indicators

One of these symbols appears on the left of the label to indicate the described alarm condition. The alarm border and label background blink if Acknowledgement of an alarm condition is required. Once the alarm is acknowledged, the alarm border and label background remain the color that corresponds to the severity of the alarm.

Symbol	Border and Label Background	Description
	No change in color	Alarm Inhibit: an alarm is suppressed by the Program, disabled by Maintenance, or shelved by the Operator.
	White	Return to normal (no alarm condition), but a previous alarm has not been acknowledged.
	Blue	Low severity alarm.
	Yellow	Medium severity alarm.
	Red	High severity alarm.
	Magenta	Urgent severity alarm.
No symbol	No change in color	No alarm or alarm inhibit condition, and all alarms are acknowledged.

See Rockwell Automation Library of Process Objects: Common Alarm Block (P_Alarm) Reference Manual, publication [SYSLIB-RM002](#), for more information.

Maintenance Bypass Indicator

This symbol appears to the right of the label to indicate that a maintenance bypass has been activated.

Graphic Symbol	Description
	A maintenance bypass is active.
No symbol displayed	No maintenance bypass is active.

TIP When the Maintenance bypass indicator appears, you can find what condition was bypassed by following the indicators. Click the graphic symbol to open the faceplate. The Maintenance bypass indicator appears next to the appropriate tab at the top of the faceplate to guide you in finding the bypass. Once you navigate to the tab, the bypassed item is flagged with this indicator.

For the P_DIn instruction, the Maintenance Bypass indicator appears when the substitute PV function has been enabled. The live PV is being superseded by a Maintenance-entered value.

Using Display Elements

This global object for the P_DIn instruction can be found in the global object file (RA-BAS) Process Graphics Library.ggfx. Follow these steps to use a global object.

1. Copy the global object from the global object file and paste it in the display file.

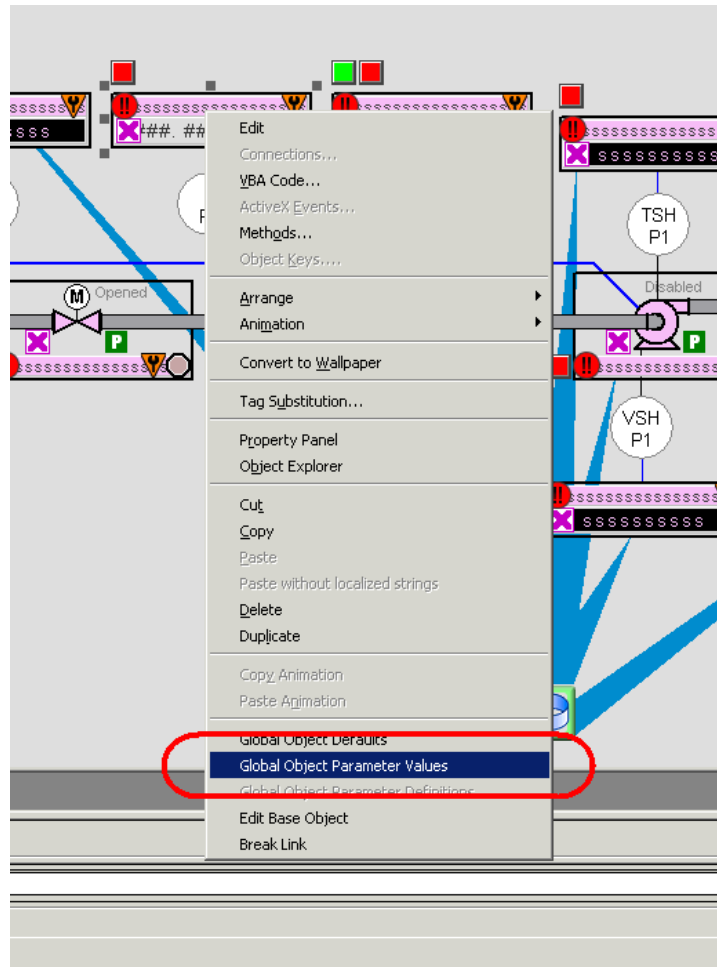

2. In the display, right-click the global object and choose Global Object Parameter Values.

The Global Object Parameter Values dialog box appears.

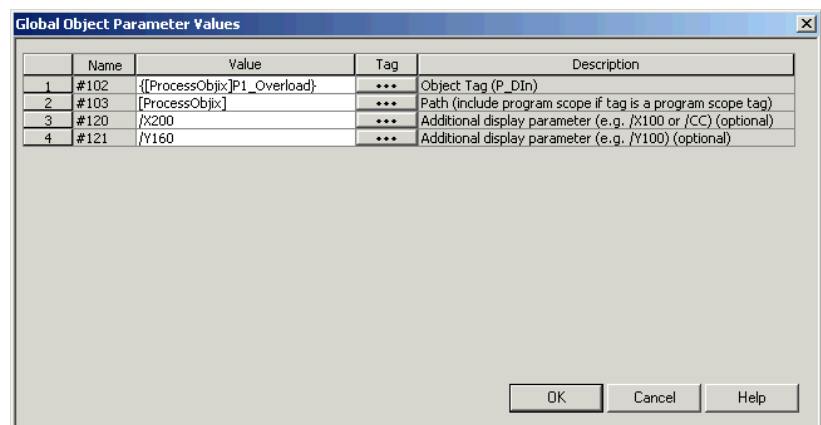

The global object parameters are as follows.

Parameter	Required	Description
#102	Y	Object tag to point to the name of the associated object Add-On Instruction in the controller.
#103	Y	Path used for display navigation features to other objects. Include program scope if tag is a program scope tag.
#120	N	Additional parameter to pass to the display command to open the faceplate. Typically used to define position for the faceplate.
#121	N	Additional parameter to pass to the display command to open the faceplate. If defining X and Y coordinate, separate parameters so that X is defined by #120 and Y is defined by #121. This allows these same parameters to be used in subsequent display commands originating from the faceplate.

- In the Value column, type the tag or value as specified in the Description column.

TIP Click the ellipsis (...) to browse and select a tag.
 Values for items marked '(optional)' can be left blank.

- Click OK.

Faceplate

The P_DIn faceplate consists of four tabs and each tab consists of one or more pages.

The title bar of the faceplate contains the value of local configuration tags Cfg_Tag and Cfg_Desc.

Tag - Description

The Operator tab is displayed when the faceplate is initially opened. Click the appropriate icon at the top of the faceplate to access a specific tab.

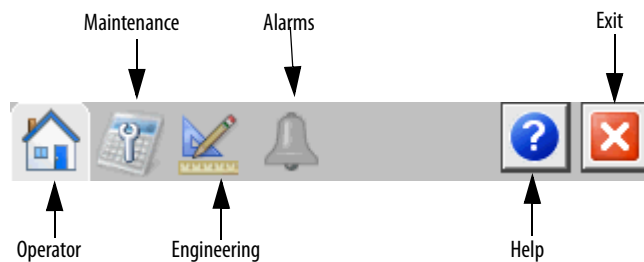

The faceplate provides the means for operators, maintenance workers, engineers, and others to interact with the P_DIn instruction instance, including viewing its status and values and manipulating it through its commands and settings. When a given input is restricted via FactoryTalk View software security, the required user security code letter is shown in the following tables that follow.

Operator Tab

The Faceplate initially opens to the Operator ('Home') tab. From here, an operator can monitor the device status and manually operate the device when it is in Operator mode.

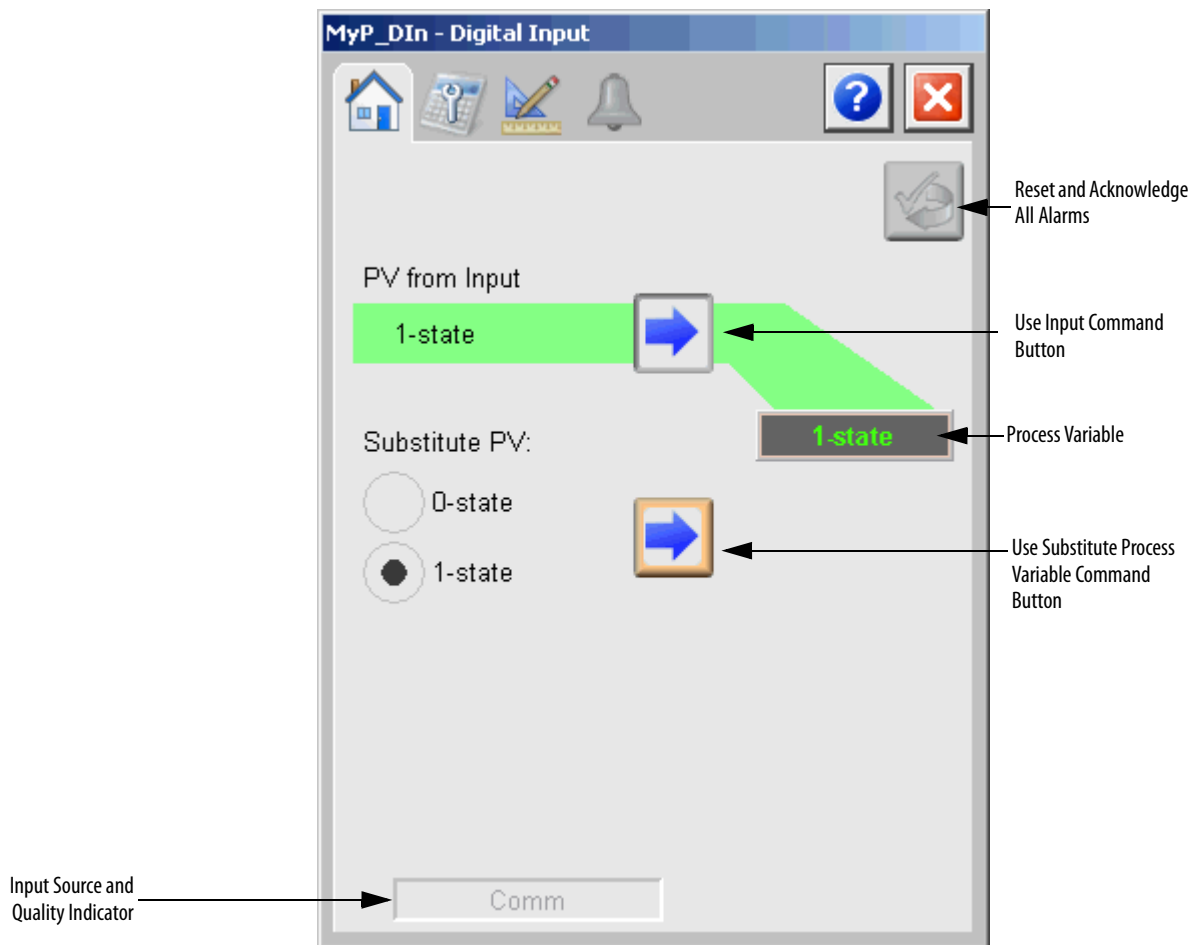

The Operator tab shows the following information:

- Current Process Variable (PV)
- Input value
- Input Source and Quality indicator (see 'SrcQ' in the Output parameters table on [page 14](#) for details)









The following table shows the functions included on the Operator tab.

Table 10 - Operator Tab Descriptions

Function	Action	Security
	Click to Select Input (normal) PV.	Equipment Maintenance (Code C)
	Click to Select Substitute PV.	
	Click to Reset and Acknowledge All Alarms.	Acknowledge Alarms (Code F)
Substitute PV: 0-state	Click to write a '0' to MSet_SubstPV.	Equipment Maintenance (Code C)
Substitute PV: 1-state	Click to write a '1' to MSet_SubstPV.	
PV used in simulation: 0-state	Click to write a '0' or a '1' to Set_SimPV. These options are available only in Simulation.	Normal Operation of Devices (Code A)
PV used in simulation: 1-state		

The following table shows the alarm status on the Operator tab.

Table 11 - Operator Tab Alarm Status

Graphic Symbol	Alarm Status
	In alarm (active alarm)
	In alarm and acknowledged
	Out of alarm but not acknowledged
	Alarm suppressed (by Operator) (alarm is logged but not displayed)
	Alarm disabled (by Maintenance)
	Alarm shelved (disabled by Program logic)

Alarm indicators appear on the Operator tab when the corresponding alarm occurs.

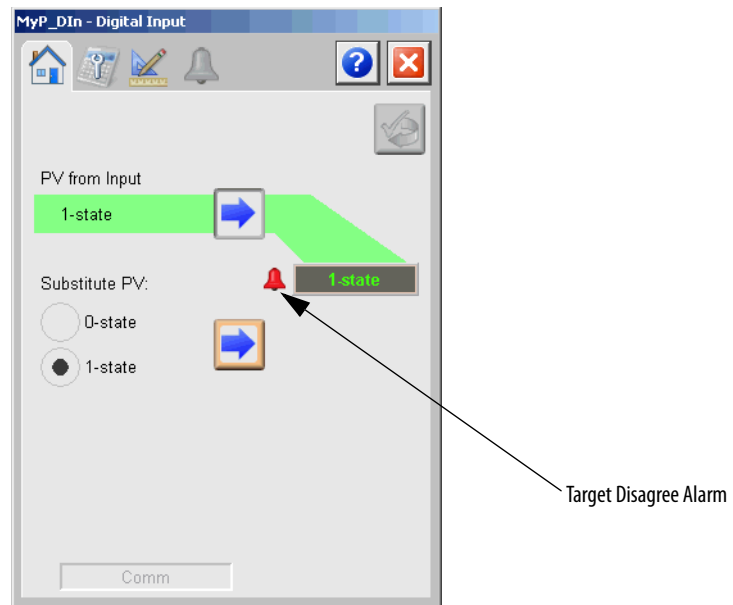

Maintenance Tab

Maintenance personnel use the information and controls on the Maintenance tab to make adjustments to device parameters, troubleshoot and temporarily work around device problems, and disable the device for routine maintenance.

The Maintenance tab shows the following information:

- Current PV
- Input PV (or simulated PV when simulation is enabled)
- Selected and de-bounced input PV
- Target PV
- Gate condition
- Animation highlights how the final PV current value was determined

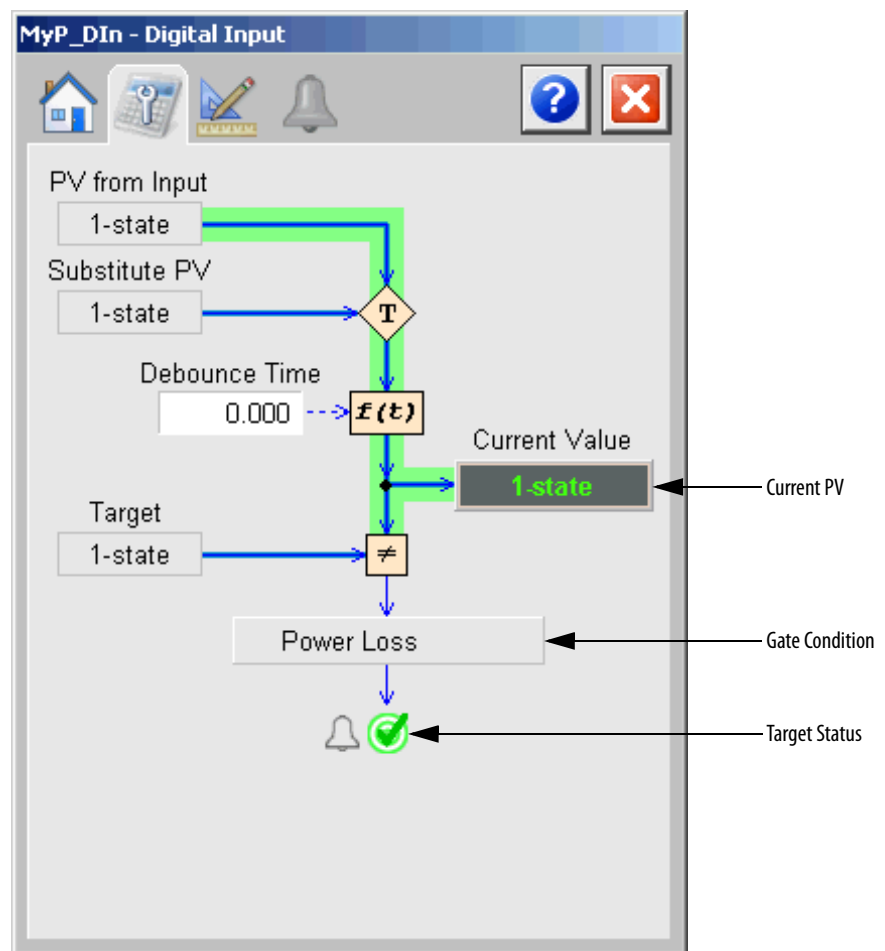

Click Gate Condition to open the P_Gate faceplate. From the P_Gate faceplate, you can configure and perform additional operations for each alarm, including Gate Delay, Status On-delay, Status Off-delay, and condition text.

The following table shows the functions on the Maintenance tab.

Table 12 - Maintenance Tab Description

Function	Action	Security	Configuration Parameters
De-bounce Time (Seconds)	Type the amount of de-bounce time in seconds.	Configuration and Tuning Maintenance (Code D)	Cfg_Debounce
Gate Condition	Click to open the Gate faceplate.	None	None

Refer to the Rockwell Automation Library of Process Objects: Condition Gate Delay (P_Gate) Reference Manual, publication [SYSLIB-RM041](#), for more information.

Engineering Tab

The Engineering tab provides access to device configuration parameters and ranges, options for device and I/O setup, displayed text, and faceplate-to-faceplate navigation settings, for initial system commissioning or later system changes.

On the Engineering tab, you can configure the description, label, tag, and PV units for the device.

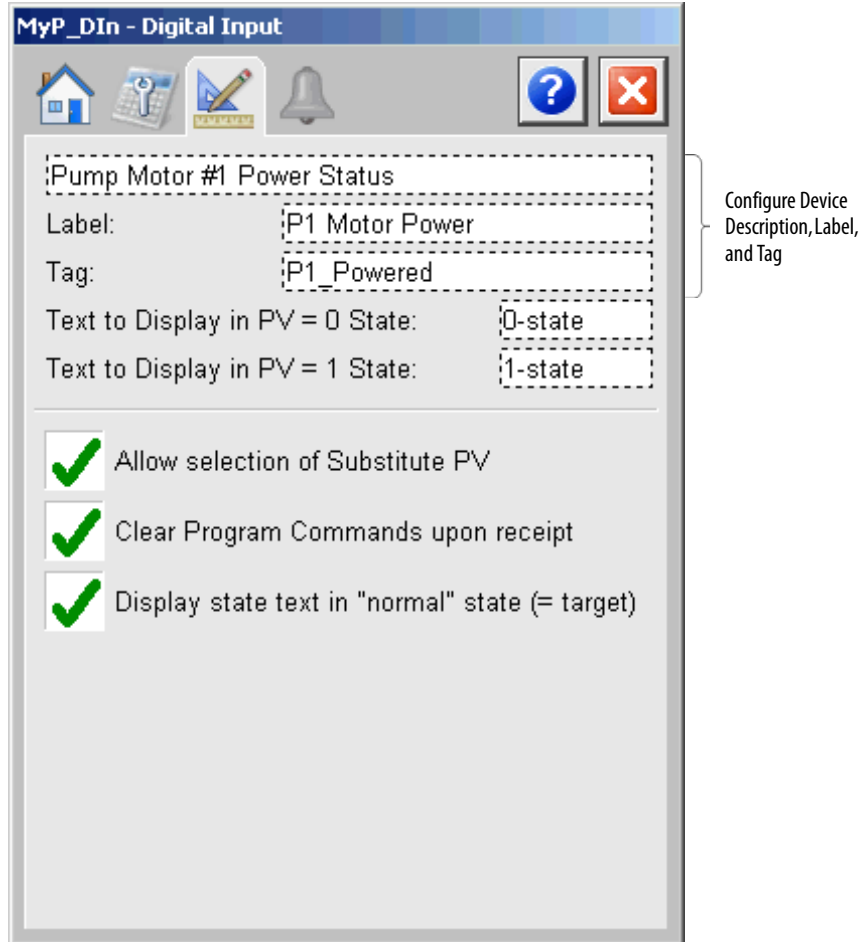

The following table lists the functions on the Engineering tab.

Table 13 - Engineering Tab Description

Function	Action	Security	Configuration Parameters
Description	Type the device description to show on the faceplate title bar.	Engineering Configuration (Code E)	Cfg_Desc
Label	Type the label to show on the graphic symbol.		Cfg_Label
Tag	Type the text to show on the tooltip and the title bar of each faceplate. IMPORTANT: Pausing the mouse over this field displays a tool tip with the configured Logix tag/path.		Cfg_Tag
Text to Display in PV = 0 State	Type text to display in PV 0 State.		Cfg_0StText
Text to Display in PV = 1State	Type text to display in PV 1 State.	Engineering Configuration (Code E)	Cfg_1StText
Allow Selection of Substitute PV	Check to enable the maintenance substitution feature.		Cfg_NoSubstPV
Clear Program Commands upon receipt	Check to clear program commands once they are acted upon. Clear the checkbox so that program commands remain set until cleared by the application program logic.		Cfg_PCmdClear
Display state text in 'normal' state (= target)	Check to display state text in normal state (for certain display elements).		Cfg_NormTextVis

Alarms Tab

The Alarms tab displays each configured alarm for the P_DIn instruction. The icon on the tab for the Alarms page changes color based on the current active alarms. A blinking alarm icon indicates that one or more alarms must be acknowledged or the device must be reset.

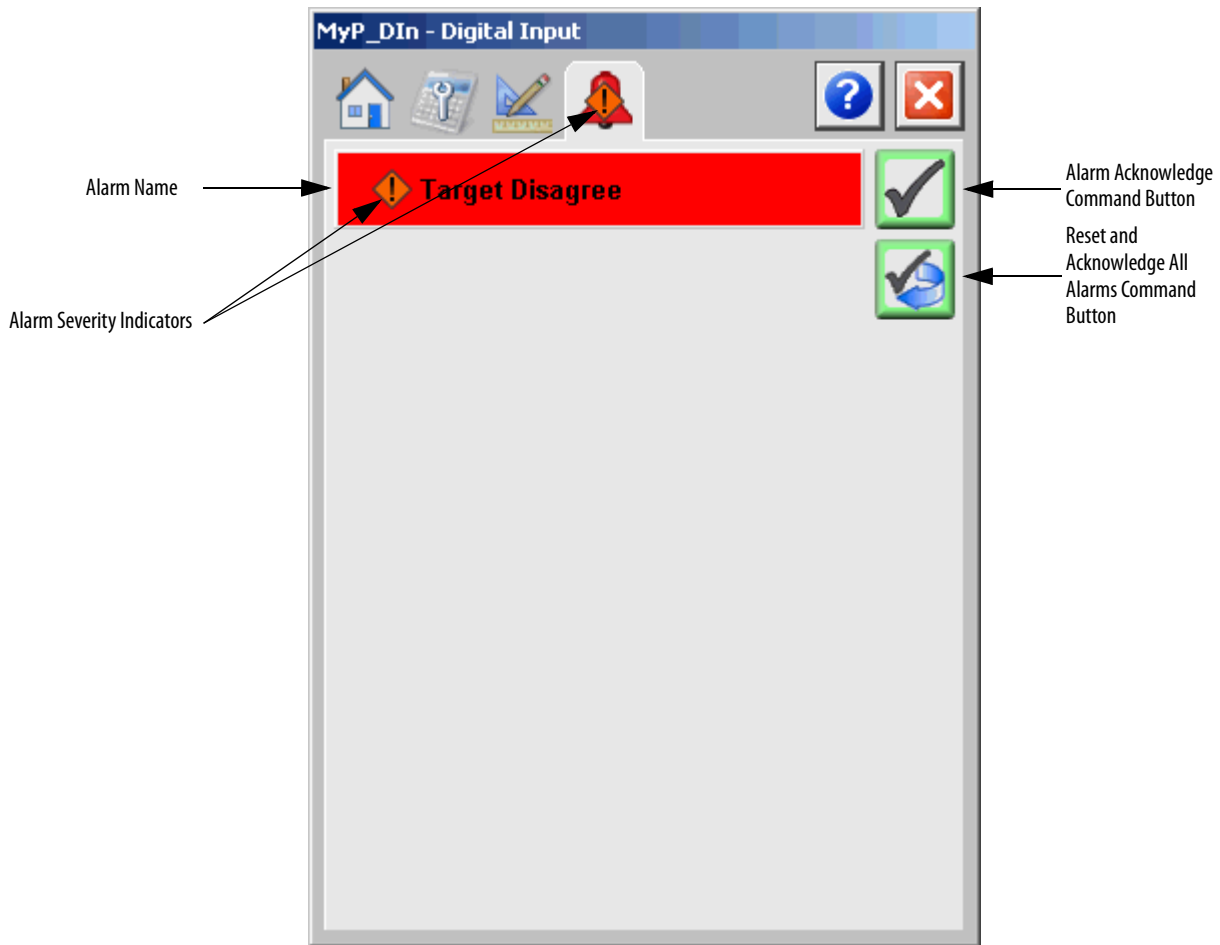

Click an alarm name to open the P_Alarm faceplate for that alarm. From the P_Alarm faceplate, you can configure and perform additional operations on the alarm.



If an alarm is active, the panel behind the alarm changes color to match the severity of the alarm. The color of the bell icon at the top of the faceplate shows the severity of the highest active alarm, and the icon blinks if any alarm is unacknowledged or requires reset.

Table 14 - Alarm Severity Colors

Color	Definition
Magenta	Urgent
Red	High
Yellow	Medium
Blue	Low
White (bell icon)	Alarm has cleared but is unacknowledged
Background (Light Gray)	No alarm

The following table shows the functions on the Alarms tab.

Table 15 - Alarms Tab Description

Function	Action	Security
Alarm Name	Click an alarm name to open the associated P_Alarm faceplate.	None
	Click to acknowledge the alarm.	Acknowledge Alarms (Code F)
	Click to reset and acknowledge all alarms.	









When the Reset and Acknowledge All Alarms button is enabled, the panel behind the alarm blinks, indicating the alarm requires acknowledgement or reset. The Alarm Acknowledge button is enabled if the alarm requires acknowledgment. Click the button with the check mark to acknowledge the alarm.

See Rockwell Automation Library of Process Objects: Common Alarm Block (P_Alarm) Reference Manual, publication [SYSLIB-RM002](#), for more information.

Discrete Input - Faceplate Help

Digital Input Faceplate Help 

Status Indicators

 Invalid Configuration	 Alarm Inhibit (Suppressed or Disabled)
 Communication Failure	 Maintenance Bypass Active
 Communication Uncertain	 Device in Simulation or Test
 Input matches Target	 Input does not match Target

Alarms 

Discrete Input Alarm

This alarm triggers when the Input Process Variable is not equal to the Target Process Variable and the Gate value is Enabled.

Rockwell Automation Support

Rockwell Automation provides technical information on the Web to assist you in using its products.

At <http://www.rockwellautomation.com/support> you can find technical and application notes, sample code, and links to software service packs. You can also visit our Support Center at <https://rockwellautomation.custhelp.com/> for software updates, support chats and forums, technical information, FAQs, and to sign up for product notification updates.

In addition, we offer multiple support programs for installation, configuration, and troubleshooting. For more information, contact your local distributor or Rockwell Automation representative, or visit <http://www.rockwellautomation.com/services/online-phone>.

Installation Assistance

If you experience a problem within the first 24 hours of installation, review the information that is contained in this manual. You can contact Customer Support for initial help in getting your product up and running.

United States or Canada	1.440.646.3434
Outside United States or Canada	Use the Worldwide Locator at http://www.rockwellautomation.com/rockwellautomation/support/overview.page , or contact your local Rockwell Automation representative.

New Product Satisfaction Return

Rockwell Automation tests all of its products to help ensure that they are fully operational when shipped from the manufacturing facility. However, if your product is not functioning and needs to be returned, follow these procedures.

United States	Contact your distributor. You must provide a Customer Support case number (call the phone number above to obtain one) to your distributor to complete the return process.
Outside United States	Please contact your local Rockwell Automation representative for the return procedure.

Documentation Feedback

Your comments will help us serve your documentation needs better. If you have any suggestions on how to improve this document, complete this form, publication [RA-DU002](#), available at <http://www.rockwellautomation.com/literature/>.

Rockwell Automation maintains current product environmental information on its website at <http://www.rockwellautomation.com/rockwellautomation/about-us/sustainability-ethics/product-environmental-compliance.page>.

Rockwell Otomasyon Ticaret A.Ş., Kar Plaza İş Merkezi E Blok Kat:6 34752 İçerenköy, İstanbul, Tel: +90 (216) 5698400

www.rockwellautomation.com

Power, Control and Information Solutions Headquarters

Americas: Rockwell Automation, 1201 South Second Street, Milwaukee, WI 53204-2496 USA, Tel: (1) 414.382.2000, Fax: (1) 414.382.4444
Europe/Middle East/Africa: Rockwell Automation NV, Pegasus Park, De Kleetlaan 12a, 1831 Diegem, Belgium, Tel: (32) 2 663 0600, Fax: (32) 2 663 0640
Asia Pacific: Rockwell Automation, Level 14, Core F, Cyberport 3, 100 Cyberport Road, Hong Kong, Tel: (852) 2887 4788, Fax: (852) 2508 1846

Publication SYSLIB-RM003F-EN-E - January 2016

Supersedes Publication SYSLIB-RM003E-EN-E - August 2014

Copyright © 2016 Rockwell Automation, Inc. All rights reserved. Printed in the U.S.A.