



---

*Allen-Bradley*

# **F-Series**

## **Brushless Servo Motor Manual**

**Rockwell**  
**Automation**

Bringing Together Leading Brands in Industrial Automation

## Use of Motors

Servo motors are intended to drive machinery. As such, they must be part of a controlled system that includes a transistorized electronic amplifier. They are not intended for direct connection to the power supply or for use with thyristor drives. Instructions in the amplifier and control system manuals must be observed; this document does not replace those instructions.

Unless specified otherwise, servo motors are intended for use in a normal industrial environment without exposure to excessive or corrosive moisture or abnormal ambient temperatures. The exact operating conditions may be established by referring to the data for the motor. The mating of motors to machinery is a skilled operation; disassembly or repair must not be attempted. In the event that a motor fails to operate correctly, contact the place of purchase for return instructions.

## Safety Notes

There are some possible hazards associated with the use of motors. The following precautions should be observed. Specific Warnings and Cautions are listed inside the back cover.

**Installation and Maintenance:** Installation and maintenance or replacement must be carried out by suitably qualified service personnel, paying particular attention to possible electrical and mechanical hazards.

**Weight:** Large motors are generally heavy, and the center of gravity may be offset. When handling, take appropriate precautions and use suitable lifting equipment. Beware of sharp edges; use protective gloves when handling such assemblies.

**Flying leads:** Ensure that flying or loose leads are suitably restrained, to prevent snagging or entanglement, before carrying motors with such leads.

**Generation:** If the motor is driven mechanically, it may generate hazardous voltages at its power input terminals. The power connector must be suitably guarded to prevent a possible shock hazard.

**Loose motors:** When running an unmounted motor, ensure that the rotating shaft is adequately guarded and the motor is physically restrained to prevent it from moving. Remove the key which otherwise could fly out when the motor is running.

**Damaged cables:** Damage to cables or connectors may cause an electrical hazard. Ensure there is no damage before energizing the system.

**Supply:** Servo motors must not be directly connected to a power supply; they require an electronic drive system. Consult the instructions for the drive system before energizing or using the motor.

**Brakes:** The brakes that are included on motors are holding brakes only and are not to be used as a mechanical restraining device for safety purposes.

**Safety requirements:** The safe incorporation of this product into a machine system is the responsibility of the machine designer, who should comply with the local safety requirements at the place where the machine is to be used. In Europe this is likely to be the Machinery Directive.

**Mechanical connection:** Motors must be connected to the machine with a torsionally rigid coupler or a reinforced timing belt. Couplers which are not rigid will cause difficulty in achieving an acceptable response from the control system. Couplings and pulleys must be tight as the high dynamic performance of a servo motor can easily cause couplings to slip, and thereby damage the shaft and cause instability. Care must be taken in aligning couplings and tightening belts so that the motor is not subjected to significant bearing loads, or premature bearing wear will occur. Once connected to a load, tuning will be affected. A system tuned without a load will probably require retuning once a load is applied.

**Connectors:** Motor power connectors are for assembly purposes only. They should not be connected or disconnected while power is applied.

© 1999 Rockwell International Corporation. All rights reserved.

Allen-Bradley is a trademark of Rockwell Automation.

Printed in the United States of America.

Information contained in this manual is subject to change without notice.

# Motor Data

MOTOR MODEL		F-4030	F-4050	F-4075	F-6100	F-6200	F-6300
<b>MECHANICAL DATA (1)</b>							
Rotor Moment of Inertia	kg-m <sup>2</sup>	.0010	.0021	.0032	.0064	.0107	.0162
	lb-in-s <sup>2</sup>	.009	.019	.029	.057	.095	.144
Rotor Moment of Inertia Brake Motors	kg-m <sup>2</sup>	.0011	.0022	.0033	.007	.011	.017
	lb-in-s <sup>2</sup>	.010	.020	.030	.061	.098	.147
Motor Shipping Weight	kg	10.4	15.8	21.4	25.1	27.5	45.8
	lb	23	34.8	47.2	55.4	73.8	101
Motor Shipping Weight Brake Motors	kg	12.5	17.8	23.9	29.9	38.3	51.3
	lb	27.6	39.2	52.6	66	84.4	113
Damping	Nm/krpm	.06	.10	.15	.16	.24	.37
	lb-in/krpm	.5	.94	1.3	1.4	2.1	3.3
Friction Torque	Nm	.063	.11	.17	.17	.24	.46
	lb-in	.56	.94	1.5	1.5	2.1	4.1
Max. Operating Speed	rpm	4000	4000	3000	3000	3000	3000
<b>WINDING DATA (1)</b>							
Poles		8	8	8	8	8	8
Sine Wave K <sub>T</sub>	Nm/A	.54	.54	.73	.71	.70	.73
	lb-in/A	4.8	4.8	6.5	6.3	6.2	6.5
Torque Constant (2)							
Square Wave K <sub>T</sub>	Nm/A	.60	.60	.80	.78	.80	.81
	lb-in/A	5.3	5.3	7.1	6.9	6.8	7.1
Torque Constant (3)							
K <sub>E</sub> Voltage Constant (4)	V/krpm	66	66	89	86	85	89
Winding Resistance Phase to Phase at 25±5°C	Ohms ±15%	2.24	.89	.98	.51	.26	.16
Winding Inductance Phase to Phase	mH	6.8	3.3	3.4	3.3	1.7	1.1
Thermal Resistance	°C/Watt	.63	.48	.40	.45	.37	.30
Dielectric Rating	Power Leads (R, S, T) to Ground: 1500 VACrms 50/60 Hz for 1 minute.						
(1) Specifications are at 25°C unless otherwise noted.				(3) Peak value of per phase square wave Amperes			
(2) Peak value of per phase sine wave Amperes				(4) Peak value of sinusoidal phase to phase Volts			

## STORAGE AND OPERATING CONDITIONS

Ambient Temperature	Operating: 0 to 40°C (32 to 104°F) Storage: -30 to 70°C (-25 to 158°F)
Relative Humidity	5% to 95% non-condensing

# Thermostat Specifications

## THERMOSTAT RATINGS

Rated Voltage	0 - 250 Volts DC or 50/60 Hz AC*
Rated Current	2.5 Amps @ Power Factor of 1.0 1.6 Amps @ Power Factor of 0.6
Maximum Switching Current	5 Amps
Contact Resistance	<0.10 Ohms maximum
Contacts	Normally closed
Insulation Dielectric	Mylar Nomex capable of withstanding 1500 VAC RMS 50/60 Hz for 1 minute
Opening Temperature (±5°C)	140°C
* The thermostat is normally used as a switch for a 15VDC logic signal.	

# Dimensional Data

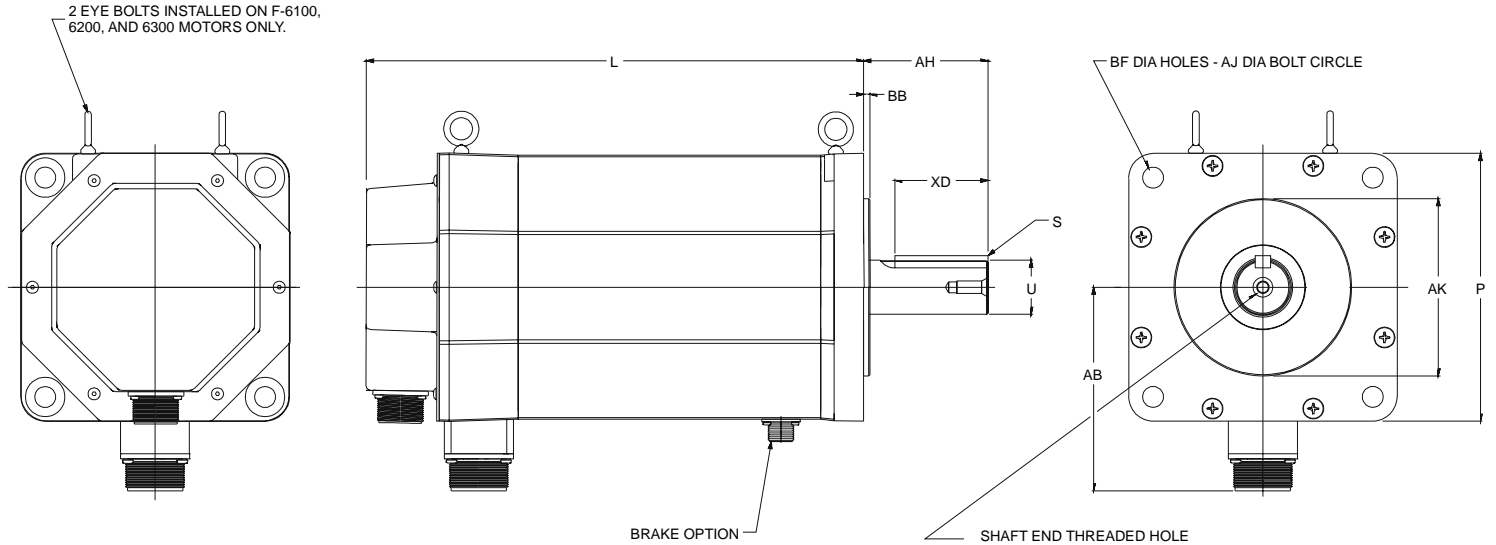

**SHAFTE END PLAY UNDER LOAD**

Maximum End Play (All Motors)		Load Applied to Shaft	
Direction	mm/in	Motor Series	Kg/Lb
→ <b>A</b>	0.025/0.001	F-4000	9.07/20.0
← <b>B</b>	0.254/0.010	F-6000	22.68/50.0

NOTE: End play and load are measured in inches and pounds. Metric measurements are approximate conversions from inches and pounds.

**SHAFTE END THREADED HOLE**

Motor Series	Thread	Thread/Depth
F-4000	M6 x 1.0mm	15mm/.59in
F-6000	M8 x 1.25mm	20mm/.79

Note: Motors are manufactured to millimeter dimensions. Inch dimensions are approximate conversions from millimeters.

# Motor Dimensions

MOTOR DIMENSIONS																
Motor Model	AB	AH	AJ	AK	BB	BF	EP	L	L with Brake	P	S	U	XD	Tolerances		
	mm/in	mm/in	mm/in	mm/in	mm/in	mm/in	mm/in	mm/in	mm/in	mm/in	mm/in	mm/in	mm/in	mm	inches	
F-4030	102/4.02	50/1.97 (1)	145/5.71	110/4.33 (2)	3/12 (3)	10/.39 (4)	22.2/875 (6)	194/7.64	257/10.12	127/5.00	6x6/.24x.24	19/.75 (8)	38/1.49	1	±0.500	±0.0196
F-4050								272/10.71	335/13.19					2	-0.035	-0.0013
F-4075								350/13.78	413/16.26					3	-0.013	-0.0005
F-6100	131/5.16	80/3.15 (1)	200/7.87	114.3/4.50 (2)	4/.16 (3)	13.5/53 (5)	36.5/1.438 (7)	255/10.04	326/12.83	173/6.81	10x8/.39x.32	35/1.38 (9)	60/2.36	4	-0.016	-0.0006
F-6200								320/12.60	390/15.35					5	-0.035	-0.0013
F-6300								420/16.53	490/19.29					6	-0.100	-0.0039
														7	-0.050	-0.0019
														8	-0.013	-0.0005
														9	-0.016	-0.0006

NOTE: Motors are manufactured to millimeter dimensions. Inch dimensions are approximate conversions from millimeters.

SUPPLEMENTAL MOTOR DIMENSIONS													
Length, from motor faceplate to center of connectors													
CONNECTOR	F-4030	BRAKE	F-4050	BRAKE	F-4075	BRAKE	F-6100	BRAKE	F-6200	BRAKE	F-6300	BRAKE	
BRAKE (mm/in)	—	56/22.0	—	56/22.0	—	56/22.0	—	59/23.2	—	59/23.2	—	59/23.2	
ENCODER (mm/in)	126/49.6	189/74.4	204/80.3	267/105.1	282/111.0	345/135.8	183/72.0	254/100.0	248/97.6	318/125.2	348/137.0	418/164.6	
POWER (mm/in)	172/67.7	235/92.5	250/98.4	313/123.2	228/89.8	301/118.5	233/91.7	304/119.7	298/117.3	368/144.9	398/156.7	468/184.2	

# Connector Data

All F-Series Motors Encoder	
Pin	Signal
A	A+
B	A-
C	B+
D	B-
E	I+
F	I-
G	ENCODER CASE
H	ABS
J	+5VDC
K	+5VDC
L	COM
M	COM
N	HALL B
P	HALL C
R	TS+
S	TS-
T	HALL A

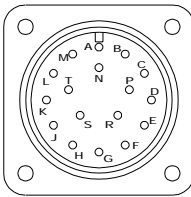

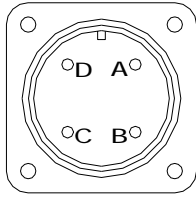

MIL-SPEC part numbers	
F-4000	Power MS3102A-20-4P
F-6000	Power MS3102A-24-22P

All F-Series Motors Power	
Pin	Signal
A	R
B	S
C	T
D	MOTOR CASE

Brake (option)	
Pin	Signal
A	BR+
B	BR-

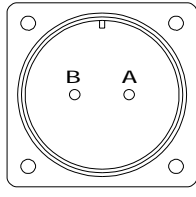
MIL-SPEC part numbers	
All F-Series:	Encoder MS3102A20-29P
	Brake MS-3102A-12S-3P

# Options: Connectors and Shaft Seals

MS Connector Part Numbers and Threaded Coupling Ring Torque Recommendations			
Type	MS Part Number	lb-in	Nm
Brake	MS3102A-12S-3P	34 - 40	3.8 - 4.5
Power	MS3102A-18-4P	70 - 75	7.9 - 8.5
	MS3102A-20-4P	80 - 85	9.0 - 9.6
Encoder	MS3102A-20-29	100 - 110	11.3 - 12.4
	MS3102A-24-22P		
	MS3102A-32-17P	150 - 160	16.9 - 18.1

The F-Series motor has an IP65 rating, when coupled with environmentally sealed Military Specification (MS) cable assemblies and when an optional shaft seal is installed. Equipment rated as IP65 provides protection against the ingress of dust and water projected by a nozzle (jet) from any direction. An IP65 rating is roughly equivalent to a NEMA 12 enclosure type rating. The IP65 rating applies for any orientation of motor mounting, but it is recommended to mount the motor so the connectors project down. If cable assemblies are used that are not environmentally sealed, the motor is rated IP40, with or without the optional shaft seal. With environmentally sealed cable assemblies and no optional shaft seal the motor rating is as follows: Motor mounted horizontally; IP51. Motor mounted shaft up; IP50. Motor mounted shaft down; IP53.

# Shaft Seal Kits

Shaft seals protect the motor and its bearings against dust or water entering through the shaft opening.

MOTOR SEAL KITS		
MOTOR SERIES	PART NUMBER	SIZE (O Dia x I Dia x Width)
F-4000	0041-5060	1.437" x 0.875" x 0.25" (36mm x 22mm x 6mm)
F-6000	0041-5061	2.125" x 1.438" x 0.31" (54mm x 37mm x 8mm)

NOTE: Shaft seals are manufactured to inch dimensions. Millimeter dimensions are conversions from inches. Shaft seals require a lubricant to reduce wear.

# MS Connector Kits

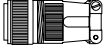
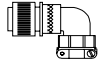
MOTOR POWER CONNECTORS				
	STRAIGHT	MOTOR SERIES	RIGHT ANGLE	
	9101-0326 (MS3106F20-4S)	F-4000	9101-0399 (MS3108F20-4S)	
	9101-0327 (MS3106F24-22S)	F-6000	9101-0400 (MS3108F24-22S)	

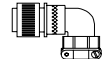
BRAKE POWER CONNECTORS	
	STRAIGHT
	9101-0330 (MS3106F12S-3S)
	RIGHT ANGLE
	9101-0403 (MS3108F12-3S)

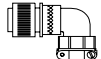
ENCODER FEEDBACK CONNECTORS	
	STRAIGHT
	9101-0329 (MS3106F20-29S)
	RIGHT ANGLE
	9101-0402 (MS3108F20-29S)

# Wire and Contact Sizing Recommendations

The following connector contact sizes and minimum wiring gages are recommended for cabling to a motor.

POWER CONNECTOR		
MOTOR	CONTACT AWG(mm <sup>2</sup> )	WIRE AWG(mm <sup>2</sup> )
F-4030	12 (3.0)	16 (1.5)
F-4050		14 (2.5)
F-4075		
F-6100	8 (8.6)	12 (4)
F-6200		8 (10)
F-6300		

Sizes are recommended minimum values for 4 conductors (R, S, T and GND). Wiring should be twisted. Local regulations should always be observed.

ENCODER CONNECTOR	
CONTACT AWG(mm <sup>2</sup> )	WIRE AWG(mm <sup>2</sup> )
All F-Series 16 (1.5)	24 (0.25) with ULTRA Plus 22 (0.34) with ULTRA 100-200 Drives

BRAKE CONNECTOR	
CONTACT AWG(mm <sup>2</sup> )	WIRE AWG(mm <sup>2</sup> )
16 (1.5)	18 (0.75)
Recommended minimum mechanical size. Local regulations should always be observed.	

Factory manufactured power cables and encoder cables are available in standard cable lengths of 10, 25, 50 and 75 feet (3, 7.6, 15 and 23 meters).

# F-4000 Series NEMA 56C Motors

Dimensions	Without Brake	With Brake
Motors	in/mm	in/mm
F-4030 NEMA 56C	7.64/194	10.12/257
F-4050 NEMA 56C	10.71/272	13.19/335
F-4075 NEMA 56C	13.79/350	16.26/413

Note:  
NEMA 56C motors are manufactured to inch dimensions. Millimeter dimensions are approximate conversions from inches.

SUPPLEMENTAL MOTOR DIMENSIONS			
Length, from motor faceplate to center of connectors			
Motors	Brake (in/mm)	Power (in/mm)	Encoder (in/mm)
F-4030	—	4.97/12.6	6.77/17.2
F-4030 BRAKE	2.21/5.6	7.45/18.9	9.25/23.5
F-4050	—	8.04/20.4	9.84/25.0
F-4050 BRAKE	2.21/5.6	10.52/26.7	12.32/31.3
F-4075	—	11.12/28.2	12.92/32.8
F-4075 BRAKE	2.21/5.6	13.59/34.5	15.39/39.1

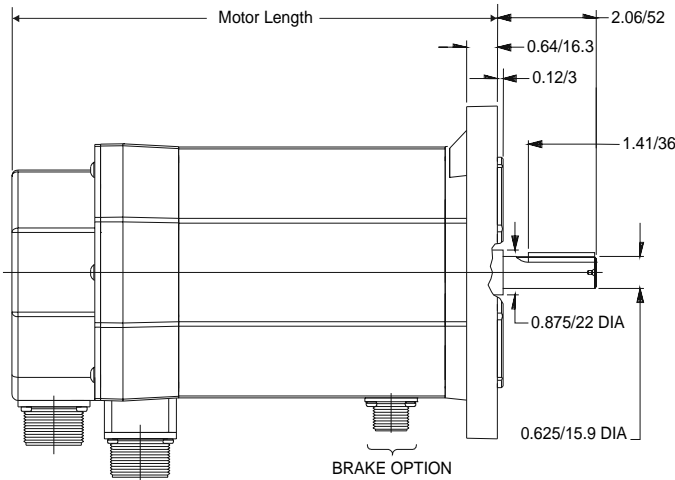

MOTOR WILL ACCEPT 1.437 INCH X 0.875 INCH  
0.25 INCH SHAFT SEAL (OPTIONAL, NOT  
INCLUDED, RELIANCE P/N 0041-5060)

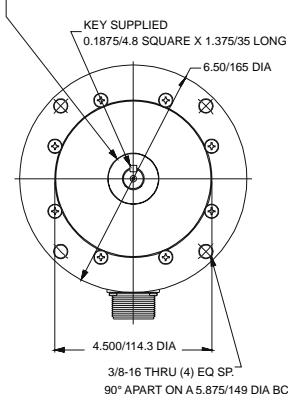



# Encoder Data

Encoders are factory aligned and must not be adjusted outside the factory.

ENCODER SPECIFICATIONS	
Line Count	2000 (1)
Supply Voltage	5 VDC
Supply Current	250 mA max.
Line Driver	26LS31
Line Driver Output	TTL
Index Pulse	F-2000 and F-3000 Series when key faces $180^{\circ} \pm 10$ away from the connectors
	F-4000, F-6000 and F-8000 Series when key faces the connectors ( $0^{\circ} \pm 10$ )

(1) Standard line count before quadrature

## Encoder Outputs

ENCODER OUTPUT

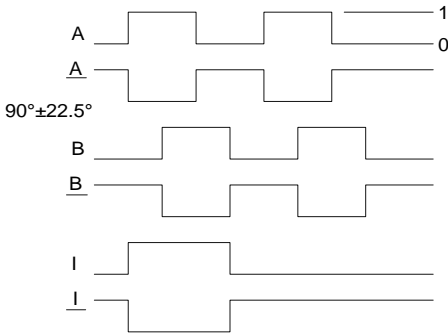

WAVEFORMS RESULT FROM CW SHAFT ROTATION  
(CLOCKWISE AS VIEWED FACING THE SHAFT EXTENSION)

## Encoder Phase-to-Neutral and Phase-to-Phase Waveforms

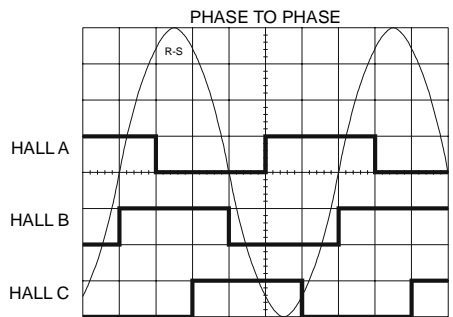
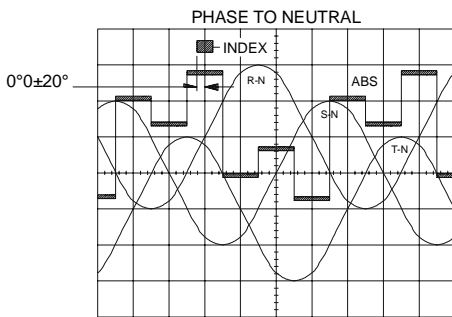

NOTE: Hall and ABS signals are in electrical degrees.

For 4 pole commutation, 360° mechanical = 720° electrical.

For 6 pole commutation, 360° mechanical = 1080° electrical.

For 8 pole commutation, 360° mechanical = 1440° electrical

# Motor Radial Load Force Ratings

Motors are capable of carrying an axial load in most applications. The following table provides guidelines for 20,000 hour bearing life with a specified radial load applied to the center of the shaft. Please consult with Rockwell Automation regarding loads, operating speeds and bearing life in your particular application to ensure the proper selection of motors.

STANDARD RADIAL LOAD FORCE RATINGS					
MOTOR	500 rpm lb (kg)	1000 rpm lb (kg)	2000 rpm lb (kg)	3000 rpm lb (kg)	4000 rpm lb (kg)
F-4030	76 (34)	60 (27)	47 (21)	41 (19)	38 (17)
F-4050	88 (40)	69 (31)	55 (25)	48 (22)	44 (20)
F-4075	92 (42)	73 (33)	58 (26)	51 (23)	46 (21)
F-6100	159 (72)	126 (57)	100 (45)	87 (39)	
F-6200	172 (78)	136 (62)	108 (49)	94 (43)	
F-6300	183 (83)	145 (66)	115 (52)	101 (46)	

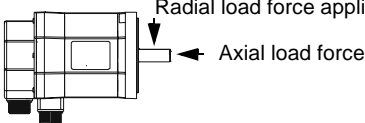

Radial load force applied at center of shaft extension

Axial load force

NOTE: When motor shaft has no radial load, axial load rating = 100% of radial load rating above.  
When motor shaft has both a radial load and an axial load, axial load rating = 44% of radial load rating above.

# Brake Motor Application Guidelines

The brakes offered as options on these servo motors are holding brakes. They are designed to hold the motor shaft at 0 rpm for up to the rated brake holding torque. The brakes are spring-set type, and release when voltage is applied to the brake coil.

The brakes are *not* designed for stopping rotation of the motor shaft. Servo drive inputs should be used to stop motor shaft rotation. The recommended method of stopping motor shaft rotation is to command the servo drive to decelerate the motor to 0 rpm, and engage the brake after the servo drive has decelerated the motor to 0 rpm.

If system main power fails, the brakes can withstand use as stopping brakes. However, use of the brakes as stopping brakes creates rotational mechanical backlash that is potentially damaging to the system, increases brake pad wear and reduces brake life. The brakes are *not* designed nor are they intended to be used as a safety device.

A separate power source is required to disengage the brake. This power source may be controlled by the servo motor controls, in addition to manual operator controls.

# Brake Specifications

BRAKE DATA					
MOTOR SERIES	MAX. BACKLASH (Brake Engaged)	HOLDING TORQUE		COIL CURRENT	
		(lb/in)	(Nm)	at 24 VDC	at 90 VDC
F-4000	44 minutes	90	10.2	0.69 ADC	0.20 ADC
F-6000	29 minutes	275	31.1	1.30 ADC	0.48 ADC

# Motor Installation

Observe the following installation guidelines and those in the Product Notice:



---

**ATTENTION:** Motors and linkages must be securely mounted for a system to be operational. Disassembled equipment should be appropriately identified (tagged-out) and access to electrical power restricted (locked-out).

Failure to observe these safety procedures could result in personal injury and damage to equipment.

---

1. Do not run motors that are not properly mounted. Attach all power and data cables after the motor is mounted.
2. Mount motors with connectors pointing downward and use a drip loop in the cable to keep liquids flowing away from the connectors.
3. Consider motor case temperature if necessary to safeguard operator and maintenance staff. Maximum case temperature is approximately 100°C (212°F) for a motor used at continuous rating in a 40°C ambient temperature.
4. The installer must comply with all local regulations and should use equipment and installation practices that promote electromagnetic compatibility and safety.

## Preventing Electrical Noise

ElectroMagnetic Interference (EMI), commonly called “noise”, may adversely impact motor performance by inducing stray signals. Effective techniques to counter EMI include filtering the AC power, shielding and separating signal carrying lines, and practicing good grounding techniques. Effective AC power filtering can be achieved through the use of isolated AC power transformers or properly installed AC line filters. Physically separate signal lines from motor cabling and power wiring; do *not* parallel signal wires with motor or power wires or route signal wires over the vent openings of servo drives. Ground all equipment using a single-point parallel ground system that employs ground bus bars or straps. If necessary, use electrical noise remediation techniques to mitigate EMI in “noisy” environments.

Knowledgeable cable routing and careful cable construction improves system electromagnetic compatibility (EMC). General cable build and installation guidelines include:

1. Keep wire lengths as short as physically possible.
2. Route signal cables (encoder, serial, analog) away from motor and power wiring.
3. Separate cables by 1 foot minimum for every 30 feet of parallel run.
4. Ground both ends of the encoder cable and twist the signal wire pairs.
5. Use shielded motor cables when necessary to prevent electromagnetic interference (EMI) with other equipment.

## Couplings and Pulleys

Mechanical connections to the motor shaft, such as couplings and pulleys, require a rigid coupling or a reinforced timing belt. The high dynamic performance of servo motors can cause couplings, pulleys or belts to loosen or slip over time. A loose or slipping connection will cause system instability and may damage the motor shaft and keyway. All connections between the system and the servo motor shaft must be rigid to achieve acceptable response from the system. Connections should be periodically inspected to verify the rigidity.

When mounting couplings or pulleys to the motor shaft, ensure that the connections are properly aligned and that axial and radial loads are within the specifications of the motor. The section “Load Force Ratings” provides guidelines to achieve 20,000 hours of bearing life. Additional information about load force ratings, including graphical depiction of varied load ratings and bearing life, is available for any motor from the Technical Support groups listed on the back cover.

# Product Information

## Motor Part Number Identification

**F - 4030 - Q - H 00 AA**

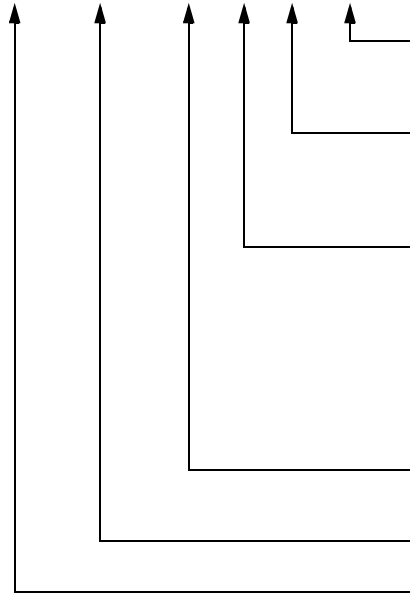

### FACTORY DESIGNATED SPECIAL OPTIONS

AA = STANDARD FLANGE

AN = NEMA 56C FLANGE

### OPTIONS

00 = STANDARD

01 = 90 VDC BRAKE

04 = 24 VDC BRAKE

### OPTICAL ENCODER LINE COUNT

F = 1000

H = 2000 (STANDARD)

J = 2500

K = 5000

L = F-Series 00

M = 3000

N = 2000

### MOTOR WINDING K<sub>E</sub> VOLTAGE DESIGNATOR

NOTE: Special order windings available

### FRAME SIZE

### SERIES DESIGNATOR

F = Medium inertia

## Disposal or Warranty Return of Motors

Motors may contain environmentally regulated materials, such as lead solder and circuit boards. When disposing of a motor, please recycle motors per regulations at your location. You may choose to return a motor for disposal by contacting your supplier.

Please contact the source that supplied the motor for warranty, non-warranty, or disposal work. All returned products require a Return Material Authorization (RMA) number for efficient processing and tracking.

For more information refer to our web site: [www.ab.com/motion](http://www.ab.com/motion)

[www.rockwellautomation.com](http://www.rockwellautomation.com)

### Power, Control and Information Solutions Headquarters

Americas: Rockwell Automation, 1201 South Second Street, Milwaukee, WI 53204-2496 USA, Tel: (1) 414.382.2000, Fax: (1) 414.382.4444

Europe/Middle East/Africa: Rockwell Automation, Vorstlaan/Boulevard du Souverain 36, 1170 Brussels, Belgium, Tel: (32) 2 663 0600, Fax: (32) 2 663 0640

Asia Pacific: Rockwell Automation, Level 14, Core F, Cyberport 3, 100 Cyberport Road, Hong Kong, Tel: (852) 2887 4788, Fax: (852) 2508 1846