

Continuous Flex Feedback Cables

Catalog Numbers 2090-CFBM4DF-CDAFxx, 2090-XXTFMP-Sxx

Topic	Page
About Continuous Flex Cables	1
Installing Cables	3
Specifications, Schematics, and Connector Pinouts for Cables	6
Catalog Number 2090-CFBM4DF-CDAFxx Flying Lead	7
Catalog Number 2090-XXTFMP-Sxx Flying Lead	8

Overview

This document provides general cable handling and installation information, and cable schematics with wire color and connector pinouts. This information is useful when connecting feedback cables to Kinetix Motion Control products.

About Continuous Flex Cables

Flex cables have an identifiable region, the flex zone, in which the cable can flex many times without breakage. This contrasts with non-flex cables that are limited to a one-time bend.

Important User Information

Solid state equipment has operational characteristics differing from those of electromechanical equipment. Safety Guidelines for the Application, Installation and Maintenance of Solid State Controls (Publication SGI-1.1 available from your local Rockwell Automation sales office or online at <http://literature.rockwellautomation.com>) describes some important differences between solid state equipment and hard-wired electromechanical devices. Because of this difference, and also because of the wide variety of uses for solid state equipment, all persons responsible for applying this equipment must satisfy themselves that each intended application of this equipment is acceptable.





In no event will Rockwell Automation, Inc. be responsible or liable for indirect or consequential damages resulting from the use or application of this equipment.

The examples and diagrams in this manual are included solely for illustrative purposes. Because of the many variables and requirements associated with any particular installation, Rockwell Automation, Inc. cannot assume responsibility or liability for actual use based on the examples and diagrams.

No patent liability is assumed by Rockwell Automation, Inc. with respect to use of information, circuits, equipment, or software described in this manual.

Reproduction of the contents of this manual, in whole or in part, without written permission of Rockwell Automation, Inc., is prohibited.

Throughout this manual, when necessary, we use notes to make you aware of safety considerations.

WARNING	Identifies information about practices or circumstances that can cause an explosion in a hazardous environment, which may lead to personal injury or death, property damage, or economic loss.
	
IMPORTANT	Identifies information that is critical for successful application and understanding of the product.
ATTENTION	Identifies information about practices or circumstances that can lead to personal injury or death, property damage, or economic loss. Attentions help you identify a hazard, avoid a hazard and recognize the consequences.
	
SHOCK HAZARD	Labels may be on or inside the equipment, for example, a drive or motor, to alert people that dangerous voltage may be present.
	
BURN HAZARD	Labels may be on or inside the equipment, for example, a drive or motor, to alert people that surfaces may reach dangerous temperatures.
	

The Kinetix Motion Control Selection Guide, publication [GMC-SG001](#), also contains specifications, as well as information on cable compatibility with specific drives and motors.

Refer to these drive manuals for specific examples on how to use the cables in this document to interface between your drive and motor.

Resource	Description
Kinetix 2000 Multi-axis Servo Drive User Manual, publication 2093-UM001	Provides mounting, wiring, and application-based information for a Kinetix multi-axis or an Ultra single-axis servo drive system and its components.
Kinetix 6000 Multi-axis Servo Drive User Manual, publication 2094-UM001	
Kinetix 7000 High Power Servo Drive User Manual, publication 2099-UM001	
Ultra1500 Digital Servo Amplifiers User Manual, publication 2092-UM001	
Ultra3000 Digital Servo Drive Installation Manual, publication 2098-IN003 or Integration Manual, publication 2098-IN005	
Ultra5000 Intelligent Positioning Drives Installation Manual, publication 2098-IN001	

These publications are available from your local Rockwell Automation sales office or online at <http://literature.rockwellautomation.com>.

Installing Cables

Cables are stored and shipped in a coil, and retain this shape unless you allow the cable to straighten itself. To straighten a cable, hang a short cable from its mid-point or lay a long cable on the floor in a straight line. Any coiling that persists in the cable should relax within the next twenty-four hours. Doing this results in a cable that is easier to install.

WARNING



Arcing or unexpected motion could occur if the power, brake, or feedback cables are connected or disconnected while power is applied to the servo drive.

Always remove power to the servo drive before connecting or disconnecting cables at the drive, or disconnecting a cable at the motor.

Failure to observe these safety procedures could result in personal injury or damage to the motor and equipment.

WARNING



To avoid the hazard of electrical shock, ensure shielded power cables are grounded at a minimum of one point. To prevent the build-up of electrical energy, factory-supplied power cables use one of these grounding techniques:

- The overall shield is bonded to the connector housing.
- A section of the overall shield is exposed for connection to ground.
- The overall shield is connected to a ground wire.

If the exposed cable braid or a ground wire is present, it should be connected to the power cable clamp, housing, or another suitable chassis ground on the drive.

Failure to observe these safety procedures could result in personal injury or equipment damage.

ATTENTION



The examples in this publication show all the available connections, some of which may not be appropriate for your specific installation. Refer to your drive installation or user manual for recommended wire trim lengths, and wiring examples appropriate to your drive and motor application.

Do not connect unused wires. Unused wires may be trimmed and finished as necessary to prevent accidental contact with other wires or wire shields, or with a ground connection.

Failure to observe these safety procedures could result in personal injury or damage to the motor and equipment.

You must provide the recommended installation areas, and the correct offset from features, before beginning any cable bend. Features include connectors, transitions from exposed wires to insulated areas (for example, flying leads), or exposed cable ground shields. The offset from these areas should be greater than or equal to ($\geq 1x$) the cable diameter.

Cable Flex Zone and Installation Areas with Bend Restrictions

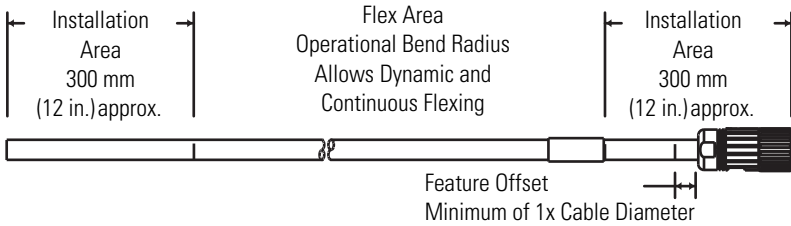

2090-CFBM4DF-CDAF-xxAFxx shown

Cables have a specified bend radius, and should not be bent with a radius that is tighter than the specified bend radius. General guidelines for the bend radius of a cable are listed below, however individual cables may have other restrictions:

- Non-flex cables have a static or one-time bend radius of ten times (10x) the cable diameter.
- Flex cables have an operational bend radius of twelve times (12x) the cable diameter.

You may identify each connection on a cable by attaching a label around the outer insulation of each wire adjacent to the drive connection.

Specifications, Schematics, and Connector Pinouts for Cables

These specifications provide information that is useful when installing a cable. Additional specifications for each cable are available in the Kinetix Motion Control Selection Guide, publication [GMC-SG001](#).

Specifications for Continuous Flex Feedback Cables

Attribute	Value
Catalog Numbers	2090-CFBM4DF-CDAF _{xx} , 2090-XXTFMP-S _{xx}
Diameter	9.7 mm
Bend Radius ⁽¹⁾	
• Flex Area	120 mm (5 in.)
• Installation Areas ⁽²⁾	100 mm (4 in.),

⁽¹⁾ Apply the multiplier for operational (12 x dia.) and static (10 x dia.) bend radius to cables with a different diameter. Refer to the diagram to locate the areas for flex (operational), and static (installation) bend areas.

⁽²⁾ The installation area is an area approximately 300 mm (12 in.) in length at both ends of the cable. Secure this area with a rigid mount that prevents the cable from flexing where it connects to other components.

The schematics include wire colors, connector pinouts, and other information that is useful when connecting the cable to a servo system.

Catalog Number 2090-CFBM4DF-CDAFxx Flying Lead

This cable is available in several wire gauges and lengths. Refer to the Kinetix Motion Control Selection Guide, publication [GMC-SG001](#), for this information and additional specifications.

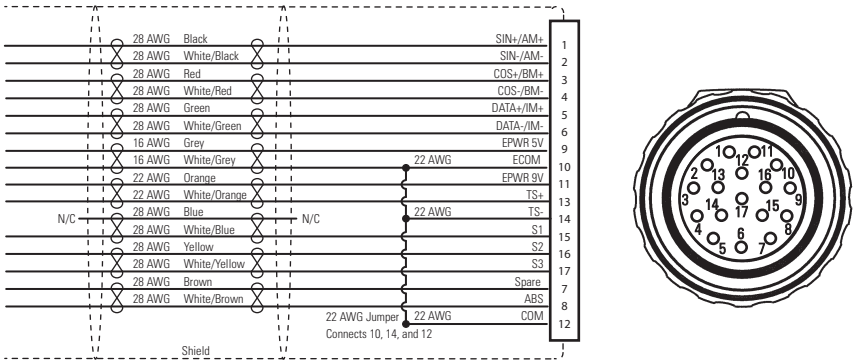

360° shield-to-ground connection required.

Twisted Pairing of Wires
 Shield
 • Wire Connection
 Heatshrink insulates wire-to-wire connections.

Motor connector backshell shielded 360°.

- 1 Feedback connector on the bulletin 2098 drives is labeled CN2, and MF on bulletin 2093 or 2094 drives.
- 2 If necessary to fit a connector, add a 22 AWG wire to EPWR_5V, or ECOM (16 AWG) at the flying lead. Make the connection less than 38.1 mm (1.5 in.) from the termination point of the cable, and insulate it with shrink tubing.
- 3 Terminate the overall cable braid to a connector housing or to an appropriate termination on the device.

Catalog Number 2090-XXTFMP-Sxx Flying Lead

This cable is available in several wire gauges and lengths. Refer to the Kinetix Motion Control Selection Guide, publication [GMC-SG001](#), for this information and additional specifications.

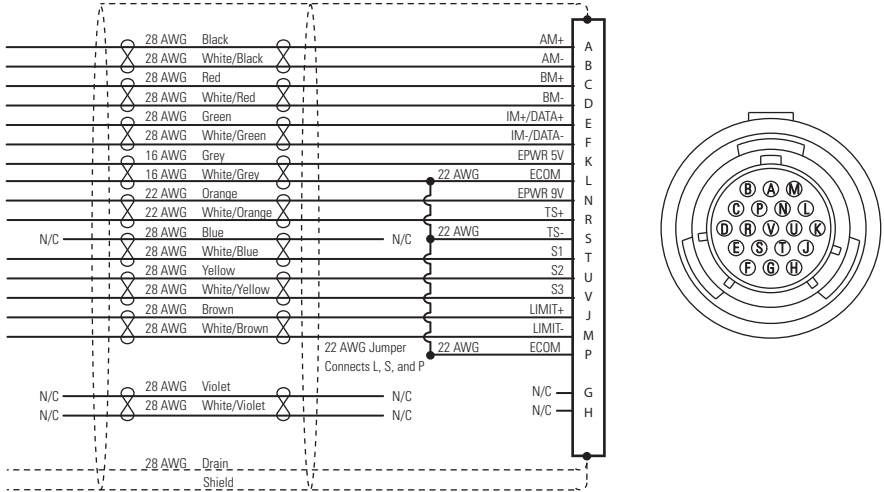

↙ 360° shield-to-ground connection required.

⊗ Twisted Pairing of Wires
 ⊘ Shield
 ● Heatshrink insulates wire-to-wire connections.

↖ Motor connector backshell shielded 360°.

- 1 Feedback connector on the bulletin 2098 drives is labeled CN2, and MF on bulletin 2093 or 2094 drives.
- 2 If necessary to fit a connector, add a 22 AWG wire to EPWR_5V, or ECOM (16 AWG) at the flying lead. Make the connection less than 38.1 mm (1.5 in.) from the termination point of the cable, and insulate it with shrink tubing.
- 3 Terminate the overall cable braid to a connector housing or to an appropriate termination on the device.

Allen-Bradley, Kinetix, Rockwell Automation, Ultra1500, and Ultra 5000 are trademarks of Rockwell Automation, Inc. Trademarks not belonging to Rockwell Automation are property of their respective companies.

www.rockwellautomation.com

Power, Control and Information Solutions Headquarters

Americas: Rockwell Automation, 1201 South Second Street, Milwaukee, WI 53204-2496 USA, Tel: (1) 414.382.2000, Fax: (1) 414.382.4444
 Europe/Middle East/Africa: Rockwell Automation, Vorstlaan/Boulevard du Souverain 36, 1170 Brussels, Belgium, Tel: (32) 2 663 0600, Fax: (32) 2 663 0640

Publication 2090-PC003A-EN-P - June 2008

PN-25076

Copyright © 2008 Rockwell Automation, Inc. All rights reserved. Printed in the U.S.A.