

Precision Limit Switch

Catalog Numbers 802B

IMPORTANT SAVE THESE INSTRUCTIONS FOR FUTURE USE.

This publication does not include specifications, dimensions, and other installation considerations. Refer to our website (<http://ab.rockwellautomation.com/>) for additional information.



WARNING: To avoid electrical shock and/or unintended operation of equipment, disconnect all power to the limit switch and the controlled equipment before proceeding with any repair or adjustment of the limit switch.

Overview

Limit Switches are used in electrical control systems to sense position. They are actuated by the predetermined motion of a cam, machine component, or piece part. This mechanical motion is then converted to an electrical signal through the actuation of a set of contacts. These signals can be used in the control circuits of solenoids, control relays, and motor starters to control the operation of conveyors, hoists, elevators, machine tools, etc. They are not to be used to directly control a motor.

General Data

- Enclosure Rating:
 - Nonbooted: NEMA 1 and IP60
 - Booted: NEMA 1, 3, 4 and IP65
- Mechanical Life: Approximately 10,000,000 operations¹
- Electrical Life: Approximately 500,000 operations (15A 250V AC, resistive load)¹
- Operating Speed
 - Top Push: 0.01...500 mm (0.0004...19.68 in.) per second
 - Lever Type: 0.02...500 mm (0.0008...19.68 in.) per second
- Operating Frequency:
 - Mechanical: 120 operations/minute
 - Electrical: 20 operations/minute
- Operating Temperature: -10...80°C (14...176°F) with no icing
- Short Circuit Protection: Quick blow fuse suitable for rated current is recommended.

¹ Life expectancy has been calculated at an operating temperature of 5...35°C (41...95°F) and an operating humidity of 40...70%.

Mounting

Units should be mounted using the mounting holes provided. These mounting holes are located on the sides of the side limit switches and on the flange of the flange mounted limit switches. All side mounted limit switches come with two #6 mounting screws. To ensure proper sealing around the mounting screws, always use the O-rings and washers provided.

Mounting Torque Specifications

Hardware	Torque
Terminal Screws	0.78...1.18 N·m (6.9...10.44 lb·in)
Cover Mounting Screw	1.18...1.37 N·m (10.44...12.12 lb·in)
Lever Tightening Nut	4.9...5.88 N·m (43.37...52.04 lb·in)
Switch Mounting Screw (side/flange mounting)	1.18...1.37 N·m (10.44...12.12 lb·in)
Connector/Conduit	1.80...2.20 N·m (15.93...19.47 lb·in)

Roller Arm Adjustments

1. The roller arm may be adjusted freely within a range of 225°. This may be accomplished by loosening nut #1.
2. The roller arm may also be rotated 360° by loosening nut #2.

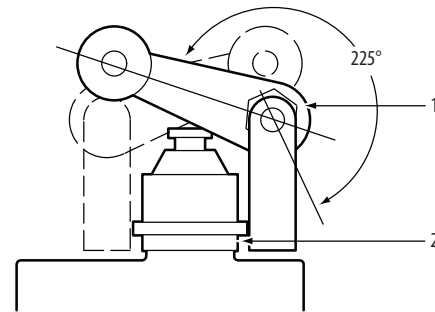

Wiring

- Grounding of switch should be achieved per NEC requirements. Grounding terminal is located in switch cover.
- Arrange control wiring according to terminal markings.
- Tighten terminal screws according to specifications.
- Only use insulated connectors.

Actuation Consideration

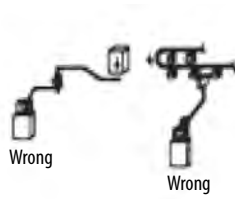

Limit switches are designed for proper performance with the actuators with which they are supplied. Supplementary actuators should not be used unless the limit switches are specifically designed for them.

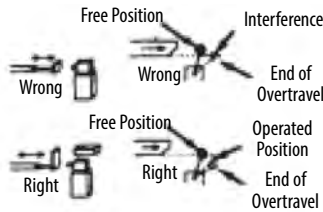

Operating mechanism for limit switches should be so designed that under any operating or emergency conditions, the limit switch is not operated beyond its overtravel limit position. A limit switch should not be used as a mechanical stop.

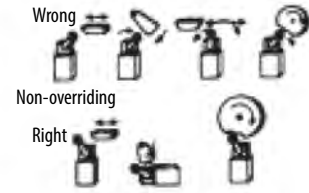

For limit switches with lever actuators, the actuating force should be applied as nearly perpendicular to the lever as practical and perpendicular to the shaft axis about which the lever rotates.

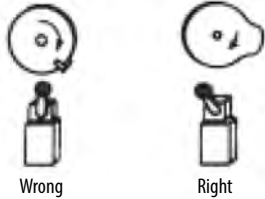

Where relatively fast motions are involved, cam arrangements should be such that the actuator does not receive a severe impact. Cams should be designed such that the limit switch will be held operated long enough to operate relays, valves, etc.

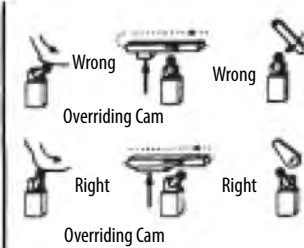

Cam or dog arrangements should be such that the actuator is not suddenly released to snap back freely.

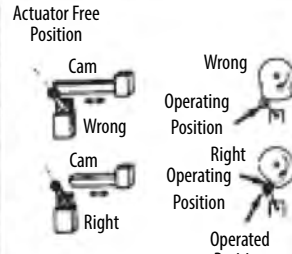

A limit switch actuator must be allowed to move far enough for positive operation of the contacts.

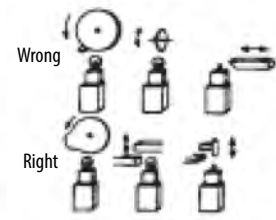

For limit switches with pushrod actuators the actuating force should be applied as nearly as possible in line with the pushrod axis.

Location and Installation

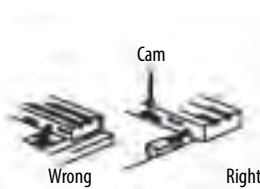

Limit switches should be mounted rigidly and in readily accessible locations with suitable clearances to permit easy service and replacement when necessary. Cover plates should face the maintenance access point.

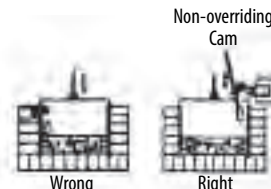

Limit switches should not be used in locations where temperature or atmosphere conditions are beyond those for which they have been specifically designed.

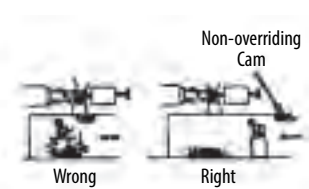

Limit switches should be placed in locations where machining chips do not accumulate under normal operating conditions

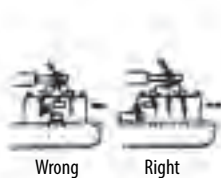

Limit switches should not be submerged in or splashed with oils, coolants, or other liquids.

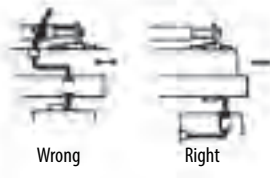

The location of oiltight limit switches and the method of connecting them should be such that condensation in the conduit cannot enter the switch enclosure.

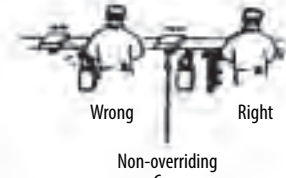

Limit switches should be mounted in locations which would prevent false operation by normal movements of operator or machine components.

Rockwell Automation maintains current product environmental information on its website at

<http://www.rockwellautomation.com/rockwellautomation/about-us/sustainability-ethics/product-environmental-compliance.page>.

Allen-Bradley, Rockwell Automation, and Rockwell Software are trademarks of Rockwell Automation, Inc. Trademarks not belonging to Rockwell Automation are property of their respective companies.

Rockwell Otomasyon Ticaret A.Ş., Kar Plaza İş Merkezi E Blok Kat:6 34752 İçerenköy, İstanbul, Tel: +90 (216) 5698400

www.rockwellautomation.com

Power, Control and Information Solutions Headquarters

Americas: Rockwell Automation, 1201 South Second Street, Milwaukee, WI 53204-2496 USA, Tel: (1) 414.382.2000, Fax: (1) 414.382.4444

Europe/Middle East/Africa: Rockwell Automation NV, Pegasus Park, De Kleetlaan 12a, 1831 Diegem, Belgium, Tel: (32) 2 663 0600, Fax: (32) 2 663 0640

Asia Pacific: Rockwell Automation, Level 14, Core F, Cyberport 3, 100 Cyberport Road, Hong Kong, Tel: (852) 2887 4788, Fax: (852) 2508 1846

Publication 802B-IN003A-EN-P - February 2001

75043-003-01 (B)

Copyright © 2001 Rockwell Automation, Inc. All rights reserved. Printed in the U.S.A.