



## FLEX 5000 EtherNet/IP Adapters with SFP Support

Catalog Numbers 5094-AENSFPR, 5094-AENSFPRXT, 5094-AEN2SFPR, 5094-AEN2SFPRXT

Topic	Page
Summary of Changes	1
Product Overview	1
About the Adapter	4
Set the Network Internet Protocol (IP) Address	7
Install the Adapter onto the DIN Rail	7
Install an SFP Module	8
Connect Power to the Adapter	8
Connect the Adapter to an EtherNet/IP Network	10
Power the System	11
Remove or Replace the Adapter	12
Specifications	13
Additional Resources	15

### Summary of Changes

This publication contains the following new or updated information. This list includes substantive updates only and is not intended to reflect all changes.

Topic	Page
Updated template	throughout
Updated trademarks	1
Updated UK and European Hazardous Location Approval	3
Updated IEC Hazardous Location Approval	3
Updated Special Conditions for Safe Use	3
Updated Module Specifications	13...14

### Product Overview

- The FLEX 5000<sup>®</sup> I/O EtherNet/IP<sup>™</sup> Adapters with SFP Support perform the following functions:
  - Support fiber or copper small form-factor pluggable (SFP) modules<sup>(a)</sup> via two SFP slots.
  - Facilitate high-speed data transfer across an EtherNet/IP network between FLEX 5000 I/O modules and a Logix 5000<sup>®</sup> controller.
  - Provide system-side power to FLEX 5000 I/O modules.
  - The 5094-AENSFPR and 5094-AENSFPRXT adapters support as many as 8 FLEX 5000 I/O modules.
  - The 5094-AEN2SFPR and 5094-AEN2SFPRXT adapters support as many as 16 FLEX 5000 I/O modules.

The adapters are configured with the Studio 5000 Logix Designer<sup>®</sup> application. For more information on how to use FLEX 5000 EtherNet/IP Adapters with SFP Support, including the compatible Logix 5000 controllers, and Logix Designer application versions, see the publications that are listed in [Additional Resources on page 15](#).

(a) You must purchase SFP modules separately. For a list of supported SFP modules, see [Supported SFP modules on page 14](#). For SFP module specifications, see Stratix<sup>®</sup> Ethernet Device Specifications Technical Data, publication 1783-TD002.



**ATTENTION:** Read this document and the documents listed in the Additional Resources section about installation, configuration and operation of this equipment before you install, configure, operate or maintain this product. Users are required to familiarize themselves with installation and wiring instructions in addition to requirements of all applicable codes, laws, and standards.

Activities including installation, adjustments, putting into service, use, assembly, disassembly, and maintenance are required to be carried out by suitably trained personnel in accordance with applicable code of practice.

If this equipment is used in a manner not specified by the manufacturer, the protection provided by the equipment may be impaired.

注意：在安装、配置、操作和维护本产品前，请阅读本文档以及“其他资源”部分列出的有关设备安装、配置和操作的相应文档。除了所有适用规范、法律和标准的相关要求之外，用户还必须熟悉安装和接线说明。

安装、调整、投运、使用、组装、拆卸和维护等各项操作必须由经过适当训练的专业人员按照适用的操作规范实施。

如果未按照制造商指定的方式使用该设备，则可能会损害设备提供的保护。

**ATENCIÓN:** Antes de instalar, configurar, poner en funcionamiento o realizar el mantenimiento de este producto, lea este documento y los documentos listados en la sección Recursos adicionales acerca de la instalación, configuración y operación de este equipo. Los usuarios deben familiarizarse con las instrucciones de instalación y cableado y con los requisitos de todos los códigos, leyes y estándares vigentes.

El personal debidamente capacitado debe realizar las actividades relacionadas a la instalación, ajustes, puesta en servicio, uso, ensamblaje, desensamblaje y mantenimiento de conformidad con el código de práctica aplicable.

Si este equipo se usa de una manera no especificada por el fabricante, la protección provista por el equipo puede resultar afectada.

**ATENÇÃO:** Leia este e os demais documentos sobre instalação, configuração e operação do equipamento que estão na seção Recursos adicionais antes de instalar, configurar, operar ou manter este produto. Os usuários devem se familiarizar com as instruções de instalação e fiação além das especificações para todos os códigos, leis e normas aplicáveis.

É necessário que as atividades, incluindo instalação, ajustes, colocação em serviço, utilização, montagem, desmontagem e manutenção sejam realizadas por pessoal qualificado e especializado, de acordo com o código de prática aplicável.

Caso este equipamento seja utilizado de maneira não estabelecida pelo fabricante, a proteção fornecida pelo equipamento pode ficar prejudicada.

**ВНИМАНИЕ:** Перед тем как устанавливать, настраивать, эксплуатировать или обслуживать данное оборудование, прочитайте этот документ и документы, перечисленные в разделе «Дополнительные ресурсы». В этих документах изложены сведения об установке, настройке и эксплуатации данного оборудования. Пользователи обязаны ознакомиться с инструкциями по установке и прокладке соединений, а также с требованиями всех применимых норм, законов и стандартов.

Все действия, включая установку, наладку, ввод в эксплуатацию, использование, сборку, разборку и техническое обслуживание, должны выполняться обученным персоналом в соответствии с применимыми нормами и правилами.

Если оборудование используется не предусмотренным производителем образом, защита оборудования может быть нарушена.

注意：本製品を設置、構成、稼働または保守する前に、本書および本機器の設置、設定、操作についての参考資料の該当箇所に記載されている文書に目を通してください。ユーザは、すべての該当する条例、法律、規格の要件に加えて、設置および配線の手順に習熟している必要があります。

設置調整、運転の開始、使用、組立て、解体

、保守を含む諸作業は、該当する実施規則に従って訓練を受けた適切な作業員が実行する必要があります。

本機器が製造メーカーにより指定されていない方法で使用されている場合、機器により提供されている保護が損なわれる恐れがあります。

**ACHTUNG:** Lesen Sie dieses Dokument und die im Abschnitt „Weitere Informationen“ aufgeführten Dokumente, die Informationen zu Installation, Konfiguration und Bedienung dieses Produkts enthalten, bevor Sie dieses Produkt installieren, konfigurieren, bedienen oder warten. Anwender müssen sich neben den Bestimmungen aller anwendbaren Vorschriften, Gesetze und Normen zusätzlich mit den Installations- und Verdrahtungsanweisungen vertraut machen.

Arbeiten im Rahmen der Installation, Anpassung, Inbetriebnahme, Verwendung, Montage, Demontage oder Instandhaltung dürfen nur durch ausreichend geschulte Mitarbeiter und in Übereinstimmung mit den anwendbaren Ausführungsvorschriften vorgenommen werden.

Wenn das Gerät in einer Weise verwendet wird, die vom Hersteller nicht vorgesehen ist, kann die Schutzfunktion beeinträchtigt sein.

**ATTENTION :** Lisez ce document et les documents listés dans la section Ressources complémentaires relatifs à l'installation, la configuration et le fonctionnement de cet équipement avant d'installer, configurer, utiliser ou entretenir ce produit. Les utilisateurs doivent se familiariser avec les instructions d'installation et de câblage en plus des exigences relatives aux codes, lois et normes en vigueur.

Les activités relatives à l'installation, le réglage, la mise en service, l'utilisation, l'assemblage, le démontage et l'entretien doivent être réalisées par des personnes formées selon le code de pratique en vigueur.

Si cet équipement est utilisé d'une façon qui n'a pas été définie par le fabricant, la protection fournie par l'équipement peut être compromise.

주의: 본 제품 설치, 설정, 작동 또는 유지 보수하기 전에 본 문서를 포함하여 설치, 설정 및 작동에 관한 참고 자료 섹션의 문서들을 반드시 읽고 숙지하십시오. 사용자는 모든 관련 규정, 법규 및 표준에서 요구하는 사항에 대해 반드시 설치 및 배선 지침을 숙지해야 합니다.

설치, 조정, 가동, 사용, 조립, 분해, 유지보수 등 모든 작업은 관련 규정에 따라 적절한 교육을 받은 사용자를 통해서만 수행해야 합니다.

본 장비를 제조사가 명시하지 않은 방법으로 사용하면 장비의 보호 기능이 손상될 수 있습니다.

**ATTENZIONE** Prima di installare, configurare ed utilizzare il prodotto, o effettuare interventi di manutenzione su di esso, leggere il presente documento ed i documenti elencati nella sezione "Altre risorse", riguardanti l'installazione, la configurazione ed il funzionamento dell'apparecchiatura. Gli utenti devono leggere e comprendere le istruzioni di installazione e cablaggio, oltre ai requisiti previsti dalle leggi, codici e standard applicabili.

Le attività come installazione, regolazioni, utilizzo, assemblaggio, disassemblaggio e manutenzione devono essere svolte da personale adeguatamente addestrato, nel rispetto delle procedure previste.

Qualora l'apparecchio venga utilizzato con modalità diverse da quanto previsto dal produttore, la sua funzione di protezione potrebbe venire compromessa.

**DİKKAT:** Bu ürünü kurulumu, yapılandırılması, işletilmesi veya bakımı öncesinde bu dokümanı ve bu ekipmanın kurulumu, yapılandırılması ve işletimi ile ilgili ilave Kaynaklar bölümünde yer listelenmiş dokümanları okuyun. Kullanıcılar yürürlükteki tüm yönetmelikler, yasalar ve standartların gereksinimlerine ek olarak kurulum ve kablolama talimatlarını da öğrenmek zorundadır.

Kurulum, ayarlama, hizmet alma, kulllanma, parçaları birleştirme, parçaları sökme ve bakım gibi aktiviteler sadece uygun eğitimli almış kişiler tarafından yürürlükteki uygulama yönetmeliklerine uygun şekilde yapılabilir.

Bu ekipman üretici tarafından belirlenmiş amacın dışında kullanılırsa, ekipman tarafından sağlanan koruma bozulabilir.

注意事項：在安装、設定、操作或維護本產品前，請先閱讀此文件以及列於「其他資源」章節中有關安裝、設定與操作此設備的文件。使用者必須熟悉安裝和配線指示，並符合所有法規、法律和標準要求。

包括安裝、調整、交付使用、使用、組裝、拆卸和維護等動作都必須交由已經適當訓練的人員進行，以符合適用的實作法規。

如果將設備用於非製造商指定的用途時，可能會造成設備所提供的保護功能受損。

**POZOR:** Než začnete instalovat, konfigurovat či provozovat tento výrobek nebo provádět jeho údržbu, přečtěte si tento dokument a dokumenty uvedené v části Dodatečné zdroje ohledně instalace, konfigurace a provozu tohoto zařízení. Uživatelé se musejí vedle požadavků všech relevantních vyhlášek, zákonů a norem nutně seznámit také s pokyny pro instalaci a elektrické zapojení.

Činnosti zahrnující instalaci, nastavení, uvedení do provozu, užívání, montáž, demontáž a údržbu musí vykonávat vhodné proškolený personál v souladu s příslušnými prováděcími předpisy.

Pokud se toto zařízení používá způsobem neodpovídajícím specifikaci výrobce, může být narušena ochrana, kterou toto zařízení poskytuje.

**UWAGA:** Przed instalacją, konfiguracją, użytkowaniem lub konserwacją tego produktu należy przeczytać niniejszy dokument oraz wszystkie dokumenty wymienione w sekcji Dodatkowe źródła omawiające instalację, konfigurację i procedury użytkowania tego urządzenia. Użytkownicy mają obowiązek zapoznać się z instrukcjami dotyczącymi instalacji oraz oprzewodowania, jak również z obowiązującymi kodeksami, prawem i normami.

Działania obejmujące instalację, regulację, przekazanie do użytkowania, użytkowanie, montaż, demontaż oraz konserwację muszą być wykonywane przez odpowiednio przeszkolony personel, zgodnie z obowiązującym kodeksem postępowania.

Jeśli urządzenie jest użytkowane w sposób inny niż określony przez producenta, zabezpieczenie zapewniane przez urządzenie może zostać ograniczone.

**OBBS:** Läs detta dokument samt dokumentet, som står listat i avsnittet Övriga resurser, om installation, konfigurering och drift av denna utrustning innan du installerar, konfigurerar eller börjar använda eller utföra underhållsarbete på produkten. Användare måste bekanta sig med instruktioner för installation och kabeldragning, förutom krav enligt gällande koder, lagar och standarder.

Åtgärder som installation, justering, service, användning, montering, demontering och underhållsarbete måste utföras av personal med lämplig utbildning enligt lämpligt bruk.

Om denna utrustning används på ett sätt som inte anges av tillverkaren kan det hända att utrustningens skyddsanordningar försätts ur funktion.

**LET OP:** Lees dit document en de documenten die genoemd worden in de paragraaf Aanvullende informatie over de installatie, configuratie en bediening van deze apparatuur voordat u dit product installeert, configureert, bedient of onderhoudt. Gebruikers moeten zich vertrouwd maken met de installatie en de bedragsinstructies, naast de vereisten van alle toepasselijke regels, wetten en normen.



Activiteiten zoals het installeren, afstellen, in gebruik stellen, gebruiken, monteren, demonteren en het uitvoeren van onderhoud mogen uitsluitend worden uitgevoerd door hiervoor opgeleid personeel en in overeenstemming met de geldende praktijkregels.

Indien de apparatuur wordt gebruikt op een wijze die niet is gespecificeerd door de fabrikant, dan bestaat het gevaar dat de beveiliging van de apparatuur niet goed werkt.



**WARNING:** For Class I Division 2 applications, use only Class I Division 2 listed or recognized accessories and modules approved for use within the 5094 platform. When used in a Class I Division 2, hazardous location, this equipment must be mounted in a suitable enclosure with proper wiring method that complies with the governing electrical codes.

**North American Hazardous Location Approval**

This information applies when operating this equipment in hazardous locations.	Informations sur l'utilisation de cet équipement en environnements dangereux.
<p>Products marked "CL I, DIV 2, GP A, B, C, D" are suitable for use in Class I Division 2 Groups A, B, C, D, Hazardous Locations and nonhazardous locations only. Each product is supplied with markings on the rating nameplate indicating the hazardous location temperature code. When combining products within a system, the most adverse temperature code (lowest "T" number) may be used to help determine the overall temperature code of the system. Combinations of equipment in your system are subject to investigation by the local Authority Having Jurisdiction at the time of installation.</p>	<p>Les produits marqués "CL I, DIV 2, GP A, B, C, D" ne conviennent qu'à une utilisation en environnements de Classe I Division 2 Groupes A, B, C, D dangereux et non dangereux. Chaque produit est livré avec des marquages sur sa plaque d'identification qui indiquent le code de température pour les environnements dangereux. Lorsque plusieurs produits sont combinés dans un système, le code de température le plus défavorable (code de température le plus faible) peut être utilisé pour déterminer le code de température global du système. Les combinaisons d'équipements dans le système sont sujettes à inspection par les autorités locales qualifiées au moment de l'installation.</p>
<div style="display: flex; align-items: center;">  <div> <p><b>WARNING: EXPLOSION HAZARD</b></p> <ul style="list-style-type: none"> <li>Do not disconnect equipment unless power has been removed or the area is known to be nonhazardous.</li> <li>Do not disconnect connections to this equipment unless power has been removed or the area is known to be nonhazardous. Secure any external connections that mate to this equipment by using screws, sliding latches, threaded connectors, or other means provided with this product.</li> <li>Substitution of components may impair suitability for Class I Division 2.</li> </ul> </div> </div>	<div style="display: flex; align-items: center;">  <div> <p><b>WARNING: AVERTISSEMENT: RISQUE D'EXPLOSION</b></p> <ul style="list-style-type: none"> <li>Couper le courant ou s'assurer que l'environnement est classé non dangereux avant de débrancher l'équipement.</li> <li>Couper le courant ou s'assurer que l'environnement est classé non dangereux avant de débrancher les connecteurs. Fixer tous les connecteurs externes reliés à cet équipement à l'aide de vis, loquets coulissants, connecteurs filetés ou autres moyens fournis avec ce produit.</li> <li>La substitution de composants peut rendre cet équipement inadapté à une utilisation en environnement de Classe I Division 2.</li> </ul> </div> </div>

**UK and European Hazardous Location Approval**

<p>The following applies to products marked  <b>II 3 G</b>:</p> <ul style="list-style-type: none"> <li>Are Equipment Group II, Equipment Category 3, and comply with the Essential Health and Safety Requirements relating to the design and construction of such equipment given in Schedule 1 of UKEX and Annex II to EU Directive 2014/34/EU. See the UKEX and EU Declaration of Conformity at <a href="http://rok.auto/certifications">rok.auto/certifications</a> for details.</li> <li>The type of protection is Ex ec IIC T4 Gc according to EN IEC 60079-0:2018, EXPLOSIVE ATMOSPHERES - PART 0: EQUIPMENT - GENERAL REQUIREMENTS and EN IEC 60079-7:2015+A1:2018, Explosive atmospheres - Equipment protection by increased safety "e".</li> <li>Comply with Standard EN IEC 60079-0:2018, EXPLOSIVE ATMOSPHERES - PART 0: EQUIPMENT - GENERAL REQUIREMENTS, EN IEC 60079-7:2015+A1:2018 Explosive atmospheres - Equipment protection by increased safety "e", reference certificate number DEMK017ATEX1898X &amp; UL22UKEX2654X.</li> <li>Are intended for use in areas in which explosive atmospheres caused by gases, vapors, mists, or air are unlikely to occur, or are likely to occur only infrequently and for short periods. Such locations correspond to Zone 2 classification according to UKEX regulation 2016 No. 1107 and ATEX directive 2014/34/EU.</li> </ul>
---

**IEC Hazardous Location Approval**

<p>The following applies to products with IECEx certification: Such modules:</p> <ul style="list-style-type: none"> <li>Are intended for use in areas in which explosive atmospheres caused by gases, vapors, mists, or air are unlikely to occur, or are likely to occur only infrequently and for short periods. Such locations correspond to Zone 2 classification to IEC 60079-0.</li> <li>The type of protection is Ex ec IIC T4 Gc according to IEC 60079-0 and IEC 60079-7.</li> <li>Comply with Standards IEC 60079-0, Explosive atmospheres Part 0: Equipment - General requirements, Edition 7, Revision Date 2017, IEC 60079-7, 5.1 Edition revision date 2017, Explosive atmospheres - Part 7: Equipment protection by increased safety "e", reference IECEx certificate number IECEx UL17.0047X.</li> </ul>
--

<div style="display: flex; align-items: center;">  <div> <p><b>WARNING: Special Conditions for Safe Use:</b></p> <ul style="list-style-type: none"> <li>This equipment shall be mounted in an UKEX/ATEX/IECEx Zone 2 certified enclosure with a minimum ingress protection rating of at least IP54 (in accordance with EN/IEC 60079-0) and used in an environment of not more than Pollution Degree 2 (as defined in EN/IEC 60664-1) when applied in Zone 2 environments. The enclosure must be accessible only by the use of a tool.</li> <li>This equipment shall be used within its specified ratings defined by Rockwell Automation.</li> <li>Transient protection shall be provided that is set at a level not exceeding 140% of the peak rated voltage value at the supply terminals to the equipment.</li> <li>The instructions in the user manual shall be observed.</li> <li>This equipment must be used only with UKEX/ATEX/IECEx certified Rockwell Automation backplanes.</li> <li>Secure any external connections that mate to this equipment by using screws, sliding latches, threaded connectors, or other means provided with this product.</li> <li>Do not disconnect equipment unless power has been removed or the area is known to be nonhazardous.</li> <li>The installer shall ensure that the service temperature of the suitably certified enclosure and the "maximum ambient" temperature of the module when installed is not exceeded.</li> </ul> </div> </div>
---

**Prevent Electrostatic Discharge**

<div style="display: flex; align-items: center;">  <div> <p><b>ATTENTION:</b> This equipment is sensitive to electrostatic discharge, which can cause internal damage and affect normal operation. Follow these guidelines when you handle this equipment:</p> <ul style="list-style-type: none"> <li>Touch a grounded object to discharge potential static.</li> <li>Wear an approved grounding wriststrap.</li> <li>Do not touch connectors or pins on component boards.</li> <li>Do not touch circuit components inside the equipment.</li> <li>Use a static-safe workstation, if available.</li> <li>Store the equipment in appropriate static-safe packaging when not in use.</li> </ul> </div> </div>
--

**Electrical Safety Considerations**



**ATTENTION:**

- All wiring must comply with applicable electrical installation requirements [N.E.C. article 501-4(b)].
- Wire conductor and insulation ratings shall support minimum temperature rating of 105 °C (221 °F).
- Do not wire more than one conductor on any terminal.
- In case of malfunction or damage, no attempts at repair should be made. The module should be returned to the manufacturer for repair. Do not dismantle the module.
- This equipment is certified for use only within the surrounding air temperature range of -40...+70 °C (-40...+158 °F). The equipment must not be used outside of this range.
- Use only a soft dry anti-static cloth to wipe down equipment. Do not use any cleaning agents.

**Environment and Enclosure**



**ATTENTION:** This equipment is intended for use in a Pollution Degree 2 industrial environment, in overvoltage Category II applications (as defined in EN/IEC 60664-1), at altitudes up to 2000 m (6562 ft) without derating. This equipment is not intended for use in residential environments and may not provide adequate protection to radio communication services in such environments.

This equipment is supplied as open-type equipment for indoor use. It must be mounted within an enclosure that is suitably designed for those specific environmental conditions that will be present and appropriately designed to help prevent personal injury resulting from accessibility to live parts. The enclosure must have suitable flame-retardant properties to help prevent or minimize the spread of flame, complying with a flame spread rating of 5VA or be approved for the application if nonmetallic. The interior of the enclosure must be accessible only by the use of a tool. Subsequent sections of this publication may contain additional information regarding specific enclosure type ratings that are required to comply with certain product safety certifications.

In addition to this publication, see the following:

- Industrial Automation Wiring and Grounding Guidelines, publication [1770-4.1](#), for more installation requirements.
- NEMA Standard 250 and EN/IEC 60529, as applicable, for explanations of the degrees of protection provided by enclosures.



**ATTENTION:** Personnel responsible for the application of safety-related programmable electronic systems (PES) shall be aware of the safety requirements in the application of the system and shall be trained in using the system.

**IMPORTANT** Any illustrations, charts, sample programs, and layout examples shown in this publication are intended solely for the purposes of example. Since there are many variables and requirements associated with any particular installation, Rockwell Automation does not assume responsibility or liability for actual use based on the examples shown in this publication.

**About the Adapter**

Figure 1 - FLEX 5000 EtherNet/IP Adapter with SFP Support

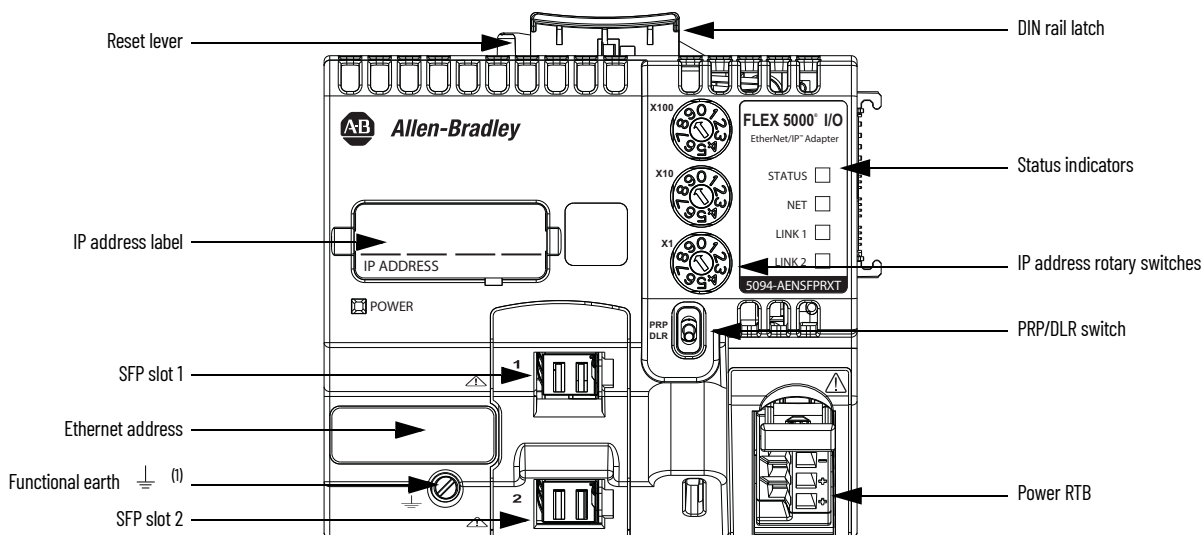

(1) Functional earth must be grounded. See [Ground Considerations on page 6](#) for more information.

**IMPORTANT** The PRP feature is available from firmware revision 4.011 or later. If you are using an earlier firmware revision, the adapter cannot establish connection with I/O modules when the PRP/DLR switch is in the PRP position.

## Required Components

To install the adapter, you need the physical components that are listed in the following table.

### Components Needed to install a FLEX 5000 EtherNet/IP Adapter with SFP Support

Component	Description
Removable terminal block (RTB)	Your adapter comes with a screw-type RTB. You can order screw-type or spring-type RTBs separately: <ul style="list-style-type: none"> <li>• 5094-AENRTB-QTY5 - 5094 Adapter RTB Screw -Pack of 5</li> <li>• 5094-AENRTBS-QTY5 - 5094 Adapter RTB Spring -Pack of 5</li> </ul>
Small form-factor pluggable (SFP) module	You must purchase SFP modules separately. For a list of supported SFP modules, see <a href="#">Supported SFP modules on page 14</a> . For SFP module specifications, see Stratix Ethernet Device Specifications Technical Data, publication <a href="#">1783-TD002</a> .
External power supply for module power	A power supply that is adequately sized to provide module power, that is, system-side power, to the FLEX 5000 I/O system. For more information, see <a href="#">System Power Considerations on page 6</a> .
End cap	A backplane end cap ships with a FLEX 5000 EtherNet/IP adapter. You can order backplane end caps separately: 5094-ECR-QTY5 - End cap, pack of 5
Tools	The following tools are needed: <ul style="list-style-type: none"> <li>• Screwdriver</li> <li>• Wire stripper</li> <li>• Wires</li> </ul> For more information about available wire sizes and wire insulation-stripping length, see <a href="#">Specifications on page 13</a> .
DIN rail	Compatible zinc-plated chromate-passivated steel DIN rail. You can use a steel DIN rail such as the Allen-Bradley® 199-DR1; 46277-3; EN60715 - 35 x 7.5 mm (1.38 x 0.30 in.).
EtherNet/IP network components	You must install the network and all required components.
Software	If you do not use the rotary switches to set the adapter IP address, you can use the following software to set the IP address: <ul style="list-style-type: none"> <li>• DHCP server</li> <li>• BOOTP DHCP EtherNet/IP Commissioning Tool</li> <li>• RSLinx® Classic software</li> </ul> For more information, see <a href="#">Set the Network Internet Protocol (IP) Address on page 7</a> .

## System Planning

Follow these rules when planning your system configuration:

- The adapter is the leftmost module in the rack.
- Local FLEX 5000 I/O modules are installed to the right of the adapter.
- The 5094-AENSFPR and 5094-AENSFPRXT adapters support as many as 8 FLEX 5000 I/O modules.
- The 5094-AEN2SFPR and 5094-AEN2SFPRXT adapters support as many as 16 FLEX 5000 I/O modules.
- Before powerup, verify that the end cap is installed on the right-most FLEX 5000 terminal base in the system.



**ATTENTION:** Do not discard the end cap. Use this end cap to cover the exposed interconnections on the adapter or the last terminal base on the DIN rail. Failure to do so could result in equipment damage or injury from electric shock. See [Install the End Cap on page 11](#) for more information.

## Spacing

Maintain spacing from enclosure walls, wireways, and adjacent equipment. You can mount the DIN rail horizontally or vertically.

Figure 2 - FLEX 5000 EtherNet/IP Adapter with SFP Support Spacing

### Horizontal Mounting

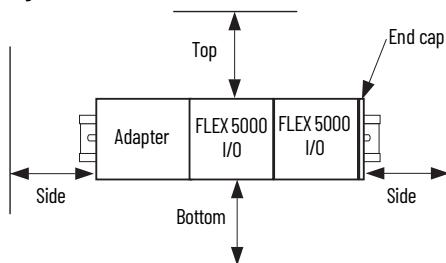

### Vertical Mounting

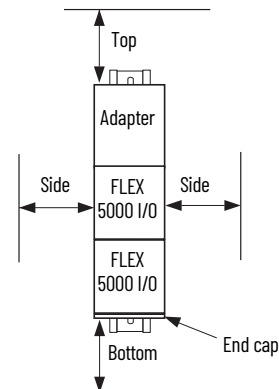

**IMPORTANT:** Allow 25.4 mm (1.00 in.) of space on all sides of the system for adequate ventilation.

## Dimensions

Figure 3 - FLEX 5000 EtherNet/IP Adapter with SFP Support Dimensions

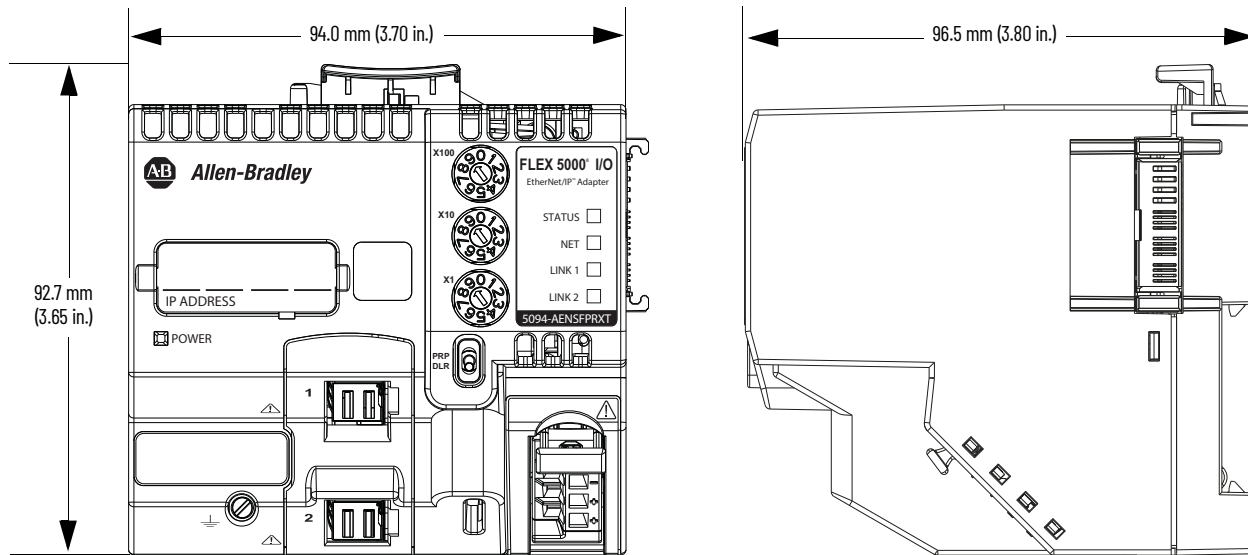

## Ground Considerations

You must ground DIN rails according to the Industrial Automation Wiring and Grounding Guidelines, publication [1770-4.1](#).



**ATTENTION:** This product is grounded through the DIN rail to chassis ground. Use zinc-plated chromate-passivated steel DIN rail to ensure proper grounding. The use of other DIN rail materials (for example, aluminum or plastic) that can corrode, oxidize, or are poor conductors can result in improper or intermittent grounding. Secure DIN rail to mounting surface approximately every 200 mm (7.8 in.) and use end-anchors appropriately. Be sure to ground the DIN rail properly. See Industrial Automation Wiring and Grounding Guidelines, Rockwell Automation publication [1770-4.1](#) for more information.

You can use a zinc-plated chromated steel DIN rail such as the Allen-Bradley 199-DR1; 46277-3; EN60715 - 35 x 7.5 mm (1.38 x 0.30 in.) with your FLEX 5000 I/O system.

## System Power Considerations



**ATTENTION:** Power to this equipment and all connected I/O must be supplied from a source compliant with the following: Isolated from Mains power via an approved Isolating Transformer constructed with Basic Insulation.

FLEX 5000 EtherNet/IP adapters provide power to a FLEX 5000 I/O system via a Power RTB that is connected to an external power supply and installed on the adapter.

The Power RTB provides module power to the system. Module power refers to system-side power that is used to operate the FLEX 5000 I/O system. Module power is provided through the Power RTB and passed across the module power bus.

- You must limit the SA field-side power source to **10 A, max, at 18...32V DC**.
- Confirm that the external module power supply is adequately sized for the total module power bus current draw in the system. For example, if the total module power current draw, including current inrush requirements, is 5 A, you can use a module power supply that is limited to 5 A.
- We recommend the following power supplies for each FLEX 5000 EtherNet/IP adapter:
  - **1606-XLP72E** power supply for the **5094-AENSFPR** and **5094-AENSFPRXT** adapters
  - **1606-XLE80E** power supply for the **5094-AEN2SFPR** and **5094-AEN2SFPRXT** adapters
 For more information, see Switched Mode Power Supply Specifications Technical Data, publication [1606-TD002](#).
- You must use SELV-listed power supplies for module power and SA power if there are functional safety modules that are connected to the FLEX 5000 I/O system.
- Not all power supplies are certified for use in all applications, for example, nonhazardous and hazardous environments.

**IMPORTANT** We recommend that you use separate external power supplies for the adapter and the adjacent terminal base. This practice can help prevent unintended consequences that can result if you use one supply.

For more information, see the publications that are listed in [Additional Resources on page 15](#).

## Set the Network Internet Protocol (IP) Address

FLEX 5000 EtherNet/IP adapters with SFP support ship DHCP-enabled and with their rotary switches set to 999.

If the network uses 192.168.1.x, we recommend that you use the rotary switches to set the last octet of network IP address. Valid numbers range from 001...254.

To use the rotary switches to set the IP address, turn the switches to the appropriate numbers before you install the adapter.

The bottom switch represents the first digit in the octet, the middle switch represents the second digit, and the top switch represents the third digit.

**Figure 4 - FLEX 5000 EtherNet/IP Adapter with SFP Support Rotary Switches**

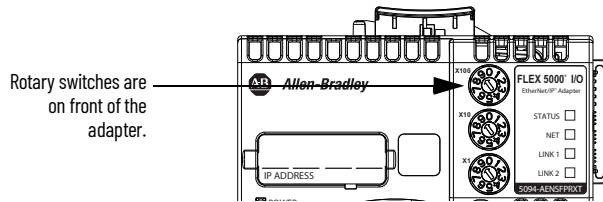

**WARNING:** When you change switch settings while power is on, an electric arc can occur. This could cause an explosion in hazardous location installations. Be sure that power is removed or the area is nonhazardous before proceeding.

At powerup, the adapter reads the rotary switches to determine if they are set to a valid number for the last octet of the IP address. If the settings are a valid number, these conditions result:

- IP address = 192.168.1.xxx (where xxx represents the switch settings)
- Subnet mask = 255.255.255.0
- Gateway address = 0.0.0.0
- The adapter does not have an assigned host name, nor does it use any Domain Name System

If the network does not use 192.168.1.x, do not change the switch positions before you install the adapter. After you install and power up the adapter, you can use the following to set the network IP address:

- DHCP server
- BOOTP DHCP EtherNet/IP Commissioning Tool – FLEX 5000 EtherNet/IP Adapters with SFP Support only use the DHCP mode
- RSLinx Classic software

To reset the adapter to its initial out-of-the-box settings, set the rotary switches to 888 and cycle power.

For more information on how to use software to set the IP address, see the EtherNet/IP Network Devices User Manual, publication [ENET-UM006](#).

## Install the Adapter onto the DIN Rail

The adapter is the first and leftmost module in a FLEX 5000 I/O system.



**ATTENTION:** During DIN rail mounting of all devices, be sure that all debris (metal chips, wire strands) is kept from falling into the adapter or modules. Debris that falls into the adapter or modules could cause damage on powerup.



**WARNING:** When you insert or remove the module while backplane power or SA power (field-side) is on, an electric arc can occur. This could cause an **explosion** in hazardous location installations. Be sure that power is removed or the area is nonhazardous before proceeding. Repeated electric arcing causes excessive wear to contacts on both the module and its mating connector. Worn contacts may create electrical resistance that can affect module operation.

1. Make sure that the DIN rail latch is in the Locked position.

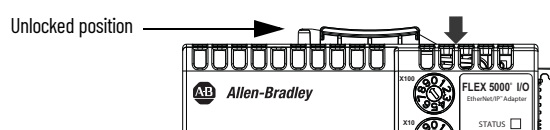
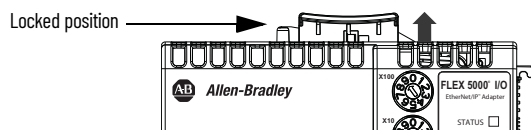



- If the DIN rail latch is in the Open position, gently press the Reset lever until the DIN rail latch pops out to the Closed position

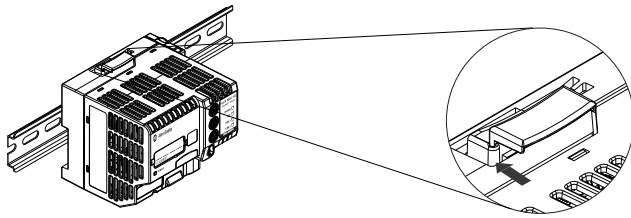

- Position the adapter so that the back of it faces the DIN rail.
- Press the adapter against the DIN rail until it clicks.
- Make sure that the adapter is latched securely.

## Install an SFP Module



**WARNING:** When you insert or remove the small form-factor pluggable (SFP) optical transceiver while power is on, an electric arc can occur. This could cause an explosion in hazardous location installations. Be sure that power is removed or the area is nonhazardous before proceeding.



**ATTENTION:** Invisible laser radiation can be emitted from disconnected fibers or connectors. Do not stare into beams or view directly with optical instruments.

You can install a 1G fiber small form-factor pluggable (SFP) module into the SFP slots of the adapter.

To install the SFP module, grasp the module on the sides and insert it into the slot until you feel the connector snap into place.

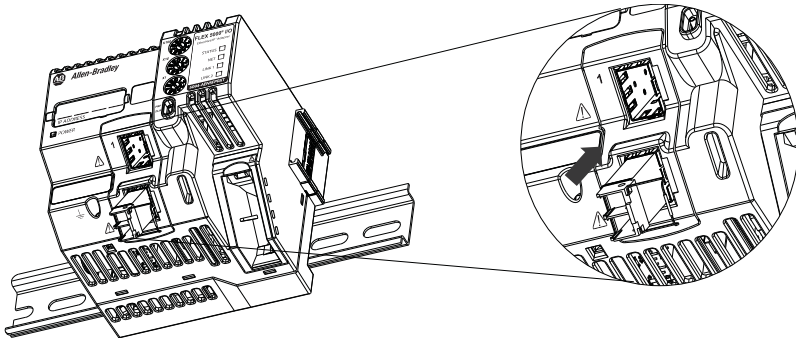

For detailed instructions on installing, removing, and connecting to SFP modules, see the documentation for the SFP module.

## Connect Power to the Adapter

Before you connect power to a FLEX 5000 EtherNet/IP with SFP Support adapter, complete the following tasks:

- Read [System Power Considerations on page 6](#).
- Confirm that the external power supply that supplies module power is adequately sized for your FLEX 5000 I/O system. For more information, see [System Power Considerations on page 6](#).
- Install the Power RTB on the adapter before you connect power to the adapter.

## Install the Power RTB



**WARNING:** If you connect or disconnect the removable terminal block (RTB) with power applied, an electric arc can occur. This could cause an explosion in hazardous location installations. The removable terminal block (RTB) does not support "removal and insertion under power" (RIUP) capability. Do not connect or disconnect the removable terminal block (RTB) while power is applied. Be sure that power is removed before proceeding.



1. If the Power RTB lever is pushed in, pull the lever until it fully extends and clicks.

**Power RTB lever pushed in**

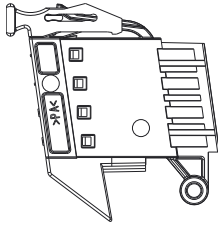

**Power RTB lever fully extended**

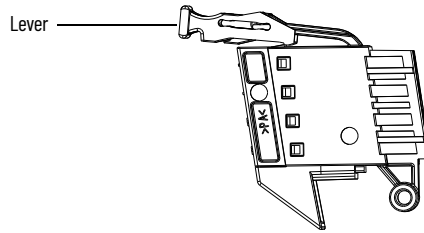

2. Insert the Power RTB into the RTB slot as shown in the graphic and press it until it clicks.

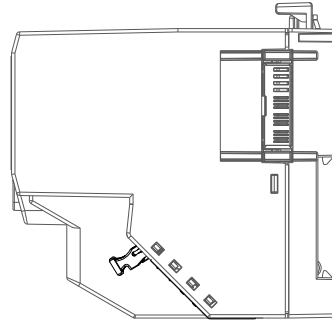
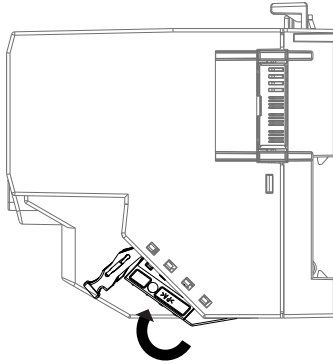

3. Press the lever until it clicks.  
The Power RTB is locked into the adapter.

### Connect Power to the Power RTB

Before you connect an external power source to the Power RTB terminals, make sure that the power source is properly sized. For example, if the total module power current draw, including current inrush requirements, is 4 A, you can use a power supply that is limited to 4 A.

**IMPORTANT** Your application can require a power control device, for example, a switch, between the external 24V DC power source and the adapter to control when the module is powered. If so, you must install the power control device at the VDC+ terminal on the removable terminal block. If you install the power control device at the VDC-terminal, the adapter can fail to power up or power down properly.

1. Verify that the external power supply is not powered.
2. Strip the insulation from the wires that you connect to the Power RTB.

TB Type	Action
Screw	0.34...2.5 mm <sup>2</sup> (22...14 AWG) = Strip 12 mm ± 1 mm (0.47 in ± 0.04 in) of insulation from the wires
Spring	0.34...1.5 mm <sup>2</sup> (22...16 AWG) = Strip 10 mm ± 1 mm (0.39 in ± 0.04 in) of insulation from the wires 2.5 mm <sup>2</sup> (14 AWG) = Strip 15 mm ± 1 mm (0.59 in ± 0.04 in) of insulation from the wires

For more information, see [Specifications on page 13](#).

3. Connect the 24V DC(-) wire from the external power supply to any - terminal.

TB Type	Action
Screw	1. Insert the wire into the terminal. 2. Turn the screwdriver to close the terminal on the wire. Torque the screw to 0.4 N•m (3.5 lb•in).
Spring	Push the wire into the terminal. If the wire is too thin, crimp a wire ferrule on the wire and insert it.

Screw-type TB

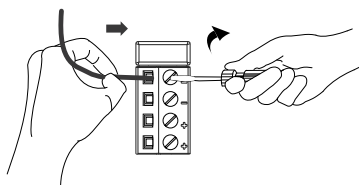

Spring-type TB

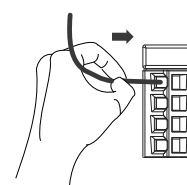

- Connect the 24V DC(+) wire from the external power supply to any + terminal.

TB Type	Action
Screw	<ol style="list-style-type: none"> <li>Insert the wire into the terminal.</li> <li>Turn the screwdriver to close the terminal on the wire. Torque the screw to 0.4 N·m (3.5 lb·in).</li> </ol>
Spring	<ol style="list-style-type: none"> <li>Push the wire into the terminal.</li> <li>If the wire is too thin, crimp a wire ferrule on the wire and insert it.</li> </ol>

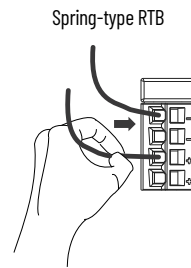
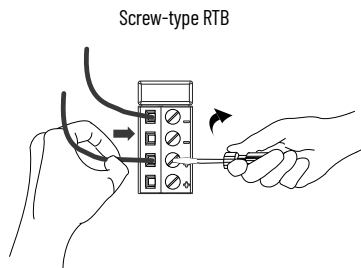

## Disconnect Wires from the Power RTB



**WARNING:** If you connect or disconnect wiring while power is applied, an electric arc can occur. This could cause an explosion in hazardous location installations. Be sure that power is removed or the area is nonhazardous before proceeding.

If necessary, complete the following tasks to disconnect wires from the Power RTB on the adapter.

TB Type	Action
Screw	<ol style="list-style-type: none"> <li>Turn the screwdriver counter-clockwise to open the terminal.</li> <li>Remove the wire.</li> </ol>
Spring	<ol style="list-style-type: none"> <li>Insert and hold a screwdriver in the right-side terminal.</li> <li>Remove the wire.</li> <li>Pull out the screwdriver.</li> </ol>

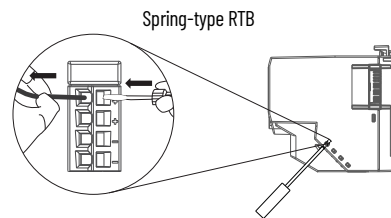
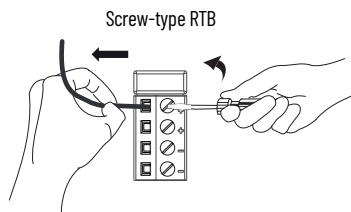

**IMPORTANT** When you insert a screwdriver to disconnect wires, follow the entry angle on the right-side terminal of a spring-type RTB.

## Connect the Adapter to an EtherNet/IP Network

If you have a fiber SFP module, insert a fiber-optic cable with an LC connector into the SFP module in the SFP slot.

If you have a copper SFP module, insert a cable with an RJ45 connector into the SFP module in the SFP slot. The recommendations for using shielded or unshielded cables are published at the Rockwell Automation technical support center in Knowledgebase article, *Grounding the Ethernet Cable Shield in an EtherNet/IP System*, #16121. The technical support center is available at: [rok.auto/knowledgebase](http://rok.auto/knowledgebase).

For more information on SFP modules, see the documentation for your SFP module.

## Install the FLEX 5000 I/O Modules

Install FLEX 5000 I/O modules on the right side of the adapter.

If the end cap is installed on the adapter, you must remove it before you can install the I/O modules.

For more information on how to install FLEX 5000 I/O modules, see the installation instructions available with each FLEX 5000 I/O module catalog number.

## Install the End Cap



**ATTENTION:** Do not discard the end cap. Use this end cap to cover the exposed interconnections on the last mounting base on the DIN rail. Failure to do so could result in equipment damage or injury from electric shock.

An end cap is shipped with a FLEX 5000 EtherNet/IP adapter.

You must install an end cap on the right side of the last terminal base in a FLEX 5000 I/O system. The end cap covers the exposed interconnections on the adapter or on the last terminal base in the system. If you do not install the end cap before powering the system, equipment damage or injury from electric shock can result.

Once you have installed all your modules for your system, install the end cap on the last terminal base.

1. Make sure that the end cap is unlocked.  
If the end cap is locked, pull the tab until it clicks.

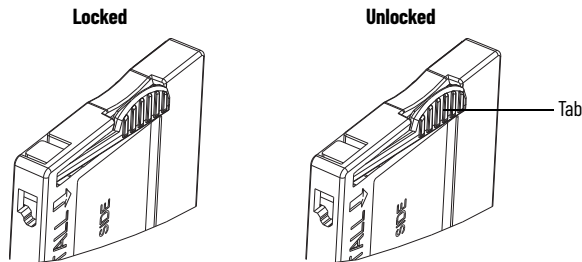

2. Align the end cap with interlocking pieces on the last terminal base in the system.

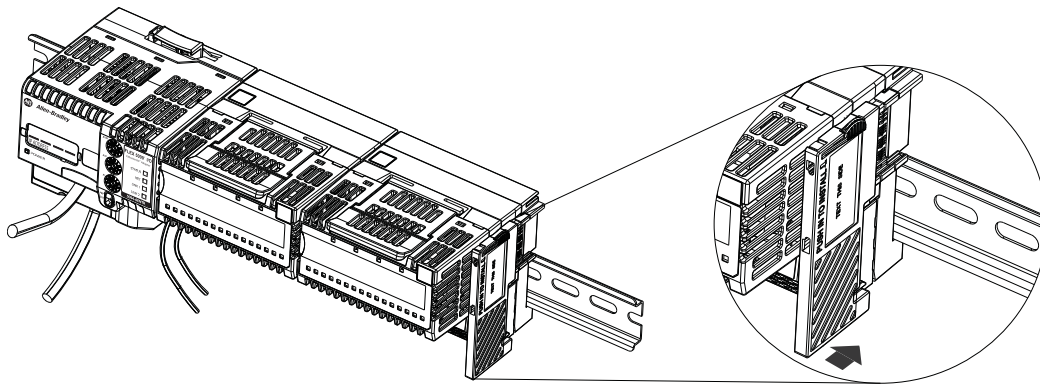

3. Push the end cap towards the DIN rail.
4. Press the locking tab until it clicks.

## Install End Anchors onto the DIN Rail

Use DIN rail end anchors (Allen-Bradley part number 1492-EAJ35 or 1492-EAHJ35) for vibration or shock environments. You must install an end anchor on both ends of your system to hold the modules firmly in position on the DIN rail.

1. Make sure that the end cap is installed on the last installed terminal base.
2. Slide an end anchor along the left-side of the DIN rail until it touches the adapter.
3. Slide an end anchor along the right-side of the DIN rail until it touches the end cap on the last installed terminal base.
4. Tighten the screw of each end anchor.

## Power the System

Once you have installed the end anchors and the modules are held firmly in position on the DIN rail, turn on power to the Power RTB.

## Remove or Replace the Adapter



**ATTENTION:** Do not remove or replace the adapter while power is applied. Interruption of the backplane can result in unintentional operation or machine motion.



**WARNING:** If you insert or remove the adapter while power is on, an electric arc can occur. This could cause an explosion in hazardous location installations. The module does not support Removal and Insertion Under Power (RIUP) capability. Do not connect or disconnect the module while power is applied. Be sure that power is removed before proceeding.

1. Turn off power to the Power RTB.

**IMPORTANT** When you remove power from a FLEX 5000 EtherNet/IP Adapter with SFP Support, you shut down power to all modules in the FLEX 5000 I/O system. That is, all system-side is removed.

2. If there are I/O modules installed, remove the I/O module from the terminal base next to the adapter. For more information on how to remove FLEX 5000 I/O modules, see the installation instructions available with each FLEX 5000 I/O module catalog number.
3. Remove all cables from the SFP modules.
4. Remove the SFP modules from the adapter.
5. Pull the lever of the Power RTB and then gently pull the Power RTB off the adapter.

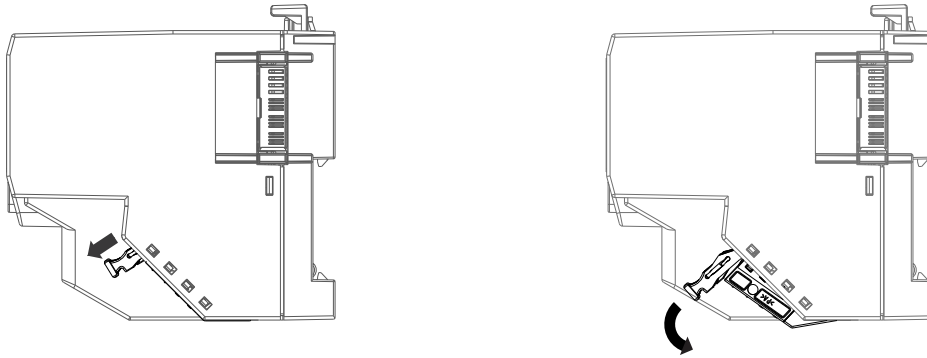

6. Press down the DIN rail latch.  
A click indicates that the DIN rail latch is unlocked.



7. Pull the adapter off the DIN rail.
8. To replace the adapter, repeat the installation steps that are described beginning at [Set the Network Internet Protocol \(IP\) Address on page 7.](#)

TB Type	Action
Screw	0.34...2.5 mm <sup>2</sup> (22...14 AWG) = Strip 12 mm ± 1 mm (0.47 in ± 0.04 in) of insulation from the wires
Spring	0.34...1.5 mm <sup>2</sup> (22...16 AWG) = Strip 10 mm ± 1 mm (0.39 in ± 0.04 in) of insulation from the wires 2.5 mm <sup>2</sup> (14 AWG) = Strip 15 mm ± 1 mm (0.59 in ± 0.04 in) of insulation from the wires

## Specifications

This table lists a subset of the module specifications. For a complete list of specifications, see the FLEX 5000 Module Specifications Technical Data, publication [5094-TD001](#).

### Specifications – FLEX 5000 EtherNet/IP Adapters with SFP Support

Attribute	5094-AENSFPR and 5094-AENSFPRXT	5094-AEN2SFPR and 5094-AEN2SFPRXT
Temperature, operating IEC 60068-2-1 (Test Ad, Operating Cold) IEC 60068-2-2 (Test Bd, Operating Dry Heat) IEC 60068-2-14 (Test Nb, Operating Thermal Shock)	-40 °C ≤ Ta ≤ +70 °C (-40 °F ≤ Ta ≤ +158 °F)	
Temperature, surrounding air, max	70 °C (158 °F)	
Temperature, nonoperating IEC 60068-2-1 (Test Ab, Unpackaged Nonoperating Cold) IEC 60068-2-2 (Test Bb, Unpackaged Nonoperating Dry Heat) IEC 60068-2-14 (Test Na, Unpackaged Nonoperating Thermal Shock)	-40...+85 °C (-40...+185 °F)	
Enclosure type rating	None (open-style)	
Relative humidity IEC 60068-2-30 (Test Db, Unpackaged Damp Heat)	5...95% noncondensing	
Vibration IEC 60068-2-6 (Test Fc, Operating)	5 g @ 10...500 Hz	
Shock, operating IEC 60068-2-27 (Test Ea, Unpackaged Shock)	30 g	
Shock, nonoperating IEC 60068-2-27 (Test Ea, Unpackaged Shock)	30 g	
Emission	IEC 61000-6-4	
ESD Immunity IEC 61000-4-2	6 kV contact discharges 8 kV air discharges	
Radiated RF Immunity IEC 61000-4-3	10V/m with 1 kHz sine-wave 80% AM from 80...6000 MHz	
EFT/B Immunity IEC 61000-4-4	±2 kV at 5 kHz on power ports	
Surge Transient Immunity IEC 61000-4-5	±1 kV line-line(DM) and ±2 kV line-earth(CM) on power ports	
Conducted RF Immunity IEC 61000-4-6	10V rms with 1 kHz sine-wave 80% AM from 150 kHz...80 MHz	
Voltage and current ratings, MP	18...32V DC, 1250 mA	18...32V DC, 1880 mA
Voltage and current ratings, MP inrush	18...32V DC, 3200 mA for 100 ms	18...32V DC, 5700 mA for 100 ms
Voltage and current ratings, backplane	15V DC, 1060 mA	15V DC, 1730 mA
Power dissipation, max	5.8 W @ 18V DC	7 W @ 18V DC
Thermal dissipation	19.8 BTU/hr @ 24V DC	23.9 BTU/hr @ 24V DC
Isolation voltage	300V (continuous), Basic Insulation Type Tested at 2121V DC for 60 s, Power to Backplane Tested at 2121V DC for 60 s, Power to Ethernet slots No isolation between communication slots	
SFP slots	3.3V, 1 W	
Wire category <sup>(1)</sup> (2)	1 - on power ports 1 - on Ethernet slots	
Wire type	Copper	
Wire size, Power RTB	0.34... 2.5 mm <sup>2</sup> (22...14 AWG) solid or stranded copper wire rated at 105 °C (221 °F), or greater, 1.2 mm (3/64 in.) insulation max, single wire connection only. Ferrule according to DIN 46 228/1.	
Wire size, functional earth terminal	2.5 mm <sup>2</sup> (14 AWG) solid or stranded copper wire rated at 105 °C (221 °F), or greater, 3.5 mm (0.14 in) max diameter including insulation, single wire connection only.	
Terminal block torque, Power RTB	Screw-type RTB: • 0.4 N•m (3.5 lb•in) Spring-type RTB: • Not applicable	
Terminal block torque, functional earth terminal	0.5 N•m (4.4 lb•in)	
Insulation-stripping length, Power RTB	Screw-type RTB connections: • 0.34...2.5 mm <sup>2</sup> (22...14 AWG) = 12 ± 1 mm (0.47 ± 0.04 in.)  Spring-type RTB connections • 0.34...1.5 mm <sup>2</sup> (22...16 AWG) = 10 ± 1 mm (0.39 ± 0.04 in.) • 2.5 mm <sup>2</sup> (14 AWG) = 15 ± 1 mm (0.59 ± 0.04 in.)	

**Specifications – FLEX 5000 EtherNet/IP Adapters with SFP Support (Continued)**

Attribute	5094-AENSFPR and 5094-AENSFPRXT	5094-AEN2SFPR and 5094-AEN2SFPRXT
Supported SFP modules <sup>(3)</sup>	1783-SFP100FX 1783-SFP100EXC 1783-SFP1GSX 1783-SFP1GLX 1783-SFP1GEXE 1783-SFP100ZXC 1783-SFP1GZX 1783-SFP1GTE	
North American temp code	T4	
UKEX/ATEX temp code	T4	
IECEx temp code	T4	
Corrosion resistance classification	<b>5094-AENSFPRXT</b> and <b>5094-AEN2SFPR XT</b> - ISA S71.04 G3	

(1) Use this Conductor Category information for planning conductor routing. See the Industrial Automation Wiring and Grounding Guidelines, publication [1770-4.1](#).

(2) Use this Conductor Category information for planning conductor routing as described in the appropriate System Level Installation Manual.

(3) You must purchase SFP modules separately. For SFP module specifications, see Stratix Ethernet Device Specifications Technical Data, publication [1783-TD002](#).

## Additional Resources

For more information on the products that are described in this publication, use these resources. You can view or download publications at [rok.auto/literature](http://rok.auto/literature).

Resource	Description
FLEX 5000 Module Specifications Technical Data, publication <a href="#">5094-TD001</a>	Provides FLEX 5000 EtherNet/IP adapters and FLEX 5000 I/O module specifications.
FLEX 5000 Removable Terminal Blocks Product Information, publication <a href="#">5094-PC001</a>	Provides wiring information for the FLEX 5000 removable terminal blocks.
Stratix Ethernet Switches Specifications Technical Data, publication <a href="#">1783-TD002</a>	Provides specifications for Stratix Ethernet devices.
FLEX 5000 Standard and Safety I/O Modules User Manual, publication <a href="#">5094-UM001</a>	Provides information on how to install, configure, and operate FLEX 5000 digital I/O modules.
FLEX 5000 Analog I/O Modules User Manual, publication <a href="#">5094-UM002</a>	Provides information on how to install, configure, and operate FLEX 5000 analog I/O modules.
FLEX 5000 High Speed Counter I/O Modules User Manual, publication <a href="#">5094-UM003</a>	Provides information on how to install, configure, and operate the FLEX 5000 I/O High-speed Counter Module.
FLEX 5000 EtherNet/IP Adapter User Manual, publication <a href="#">5094-UM005</a>	Provides information on how to install, configure, and operate the FLEX 5000 EtherNet/IP adapter.
EtherNet/IP Network Devices User Manual, publication <a href="#">ENET-UM006</a>	Describes how to install, configure, and operate EtherNet/IP adapters in Logix 5000 Control Systems.
Ethernet Reference Manual, publication <a href="#">ENET-RM002</a>	Describes how to use EtherNet/IP adapters with Logix 5000 controllers and communicate with other devices on the EtherNet/IP network.
EtherNet/IP Device Level Ring Application Technique, publication <a href="#">ENET-AP007</a>	Describes how to install, configure, and maintain linear and Device Level Ring (DLR) networks by using Allen-Bradley EtherNet/IP devices that are equipped with embedded switch technology.
EtherNet/IP Media Planning and Installation Manual This manual is available from the Open DeviceNet Vendor Association (ODVA) at <a href="http://www.odva.org/">http://www.odva.org/</a>	Describes how to use the required media components and provides information on how to plan for, install, verify, troubleshoot, and certify your EtherNet/IP network.
Industrial Automation Wiring and Grounding Guidelines, publication <a href="#">1770-4.1</a>	Provides general guidelines for installing a Rockwell Automation industrial system.
Product Certifications website, <a href="http://rok.auto/certifications">rok.auto/certifications</a>	Provides declarations of conformity, certificates, and other certification details.



# Rockwell Automation Support

Use these resources to access support information.

<b>Technical Support Center</b>	Find help with how-to videos, FAQs, chat, user forums, Knowledgebase, and product notification updates.	<a href="http://rok.auto/support">rok.auto/support</a>
<b>Local Technical Support Phone Numbers</b>	Locate the telephone number for your country.	<a href="http://rok.auto/phonesupport">rok.auto/phonesupport</a>
<b>Technical Documentation Center</b>	Quickly access and download technical specifications, installation instructions, and user manuals.	<a href="http://rok.auto/techdocs">rok.auto/techdocs</a>
<b>Literature Library</b>	Find installation instructions, manuals, brochures, and technical data publications.	<a href="http://rok.auto/literature">rok.auto/literature</a>
<b>Product Compatibility and Download Center (PCDC)</b>	Download firmware, associated files (such as AOP, EDS, and DTM), and access product release notes.	<a href="http://rok.auto/pcdc">rok.auto/pcdc</a>

## Documentation Feedback

Your comments help us serve your documentation needs better. If you have any suggestions on how to improve our content, complete the form at [rok.auto/docfeedback](http://rok.auto/docfeedback).

## Waste Electrical and Electronic Equipment (WEEE)



At the end of life, this equipment should be collected separately from any unsorted municipal waste.

Rockwell Automation maintains current product environmental compliance information on its website at [rok.auto/pec](http://rok.auto/pec).

Rockwell Otomasyon Ticaret A.Ş. Kar Plaza İş Merkezi E Blok Kat:6 34752 İçerenköy, İstanbul, Tel: +90 (216) 5698400 EEE Yönetmeliğine Uygundur

Connect with us.    

**rockwellautomation.com** — expanding **human possibility**<sup>®</sup>

AMERICAS: Rockwell Automation, 1201 South Second Street, Milwaukee, WI 53204-2496 USA, Tel: (1) 414.382.2000, Fax: (1) 414.382.4444

EUROPE/MIDDLE EAST/AFRICA: Rockwell Automation NV, Pegasus Park, De Kleetlaan 12a, 1831 Diegem, Belgium, Tel: (32) 2663 0600, Fax: (32) 2 663 0640

ASIA PACIFIC: Rockwell Automation SEA Pte Ltd., 2 Corporation Road, #04-05, Main Lobby, Corporation Place, Singapore 618494, Tel: (65) 6510-6608, Fax: (65) 6510-6699

UNITED KINGDOM: Rockwell Automation Ltd., Pitfield, Kiln Farm, Milton Keynes, MK11 3DR, United Kingdom, Tel: (44)(1908) 838-800, Fax: (44)(1908) 261-917

Allen-Bradley, expanding human possibility, FactoryTalk, FLEX 5000, Logix 5000, Rockwell Automation, RSLinx, Stratix, Studio 5000 Logix Designer, and TechConnect are trademarks of Rockwell Automation, Inc.

EtherNet/IP is a trademark of ODVA, Inc.

Trademarks not belonging to Rockwell Automation are property of their respective companies.