

Installation Instructions

Original Instructions



Allen-Bradley

by ROCKWELL AUTOMATION



Minotaur MSR138DP, MSR138.1DP Monitoring Safety Relay

Catalog Numbers 440R, MSR138DP, MSR138.1DP

Summary of Changes

This publication contains the following new or updated information. This list includes substantive updates only and is not intended to reflect all changes.

Topic	Page
Updated Response time	1
Updated Declaration of Conformity	4

Introduction

This device is intended to be part of the safety-related control system of a machine.

IMPORTANT Before installation, perform a risk assessment to determine whether the specifications of this device are suitable for all foreseeable operational and environmental characteristics of the machine to which it is to be fitted. At regular intervals during the life of the machine, check whether the characteristics foreseen remain valid.



WARNING: Danger of serious injuries. Misuse can result in malfunction.

- Only authorized and trained personnel can start up, assemble, or retrofit the device.
- Installation must be in accordance with the following steps.



WARNING: Danger of serious injuries. Incorrect installation or manipulation can result in serious injuries. Do not defeat, tamper, remove, or bypass this unit.



ATTENTION: If any malfunction or damage is present, do not attempt to repair. Replaced the unit before machine operation is allowed. Do not dismantle the unit.

Rockwell Automation does not accept responsibility for failure of this device if you do not impalement the procedures that are given in this publication, or if you use the unit outside the recommended specifications that are listed in this publication.

IMPORTANT The safety inputs of these products are described as normally closed (N.C.), that is, with the guard closed, the actuator in place (where relevant), and the machine able to start. You must prevent exposure to shock and/or vibration in excess of those specifications in IEC 60068 part: 2-6/7. Adherence to the recommended inspection and maintenance instructions forms part of the warranty.

IMPORTANT All information complies with the state of this publication and is subject to change without notice.

Description

A valid reset operation concurrently activates instantaneous and delayed safety outputs. The status indicators of instantaneous outputs CH1 and CH2 and delayed outputs CHT1 and CHT2 are lighted. At the demand of the safety function and if any fault occurs, the instantaneous safety outputs de-energize within the specified response time. The delayed safety outputs open once the delay time has lapsed. If the time-reset circuit opens during delay timing stops, the time lapse and the delayed contacts open instantaneously.

Specifications

Table 1 - Technical Specifications

Attribute	Value	
Functional safety data	According to ISO 13849-1: <ul style="list-style-type: none">• PLd, Cat. 3• MTTF_d [a]: 372• DC average: 60%	Delayed - <ul style="list-style-type: none">• PLe, Cat. 4• MTTF_d [a]: 295• DC average: 90%
	According to IEC 62061 and IEC 61508: <ul style="list-style-type: none">• SIL CL 2• PFH [1/h]: 238E-09• HFT: 1• DC: 60%	Delayed - <ul style="list-style-type: none">• SIL CL 3• PFH [1/h]: 238E-09• HFT: 1• DC: 90%
	<ul style="list-style-type: none">• TM (PTI) [a]: 20• dop [d]/hop [h] ⁽¹⁾: 365/24• tcycle [h]/[s] ⁽²⁾: 8/28,800	
Power supply	24V AC/DC, 115V AC, 230V AC 0.85...1.1 x rated voltage 50/60 Hz	
Power consumption	4 W	
Safety inputs	1 N.C., 2 N.C., light curtain	
Input simultaneity	Infinite	
Allowable input resistance, max	135 Ω	
Reset	Manual monitored or automatic/manual	
Outputs	MSR138DP: 2 N.O. safety instant, 3 N.O. safety delayed MSR138.1DP: 2 N.O. safety delayed, 1 N.C. aux. delayed, 2 N.O. safety instant.	
Output rating	<ul style="list-style-type: none">• UL: B300• 5 A/250 V AC, 24V DC• AC-15: 6 A/250 V AC• DC-13: 3 A/24 V DC	
Output rating (solid-state)	<ul style="list-style-type: none">• 30V DC• 20 mA short circuit protected	
Fuses output (external)	6 A slow blow or 10 A quick blow	
Switched current/voltage, min	10 mA/10V	
Contact material	AgSnO ₂ + 0.5μAu	
Electrical life (operations)	<ul style="list-style-type: none">• 100,000 (220V AC/4 A/880VA cosφ = 0.35)• 500,000 (220V AC/1.7 A/375VA cosφ = 0.6)• 1,000,000 (30V DC/2 A/60 W)• 2,000,000 (10V DC/0.01 A/0.1 W)	
Mechanical life	10,000,000 cycles	
Power on delay	1 s	
Response time	18 ms	
Recovery time	100 ms	
Time delays	Off delay (for delayed output contacts only)	
Impulse withstand voltage	2500V	
Pollution degree	2	

Table 1 - Technical Specifications (Continued)

Attribute	Value
Installation group	Overvoltage category III, VDE 0110-1
Operating temperature	-5...+55 °C (23...131 °F)
Relative Humidity	90%
Enclosure protection	IP40 (NEMA 1)
Terminal protection	IP20
Wiring	Use copper that withstands 60/75 °C (140/167 °F)
Conductor size	0.2...2.5 mm ² (24...12 AWG)
Torque settings	Terminal screws: 0.6...0.8 N·m (5...7 lb·in)
Case material	Polyamide PA 6.6
Mounting	35 mm (1.38 in.) DIN rail in enclosure to a minimum of IP54
Weight	24V AC/DC: 350 g (0.77 lb) 115V AC or 230V AC: 490 g (1.08 lb)
Vibration	10...55 Hz, 0.35 mm (0.01 in.)

(1) Operation time (day, hour)
(2) Cycle time (hour, sec)

Diagnostics

The solid-state status signal Y35 indicates the safety input state. The solid-state status output Y32 and the auxiliary (N.C.) output 41-42 signals the safety output state.

Safety Input

One safety device can be monitored per unit. According to the wiring inputs, cross-loop monitoring of the inputs is enabled or disabled. You can enable cross-loop monitoring for 2-channel safety inputs in 4-wire connection (S11-S12, S21-S22). Cross-loop monitoring is disabled for single-channel inputs, dual-channel inputs in 3-wire connection, and 24V DC signals. For external 24V DC signals, the negative pole must connect to S21.

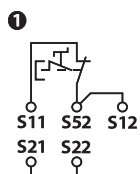

Max PLc: 1-CH ⁽¹⁾, N.C.

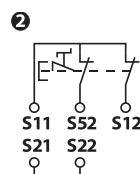

Max PLd: 2-CH ⁽²⁾, 3-wire connection

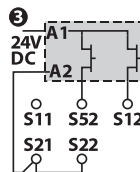

Max PLc: 2-CH ⁽²⁾, 24V DC signal

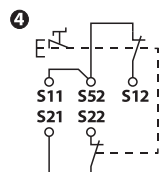

Max PLc: 2-CH ⁽²⁾, 4-wire connection, cross faults require fault reset

(1) 1-CH = Single-channel
(2) 2-CH = Dual-channel

Reset

- Reset modes - The reset mode is configurable for automatic/manual start and manual monitored reset (MSRxxxRT).
- A valid start/reset can only operate if the feedback circuit (Y1-Y2) and the time-reset circuit (Y39-Y40) are closed. Feedback contacts (N.C.) of controlled actuators connect to Y1-Y2. Start/reset during the time lapse causes a fault state. To avoid a lockout condition by start/reset, the N.C. contacts (55-56) of the MSRT138.1 safety relay connect in series with the feedback circuit Y1-Y2.
- T - Automatic/manual start ^(a)

T

In Automatic/Manual Start mode, the reset circuit S33-S34 is not monitored against signal changes (no edge detection). The safety relay is active once the safety inputs and the reset circuit close. If the safety inputs and reset circuit concurrently close during power-up, the safety relay activates immediately.

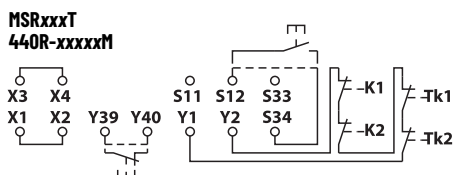
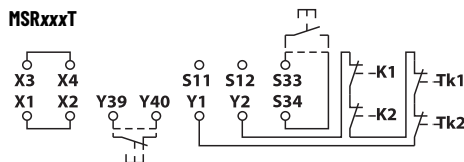

- R - Manual monitored reset ^(b)
- In Manual Monitored Reset mode, a signal change of the reset circuit (S33-S34) is required and monitored. A reset fault occurs if the safety inputs remain open while the reset circuit is closed.

R Positive edge:

The safety relay is active once the safety inputs close and then the reset circuit is closed.

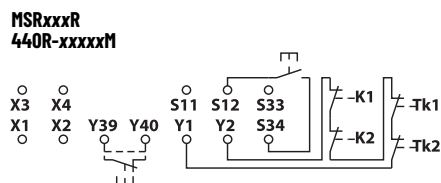
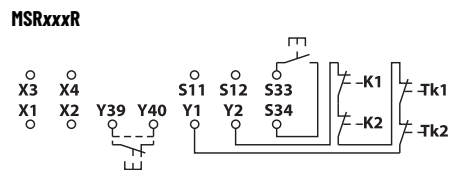

R Negative edge (440R-xxxxxM):

The safety relay is active once the safety inputs close and then the reset circuit closes and releases again. The circuit resets upon release of the Reset button.

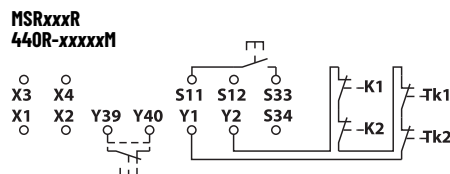

For both methods, the MSRT138/.IDP safety relay is suitable for the safety requirements according to EN/ISO 13849-1.

(a) T = Jumper X1-X2, X3-X4
(b) R = No jumper

Installation

Do not install this product until the installer obtains a copy of the instructions of the manufacturer, in a language that they can understand. This instruction publication is available in multiple languages at rok.auto/literature.

Figure 1 - Mounting

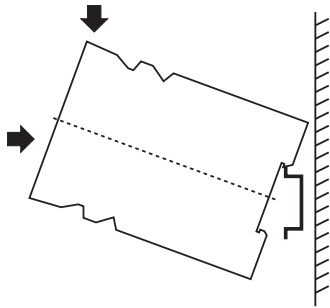

Mount the enclosure to a minimum of IP54.

Figure 2 - Removable Terminals (P versions only)

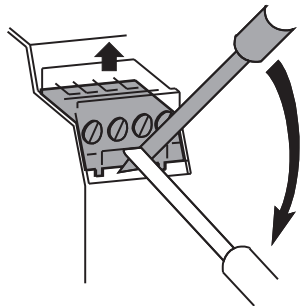

To remove the terminals, insert a screwdriver and slowly move as shown in [Figure 2](#).

Wiring Examples

Figure 3 - Example 1

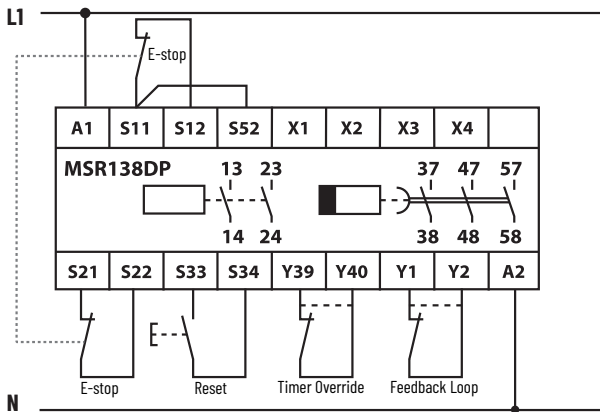

[Figure 3](#) shows dual-channel E-stop, cross fault monitored, and monitored reset.

Circuit Diagram

Figure 4 - Diagram

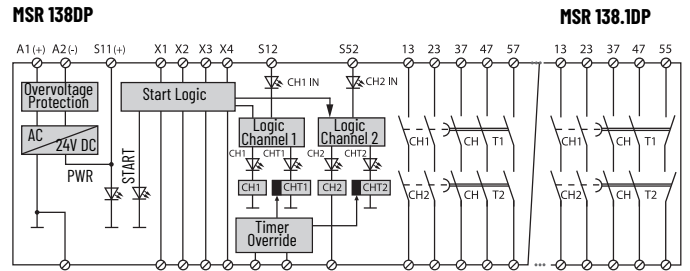

Table 2 - Circuit Diagram Explanation

Abbreviation	Description
A1, A2	Power
S11, S12, S21, S22	Safety input (N.C.)
X1, X2, X3, X4, S33, S34	Link for auto reset
Y1, Y2	Monitoring loop feedback
Y39, Y40	Timer override
13, 14	Safety output 1 (N.O.)
23, 24	Safety output 2 (N.O.)
37, 38	Timer output 1 (N.O.)
47, 48	Timer output 2 (N.O.)
57, 58 ⁽¹⁾	Timer output 3 (N.O.)
55, 56 ⁽²⁾	Timer output 3 (N.C.)
PWR	Status indicator illuminates green when the unit is powered, flashing green if cross-loop faults occur
CH1	Status indicator illuminates green when the safety output channel 1 activates
CH2	Status indicator illuminates green when the safety output channel 2 activates
CH1 IN	Status indicator illuminates green when the safety input channel 1 closes
CH2 IN	Status indicator illuminates green when the safety input channel 2 closes
CHT1	Status indicator illuminates green when Delayed Safety Output channel 1 activates
CHT2	Status indicator illuminates green when Delayed Safety Output channel 2 activates
Start	Status indicator illuminates green when the reset circuit closes

(1) MSR 138DP
(2) MSR 138.IDP

Approximate Dimensions

Figure 5 - Dimensions [mm (in.)]

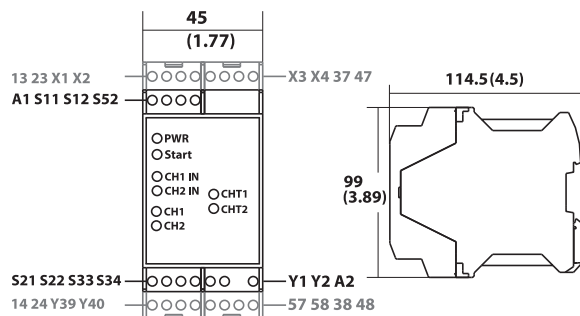

Safety Specifications

You can use the MSR138/.1DP safety relay in safety circuits according to DIN EN 60204-1/VDE 0113 part 1. Safety requirements that are specified in [Specifications on page 1](#) are maximum, based on the operation mode and wiring.

Specifications are applicable only if the safety function is demanded at least once within 6 months. All diagnostic tests are conducted at least before next demand. The mission time (TM) for the proof test interval (PTI) is adopted. Components failure rates according to SN29500.

Figure 6 - Safety Circuit

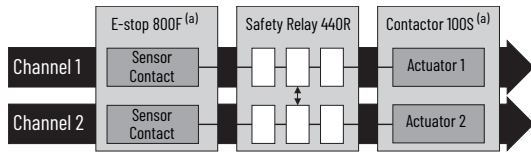

(a) Example

Declaration of Conformity

CE Conformity

Rockwell Automation declares that the products that are shown in this document conform with the Essential Health and Safety Requirements (EHSRs) of the European Machinery Directive (2006/42/EC) and EMC Directive 2014/30/EU.

For a comprehensive CE certificate visit: rok.auto/certifications.

UKCA Conformity

Rockwell Automation declares that the products that are shown in this document are in compliance with the Supply of Machinery (Safety) Regulations (2008 No. 1597) and Electromagnetic Compatibility Regulations (2016 No. 1091).

For a comprehensive UKCA certificate visit: rok.auto/certifications.

Waste Electrical and Electronic Equipment (WEEE)







At the end of life, this equipment should be collected separately from any unsorted municipal waste.

Rockwell Automation maintains current product environmental compliance information on its website at rok.auto/pec.

Your comments help us serve your documentation needs better. If you have any suggestions on how to improve our content, complete the form at rok.auto/docfeedback.

For technical support, visit rok.auto/support.

Rockwell Otomasyon Ticaret A.Ş. Kar Plaza İş Merkezi E Blok Kat:6 34752, İçerenköy, İstanbul, Tel: +90 (216) 5698400 EEE Yönetmeliğine Uygundur

Connect with us.    

rockwellautomation.com

expanding **human possibility**[®]

AMERICAS: Rockwell Automation, 1201 South Second Street, Milwaukee, WI 53204-2496 USA, Tel: (1) 414.382.2000, Fax: (1) 414.382.4444

EUROPE/MIDDLE EAST/AFRICA: Rockwell Automation NV, Pegasus Park, De Kleetlaan 12a, 1831 Diegem, Belgium, Tel: (32) 2 663 0600, Fax: (32) 2 663 0640

ASIA PACIFIC: Rockwell Automation, Level 14, Core F, Cyberport 3, 100 Cyberport Road, Hong Kong, Tel: (852) 2887 4788, Fax: (852) 2508 1846

UNITED KINGDOM: Rockwell Automation Ltd. Pitfield, Kiln Farm Milton Keynes, MK11 3DR, United Kingdom, Tel: (44)(1908) 838-800, Fax: (44)(1908) 261-917

Allen-Bradley, expanding human possibility, Guardmaster, Minotaur, and Rockwell Automation are trademarks of Rockwell Automation, Inc.

Trademarks not belonging to Rockwell Automation are property of their respective companies.

Publication 440R-IN088A-EN-P - July 2022 | Supersedes Publication 440R-IN063A-MU-P - April 2011

Copyright © 2022 Rockwell Automation, Inc. All rights reserved. Printed in the U.S.A.

95302170
10000176981 Ver 01