

Installation Instructions

Original Instructions



Allen-Bradley

by ROCKWELL AUTOMATION



42CE RightSight C18 Photoelectric Sensors

Catalog Numbers 42CE-D2MNA1-A2, 42CE-D2MNA1-D4, 42CE-D2MPA1-A2, 42CE-D2MPA1-D4, 42CE-B2MNB1-A2, 42CE-B2MNB1-D4, 42CE-B2MPB1-A2, 42CE-B2MPB1-D4, 42CE-B2MNB2-A2, 42CE-B2MNB2-D4, 42CE-B2MPB2-A2, 42CE-B2MPB2-D4, 42CE-B2MNA3-A2, 42CE-B2MNA3-D4, 42CE-B2MPA3-A2, 42CE-B2MPA3-D4, 42CE-N2MNA1-A2, 42CE-N2MNA1-D4, 42CE-N2MPA1-A2, 42CE-N2MPA1-D4, 42CE-P2MNB1-A2, 42CE-P2MNB1-D4, 42CE-P2MPB1-A2, 42CE-P2MPB1-D4, 42CE-P2MNA1-A2, 42CE-P2MNA1-D4, 42CE-P2MPA1-A2, 42CE-P2MPA1-D4, 42CE-E2EZB1-A2, 42CE-E2EZB1-D4, 42CE-R2MNB1-A2, 42CE-R2MNB1-D4, 42CE-R2MPB1-A2, 42CE-R2MPB1-D4

Summary of Changes

This publication contains the following new or updated information. This list includes substantive updates only and is not intended to reflect all changes.

Topic	Page
Updated Overview	1
Updated Status Indicators and User Interface image callout	1
Updated Figure 1 and Figure 2	2
Updated Figure 20 and Figure 21	6
Updated Table 3	6

Overview

The Allen-Bradley® RightSight™ C18 family offers a wide range of sensing modes and an adjustment knob that simplifies sensitivity adjustment for maximum application flexibility.

The RightSight sensor offers an industry standard 18 mm (0.71 in.) cylindrical housing ideal for compact housing installations.

Features

- Visible light source offered on select models for ease of alignment
- Embedded IO-Link 1.1 communication protocol with enhanced IO-Link parameters
- Input to disable light source on transmitted beam emitter
- IP67 rated enclosure
- -40...+65 °C (-40...+149 °F) operating temperatures

Status Indicators and User Interface

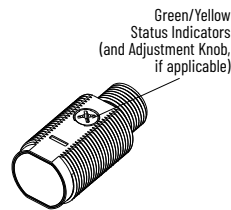

The following tables provide indicator status in the Run mode during operation. The sensor is always in Run mode except when being taught.

Table 1 - Standard I/O Operating Mode Indication

Color	Status	Description
Green	OFF	Power is OFF
	ON	Power is ON
	Flashing (6 Hz)	Unstable light: 0.8 X < margin < 1.5 X
	Flashing (1.4 Hz)	Output short circuit protection active
Orange	OFF	Output de-energized
	ON	Output energized

Table 2 - IO-Link Operation Mode Indication

Color	Status	Description
Green	OFF	Power is OFF
	Flashing (1 Hz)	Power is ON
Orange	OFF	Output de-energized
	ON	Output energized

Sensor User Interface

The green status indicator can also serve as a setup alignment aid that indicates that a margin of 1.5 has been reached. The sensor receives at least 1.5 times the signal strength back from the target that is required to trigger an output signal. In general, it is desirable to have a higher margin to help overcome any deteriorating environmental conditions, that is, dust build-up on the sensor lens. When aligning the sensor, the optimum performance can be obtained if this margin indicator is illuminated with the target in place. When aligning diffuse mode sensors, verify that the sensitivity is set at its maximum setting; use the single-turn adjustment knob. Pan the sensor left, right, up, and down to center the beam on the target. Decrease this setting to help prevent the sensor from detecting a background object. If this problem persists, the application requires the use of a background suppression, background reflection, or retroreflective sensing mode.

Sensor Alignment

1. Verify that the sensitivity knob is set at its maximum (factory default) setting.
2. Pan the sensor to the left, right, up, and down to center the beam on the sensed object (for diffuse), reflector (for retroreflective), or transmitter (for transmitted beam). Affix the sensor position when the green status indicator is ON (not flashing) and the yellow output indicator is ON (light sensed and L.O. output energized).

This configuration helps achieve a good margin and that the signal received is greater than twice the signal that is required to energize the L.O. output.

3. Depending on your application, do the following:
 - a. For diffuse applications, remove the object being sensed and observe the green status indicator. If the green indicator is flashing (at 6 Hz), the sensor is receiving more than half the signal required to energize the L.O. output when there can be minimal or no received signal. It indicates that the sensor is getting close to detection of the background. Stability can be optimized by reducing the reflectivity of the background or reducing the sensitivity. Reduce the sensitivity to shorten the sensing range. If sensitivity is reduced, check that both the green and yellow indicators are on when the object is detected ([step 2](#)). In applications where the full range is needed, for example, sensitivity cannot be reduced, the green indicator can be left flashing.
 - b. For retroreflective and transmitted beam applications, place the object to be sensed in the beam path and observe the green indicator. If the green indicator is flashing (at 6 Hz), that sensor is receiving more than half the signal required to energize the L.O. output when there can be minimal, or no signal received. It indicates that the object being detected is letting some light go through (semi-transparent or too small). Adjust sensitivity and repeat [step 2](#).

Sensor Configuration

The 42CE RightSight C18 can be configured with the adjustment knob or via IO-Link.

Background Suppression Models (42CE-B2xxA3-xx)

Once securely installed, the sensing range of the sensor must be set using the adjustment knob. This knob is used to set the cutoff point (the point at which the background is suppressed) of the sensor.

To teach the sensor:

1. Apply power to the sensor and verify that the green power/stability is ON.
2. With a screwdriver, adjust the sensor background cutoff point to its minimum setting by turning the knob counterclockwise until you reach the stop.
3. Present the target at the desired distance.
4. Set the background cutoff point by rotating the knob clockwise until the orange status indicator turns ON, which indicates that the target has been sensed and the sensor has suppressed the background. If the indicator does not turn ON, it means that the target is beyond the background cutoff point and is ignored.

The sensor is now configured to detect targets between 30 mm (1.18 in.) and this cutoff point. The reflectivity of the target influences the distance between the target and the cutoff point. As illustrated in the image below, a nonreflective target requires a greater gap due to the smaller amount of light being returned to the sensor.

Figure 1 - Background Suppression Application Example

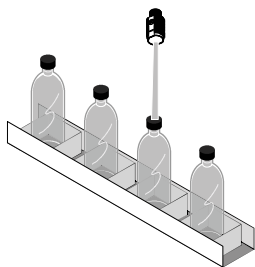

Background Reflection Models (42CE-N2xxA1-xx)

Once securely installed, the sensing range of the sensor must be set using the adjustment knob. This knob is used to set the cutoff point (the point at which the background is suppressed) of the sensor.

To teach the sensor:

1. Apply power to the sensor and verify that the green power/stability is ON.
2. With a screwdriver, adjust the sensor background cutoff point to its minimum setting by turning the knob counterclockwise until you reach the stop.
3. Present the background to the sensor.
4. Set the background reflection cutoff point by rotating the knob clockwise until the orange status indicator turns ON.
5. Rotate the adjustment knob counterclockwise until the orange status indicator turns OFF. The background reflection cutoff point is now set. When an object is placed between the sensor lens and this point, it is detected due to the absence of reflected light.

As with the background suppression sensing mode, the reflectivity of the target influences the gap between the background and the cutoff point.

Figure 2 - Background Reflection Application Example

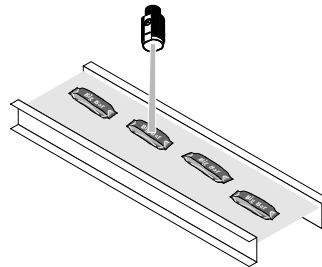

Wiring Diagrams

The quick-disconnect connector is shown in the following diagrams. The pin numbers correspond to plug connectors on the sensor.

Figure 3 - Micro (M12) Plug QD on Pigtail and Integral Pico (M8) Plug QD Pinout

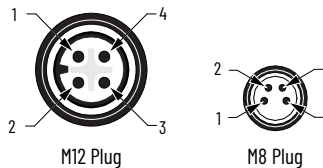

Output Wiring

Figure 4 - PNP Complementary Models

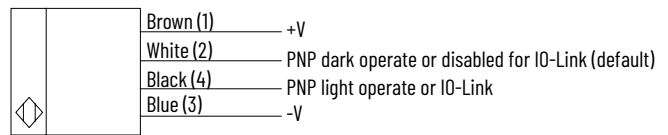
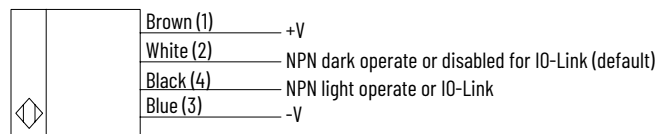
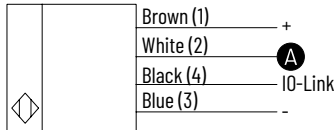

Figure 5 - NPN Complementary Models



Transmitted Beam Emitter



Item	Description
A	For normal operation, the black wire (Pin 4) needs no connection. To deactivate the light source, connect the black wire (Pin 4) to +V.

The IO-Link output Pin 4 (black) does not support the connection of multiple sensors in series (for example, one sensor powers the next sensor). The connection of multiple sensors in series can be achieved when using Pin 2 (white) outputs or by ordering a non-IO-Link catalog number.

Visit rok.auto/knowledgebase or contact your local Allen-Bradley distributor or Rockwell Automation sales office for specific ordering information.

Specifications

Attribute	Value
Certifications	CE Marked for all applicable directives, cULus Listed, KCC, RCM, UKCA Marked for all applicable regulations
EMC Directive	EN 60947-5-2
Standards	UL 60947-5-2
Ambient light immunity	EN 60697-5-2:2007+A:2012

For declarations of conformity and certification details, visit rok.auto/certifications.

Functional Safety Parameters	
MTTFd	860 a
User Interface	
Status indicators	Green and orange
Adjustments	Adjustment knob depending on catalog number
Optical	
Light-emitting diode (LED)	Visible red on all models
Electrical	
Operating voltage	10 ...30V DC
Current consumption	Less than 35 mA
Sensor protection	Reverse polarity and short circuit
Output	
Output types	2 x push pull outputs (PNP and NPN), Light Operate and Dark Operate
Response Time	
Diffuse, max	0.5 ms
Transmitted beam, max	0.5 ms
Polarized retroreflective, max	0.5 ms
Clear object detection, max	0.5 ms
Background suppression, max	0.66 ms
Background reflection, max	0.66 ms
Load Current	
Resistive load, max	100 mA
Mechanical	
Housing material	ABS
Lens material	Acrylic
Environmental	
Enclosure rating	IP67
Operating temperature	-40...+65 °C (-40...+149 °F)

Typical Response Curves

Diffuse

Figure 6 - 800 mm (31.5 in.) Sensing Distance - Margin Curves

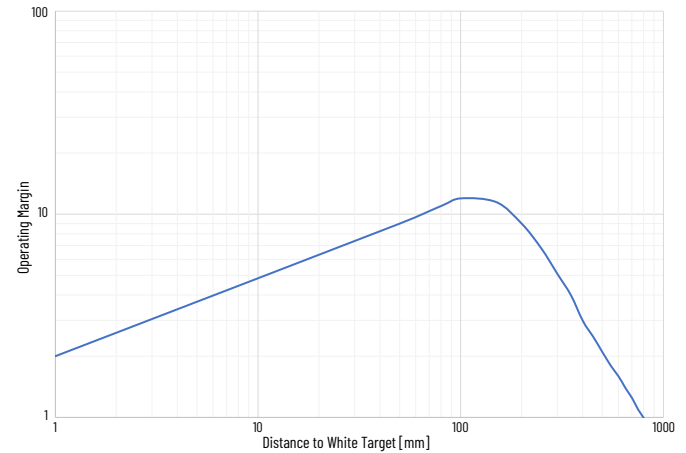
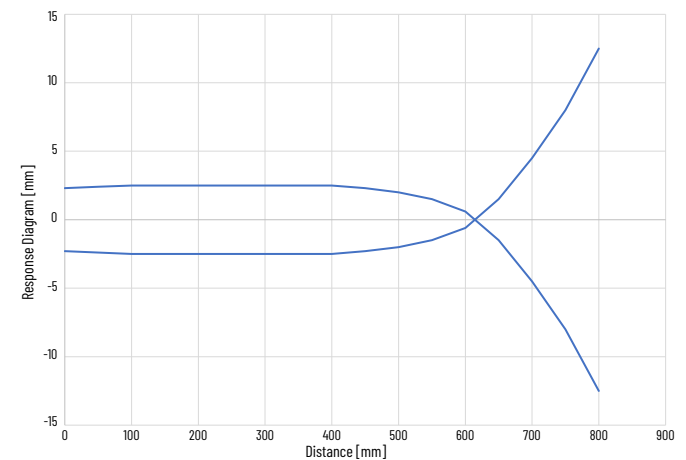

Figure 7 - 800 mm (31.5 in.) Sensing Distance - Beam Pattern



Polarized Retroreflective

Figure 8 - 6 m (19.7 ft) Sensing Range - Margin Curve

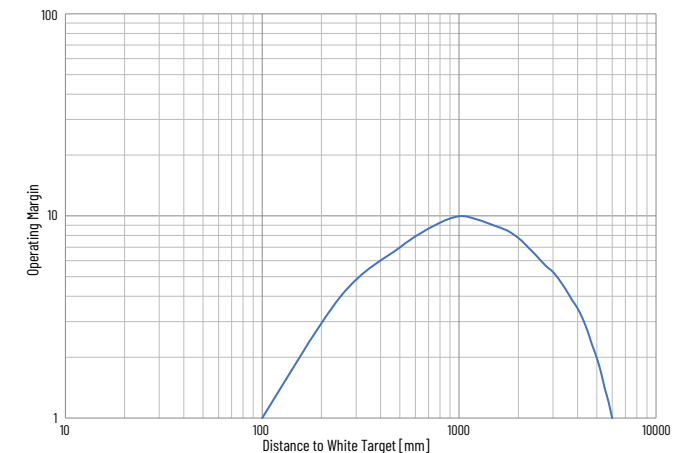

Figure 9 - 6 m (19.7 ft) Sensing Range - Beam Pattern

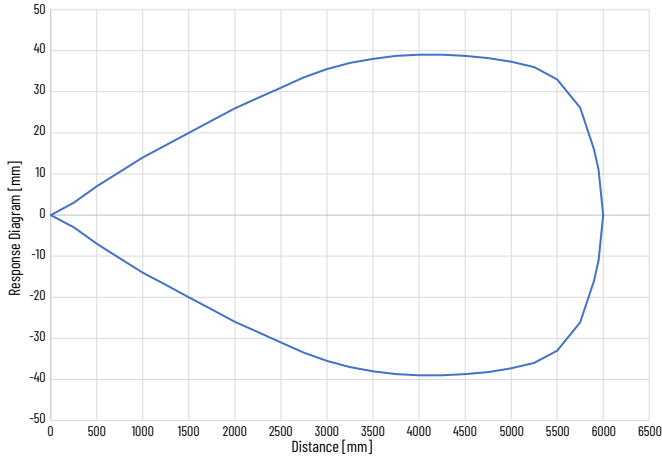
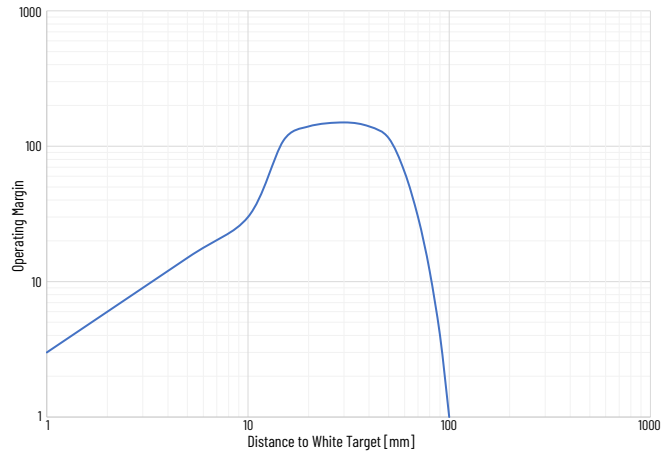

Figure 12 - 100 mm (3.94 in.) Sensing Range - Margin Curves



Background Suppression

Figure 10 - 50 mm (1.97 in.) Sensing Range - Margin Curves

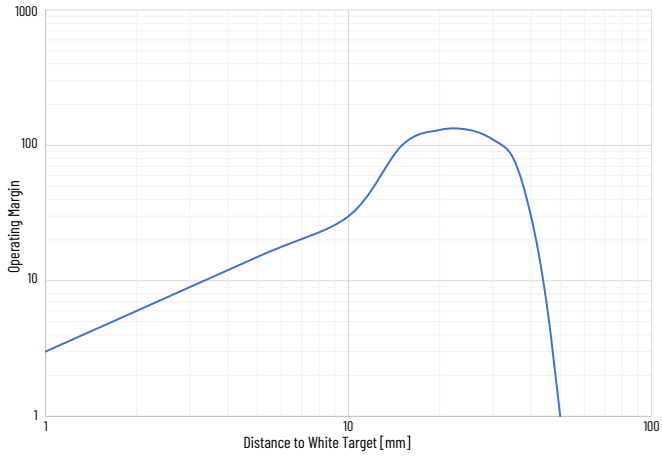

Figure 13 - 100 mm (3.94 in.) Sensing Range - Beam Pattern

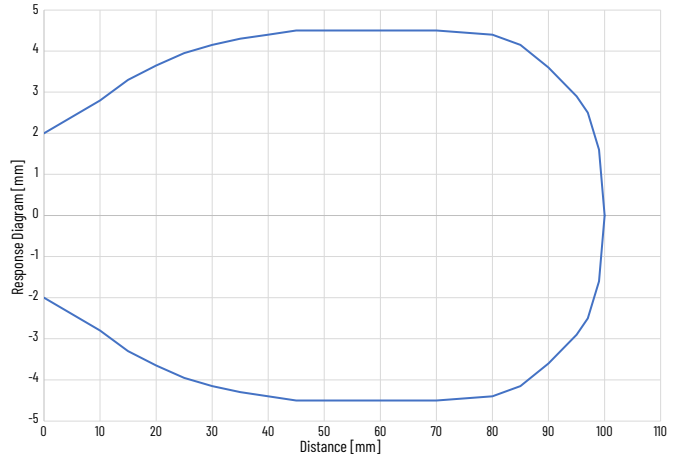

Figure 11 - 50 mm (1.97 in.) Sensing Range - Beam Pattern

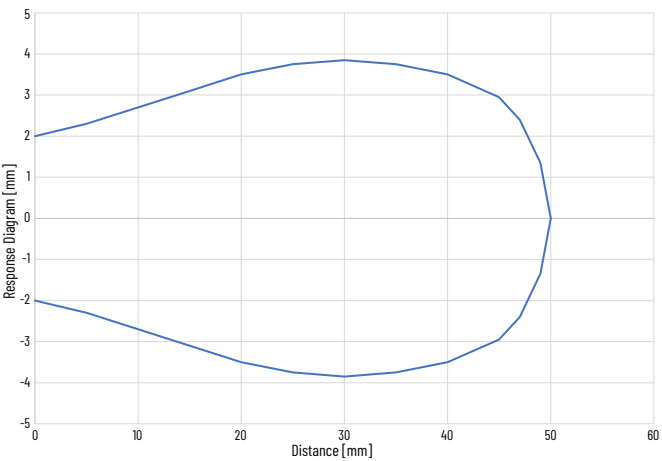

Figure 14 - 210 mm (8.27 in.) Sensing Range - Margin Curves

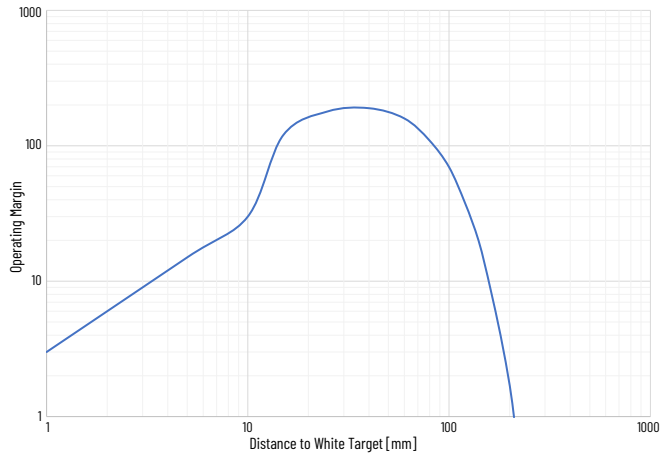
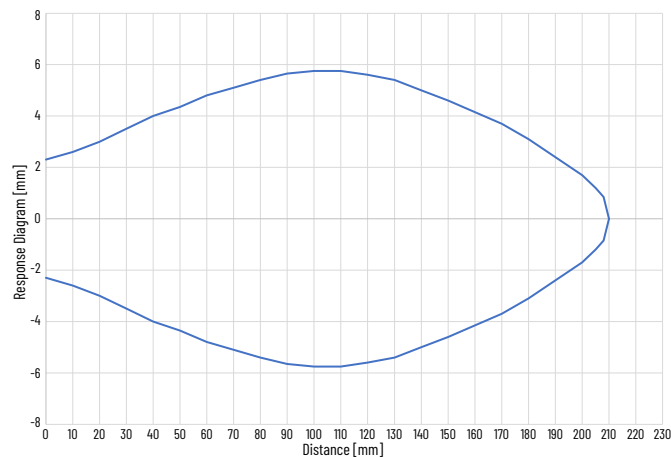

Figure 15 - 210 mm (8.27 in.) Sensing Range - Beam Pattern



Background Reflection

Figure 16 - 210 mm (8.27 in.) Sensing Range - Margin Curves

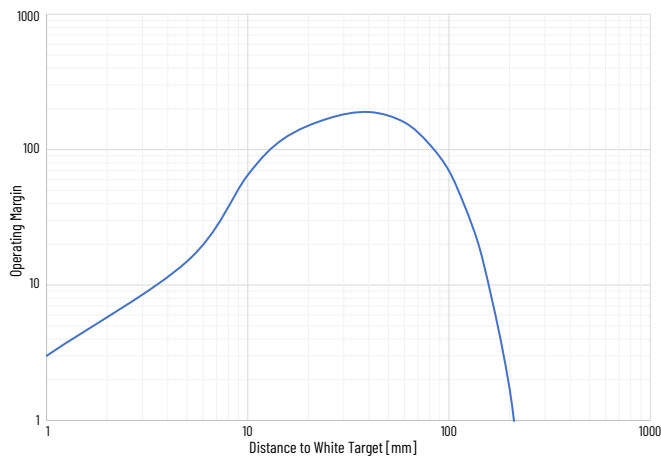
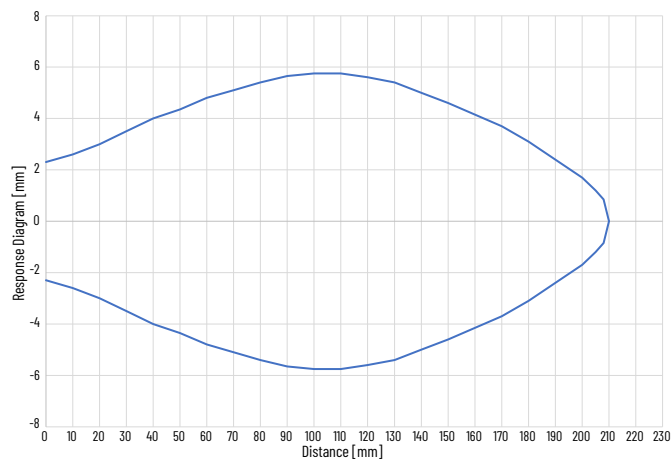

Figure 17 - 210 mm (8.27 in.) Sensing Range - Beam Patterns



Transmitted Beam

Figure 18 - 25 m (82 ft) Sensing Range - Margin Curves

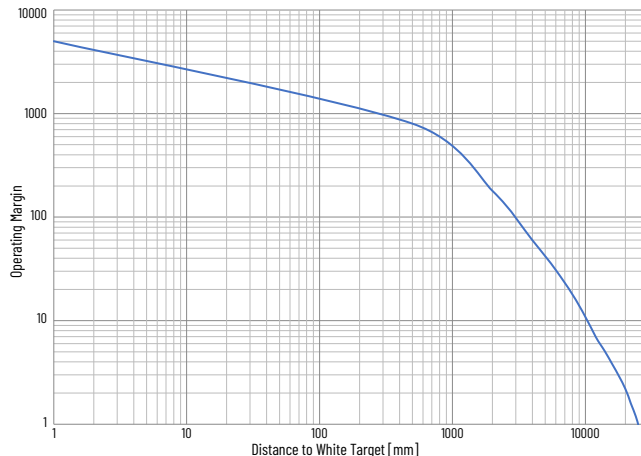
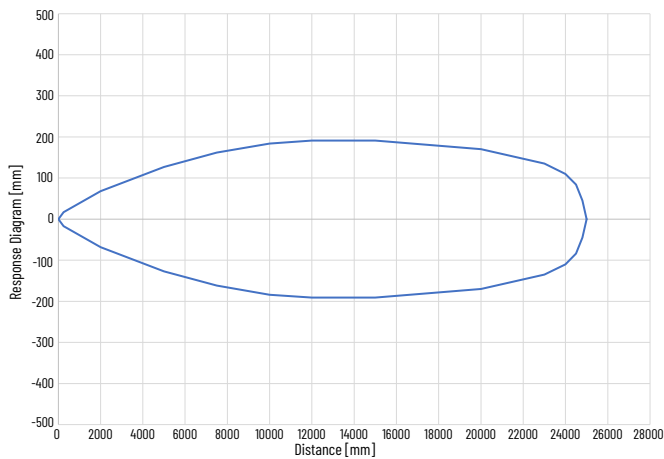

Figure 19 - 25 m (82 ft) Sensing Range - Beam Pattern



Approximate Dimensions

Dimensions shown in mm (in.).

Figure 20 - 2 m (6.6 ft) Cable Models

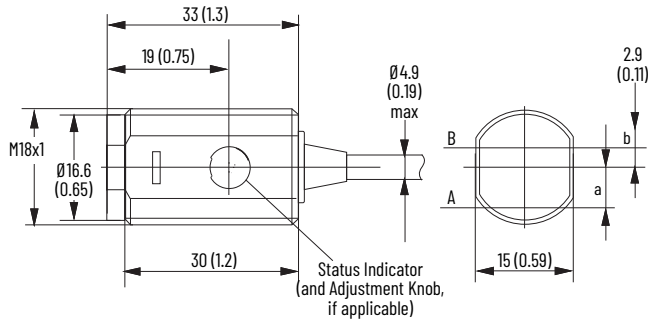

Figure 21 - Integral M8 Pico QD Models

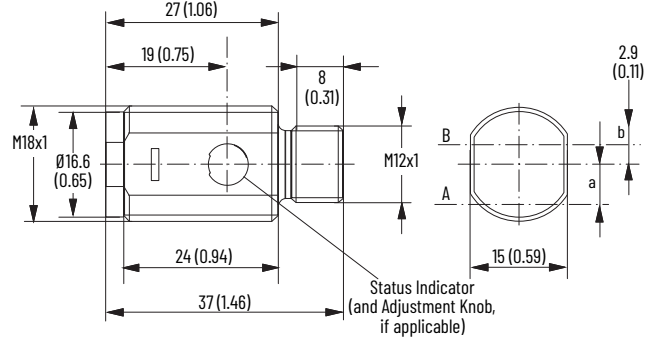

Table 3 - Emitter and Receiver Axis Position

Sensing Mode	A [mm (in.)]	B [mm (in.)]
Diffuse	3.5 (0.14)	3.5 (0.14)
Background suppression	4.5 (0.18)	2.9 (0.11)
Background reflection	3.5 (0.14)	3.5 (0.14)
Polarized retroreflective	3.5 (0.14)	3.5 (0.14)
Transmitted beam emitter	0 (0)	
Transmitted beam receiver	0 (0)	

Waste Electrical and Electronic Equipment (WEEE)







At the end of life, this equipment should be collected separately from any unsorted municipal waste.

Rockwell Automation maintains current product environmental compliance information on its website at rok.auto/pec.

Your comments help us serve your documentation needs better. If you have any suggestions on how to improve our content, complete the form at rok.auto/docfeedback.

For technical support, visit rok.auto/support.

Rockwell Otomasyon Ticaret A.Ş. Kar Plaza İş Merkezi E Blok Kat:6 34752 İçerenköy, İstanbul, Tel: +90 (216) 5698400 EEE Yönetmeliğine Uygundur

Connect with us.    

rockwellautomation.com

expanding human possibility®

AMERICAS: Rockwell Automation, 1201 South Second Street, Milwaukee, WI 53204-2496 USA, Tel: (1) 414.382.2000

EUROPE/MIDDLE EAST/AFRICA: Rockwell Automation NV, Pegasus Park, De Kleetlaan 12a, 1831 Diegem, Belgium, Tel: (32) 2663 0600

ASIA PACIFIC: Rockwell Automation SEA Pte Ltd, 2 Corporation Road, #04-05, Main Lobby, Corporation Place, Singapore 618494, Tel: (65) 6510 6608

UNITED KINGDOM: Rockwell Automation Ltd., Pitfield, Kiln Farm, Milton Keynes, MK11 3DR, United Kingdom, Tel: (44)(1908) 838-800

Allen-Bradley, expanding human possibility, RightSight, and Rockwell Automation are trademarks of Rockwell Automation, Inc. Trademarks not belonging to Rockwell Automation are property of their respective companies.

Publication 42CE-IN001B-EN-P - January 2025 | Supersedes Publication 42CE-IN001A-EN-P - December 2024

Copyright © 2025 Rockwell Automation, Inc. All rights reserved. Printed in the U.S.A.

10007925847 Ver 01