

# Micro810 12 Point Programmable Controllers

Catalog Numbers 2080-LC10-12AWA, 2080-LC10-12QWB, 2080-LC10-12QBB, 2080-LC10-12DWD

<http://rockwellautomation.com/literature>

<p><b>FR</b> Cette publication est disponible en français sous forme électronique (fichier PDF). Pour la télécharger, rendez-vous sur la page Internet indiquée ci-dessus.</p>	<p><b>PT</b> Esta publicação está disponível em português como PDF. Vá ao endereço web que aparece acima para encontrar e fazer download da publicação.</p>
<p><b>IT</b> Questa pubblicazione è disponibile in Italiano in formato PDF. Per scaricarla collegarsi al sito Web indicato sopra.</p>	<p><b>ZH</b> 本出版物備有中文PDF格式文件，可從上面的網址找到並下載本出版物。</p>
<p><b>DE</b> Diese Publikation ist als PDF auf Deutsch verfügbar. Gehen Sie auf die oben genannte Web-Adresse, um nach der Publikation zu suchen und sie herunterzuladen.</p>	<p><b>ZC</b> 本出版物備有中文PDF檔，可由上列網址下載。</p>
<p><b>ES</b> Esta publicación está disponible en español como PDF. Diríjase a la dirección web indicada arriba para buscar y descarga esta publicación.</p>	<p><b>KO</b> 본 간행물은 한글판 PDF 파일로 준비되어 있습니다. 위에 있는 웹사이트에 가서서 간행물을 다운로드 하십시오.</p>

## Table of Contents

Topic	Page
Important User Information	2
Additional Resources	6
Overview	7
Controller Overview	7
Mount the Module	8
Wire the Controller	11
Specifications	12

## Important User Information

Solid state equipment has operational characteristics differing from those of electromechanical equipment. Safety Guidelines for the Application, Installation and Maintenance of Solid State Controls (Publication [SGI-1.1](#) available from your local Rockwell Automation sales office or online at <http://rockwellautomation.com/literature>) describes some important differences between solid state equipment and hard-wired electromechanical devices. Because of this difference, and also because of the wide variety of uses for solid state equipment, all persons responsible for applying this equipment must satisfy themselves that each intended application of this equipment is acceptable.





In no event will Rockwell Automation, Inc. be responsible or liable for indirect or consequential damages resulting from the use or application of this equipment.

The examples and diagrams in this manual are included solely for illustrative purposes. Because of the many variables and requirements associated with any particular installation, Rockwell Automation, Inc. cannot assume responsibility or liability for actual use based on the examples and diagrams.

No patent liability is assumed by Rockwell Automation, Inc. with respect to use of information, circuits, equipment, or software described in this manual.

Reproduction of the contents of this manual, in whole or in part, without written permission of Rockwell Automation, Inc., is prohibited.

Throughout this manual, when necessary, we use notes to make you aware of safety considerations.

	<b>WARNING:</b> Identifies information about practices or circumstances that can cause an explosion in a hazardous environment, which may lead to personal injury or death, property damage, or economic loss.
	<b>ATTENTION:</b> Identifies information about practices or circumstances that can lead to personal injury or death, property damage, or economic loss. Attentions help you identify a hazard, avoid a hazard and recognize the consequences.
	<b>SHOCK HAZARD:</b> Labels may be on or inside the equipment (for example, drive or motor) to alert people that dangerous voltage may be present.
	<b>BURN HAZARD:</b> Labels may be on or inside the equipment (for example, drive or motor) to alert people that surfaces may reach dangerous temperatures.
<b>IMPORTANT</b>	<b>IMPORTANT:</b> Identifies information that is critical for successful application and understanding of the product.

---

## Environment and Enclosure

---



**ATTENTION:** This equipment is intended for use in a Pollution Degree 2 industrial environment, in overvoltage Category II applications (as defined in IEC 60664-1), at altitudes up to 2000 m (6562 ft) without derating.

This equipment is considered Group 1, Class A industrial equipment according to IEC/CISPR 11. Without appropriate precautions, there may be difficulties with electromagnetic compatibility in residential and other environments due to conducted and radiated disturbances.

This equipment is supplied as open-type equipment. It must be mounted within an enclosure that is suitably designed for those specific environmental conditions that will be present and appropriately designed to prevent personal injury resulting from accessibility to live parts. The enclosure must have suitable flame-retardant properties to prevent or minimize the spread of flame, complying with a flame spread rating of 5VA, V2, V1, V0 (or equivalent) if non-metallic. The interior of the enclosure must be accessible only by the use of a tool. Subsequent sections of this publication may contain additional information regarding specific enclosure type ratings that are required to comply with certain product safety certifications.

In addition to this publication, see:

- Industrial Automation Wiring and Grounding Guidelines, Rockwell Automation publication [1770-4.1](#), for additional installation requirements.
- NEMA Standard 250 and IEC 60529, as applicable, for explanations of the degrees of protection provided by different types of enclosure.

---

## Preventing Electrostatic Discharge

---





**ATTENTION:** This equipment is sensitive to electrostatic discharge, which can cause internal damage and affect normal operation. Follow these guidelines when you handle this equipment:

- Touch a grounded object to discharge potential static.
  - Wear an approved grounding wriststrap.
  - Do not touch connectors or pins on component boards.
  - Do not touch circuit components inside the equipment.
  - Use a static-safe workstation, if available.
  - Store the equipment in appropriate static-safe packaging when not in use.
-

## North American Hazardous Location Approval

The following modules are North American Hazardous Location approved:  
 2080-LC10-12AWA, 2080-LC10-12QWB, 2080-LC10-12QBB, 2080-LC10-12DWD

<b>The following information applies when operating this equipment in hazardous locations:</b>	<b>Informations sur l'utilisation de cet équipement en environnements dangereux:</b>
<p>Products marked "CL I, DIV 2, GP A, B, C, D" are suitable for use in Class I Division 2 Groups A, B, C, D, Hazardous Locations and nonhazardous locations only. Each product is supplied with markings on the rating nameplate indicating the hazardous location temperature code. When combining products within a system, the most adverse temperature code (lowest "T" number) may be used to help determine the overall temperature code of the system. Combinations of equipment in your system are subject to investigation by the local Authority Having Jurisdiction at the time of installation.</p>	<p>Les produits marqués "CL I, DIV 2, GP A, B, C, D" ne conviennent qu'à une utilisation en environnements de Classe I Division 2 Groupes A, B, C, D dangereux et non dangereux. Chaque produit est livré avec des marquages sur sa plaque d'identification qui indiquent le code de température pour les environnements dangereux. Lorsque plusieurs produits sont combinés dans un système, le code de température le plus défavorable (code de température le plus faible) peut être utilisé pour déterminer le code de température global du système. Les combinaisons d'équipements dans le système sont sujettes à inspection par les autorités locales qualifiées au moment de l'installation.</p>
<div style="display: flex; align-items: center;">  <div> <p><b>WARNING: EXPLOSION HAZARD</b></p> <ul style="list-style-type: none"> <li>• Do not disconnect equipment unless power has been removed or the area is known to be nonhazardous.</li> <li>• Do not disconnect connections to this equipment unless power has been removed or the area is known to be nonhazardous. Secure any external connections that mate to this equipment by using screws, sliding latches, threaded connectors, or other means provided with this product.</li> <li>• Substitution of any component may impair suitability for Class I, Division 2.</li> <li>• If this product contains batteries, they must only be changed in an area known to be nonhazardous.</li> </ul> </div> </div>	<div style="display: flex; align-items: center;">  <div> <p><b>AVERTISSEMENT: RISQUE D'EXPLOSION</b></p> <ul style="list-style-type: none"> <li>• Couper le courant ou s'assurer que l'environnement est classé non dangereux avant de débrancher l'équipement.</li> <li>• Couper le courant ou s'assurer que l'environnement est classé non dangereux avant de débrancher les connecteurs. Fixer tous les connecteurs externes reliés à cet équipement à l'aide de vis, loquets coulissants, connecteurs filetés ou autres moyens fournis avec ce produit.</li> <li>• La substitution de tout composant peut rendre cet équipement inadapté à une utilisation en environnement de Classe I, Division 2.</li> <li>• S'assurer que l'environnement est classé non dangereux avant de changer les piles.</li> </ul> </div> </div>

**WARNING:**

- If you insert or remove the module while power is on, an electrical arc can occur. This could cause an explosion in hazardous location installations. Be sure that power is removed or the area is nonhazardous before proceeding.
- The local programming terminal port is intended for temporary use only and must not be connected or disconnected unless the area is assured to be nonhazardous.
- When used in a Class I, Division 2, hazardous location, this equipment must be mounted in a suitable enclosure with proper wiring method that complies with the governing electrical codes.
- If you connect or disconnect wiring while the field-side power is on, an electrical arc can occur. This could cause an explosion in hazardous location installations. Be sure that power is removed or the area is nonhazardous before proceeding.
- The USB port is intended for temporary local programming purposes only and not intended for permanent connection. If you connect or disconnect the USB cable with power applied to this module or any device on the USB network, an electrical arc can occur. This could cause an explosion in hazardous location installations.  
Be sure that power is removed or the area is nonhazardous before proceeding.  
The USB port is a nonincendive field wiring connection for Class I, Division2 Groups A, B, C and D.
- Exposure to some chemicals may degrade the sealing properties of materials used in the Relays. It is recommended that the User periodically inspect these devices for any degradation of properties and replace the module if degradation is found.

**ATTENTION:**

- To comply with the CE Low Voltage Directive (LVD), this equipment must be powered from a source compliant with the following:  
Safety Extra Low Voltage (SELV) or Protected Extra Low Voltage (PELV).
  - To comply with UL restrictions, this equipment must be powered from a Class 2 or Limited Voltage Limited Current Source (LVLC).
-



**ATTENTION:**

- Do not wire more than 2 conductors on any single terminal.
  - Be careful when stripping wires. Wire fragments that fall into the controller could cause damage. Once wiring is complete, make sure the controller is free of all metal fragments.
  - Do not remove the protective debris strips until after the controller and all other equipment in the panel near the module are mounted and wired. Remove strips before operating the controller. Failure to remove strips before operating can cause overheating.
  - Electrostatic discharge can damage semiconductor devices inside the module. Do not touch the connector pins or other sensitive areas.
  - The USB cable is not to exceed 3.0 m (9.84 ft).
  - This product is intended to be mounted to a well-grounded mounting surface such as a metal panel. Additional grounding connections from the power supply's mounting tabs or DIN rail (if used) are not required unless the mounting surface cannot be grounded.  
Refer to Industrial Automation Wiring and Grounding Guidelines, Allen-Bradley publication [1770-4.1](#), for additional information.
- 

## Additional Resources

Resource	Description
Micro810 <sup>®</sup> Programmable Controllers User Manual, publication <a href="#">2080-UM001</a>	A more detailed description of how to install and use your Micro810 programmable controller.
Micro800 <sup>®</sup> AC Power Supply Installation Instruction, publication <a href="#">2080-IN001</a>	Information on wiring and installing the optional AC power supply.
Industrial Automation Wiring and Grounding Guidelines, publication <a href="#">1770-4.1</a>	More information on proper wiring and grounding techniques.

If you would like a manual, you can:

- download a free electronic version from the Internet:  
<http://literature.rockwellautomation.com>
- purchase a printed manual by contacting your local Allen-Bradley distributor or Rockwell Automation representative

## Overview

The Micro810 12-point controller is an economical brick-style controller with embedded inputs and outputs. It can accommodate a USB adapter, and an LCD module.

It can also accommodate any 24V DC output power supply that meets minimum specifications such as the optional Micro800® power supply (for 2080-LC10-12QWB and 2080-LC10-12QBB only), 2080-PS120-240VAC.

### Controller Overview

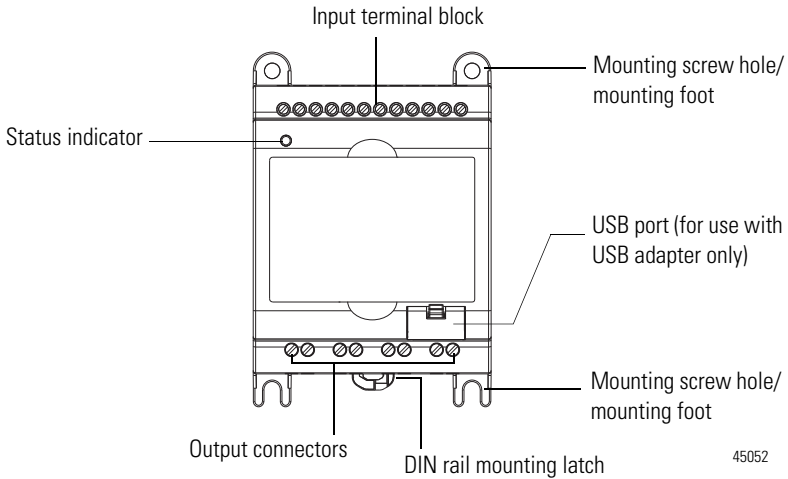

### Status Indicator

State	During normal operation	During firmware update or program/data transfer
Off	No power applied to device, or in Fault mode.	No power applied to device, or in Fault mode.
Solid green	Device operating normally.	Program transfer successful.
Flashing green	Operating system error.	Firmware update in progress.

## Mount the Module

Most applications require installation in an industrial enclosure to reduce the effects of electrical interference and environmental exposure. Locate your controller as far as possible from power lines, load lines, and other sources of electrical noise such as hard-contact switches, relays, and AC motor drives. For more information on proper grounding guidelines, see the Industrial Automation Wiring and Grounding Guidelines, publication [1770-4.1](#).

### Mounting Dimensions and DIN Rail Mounting

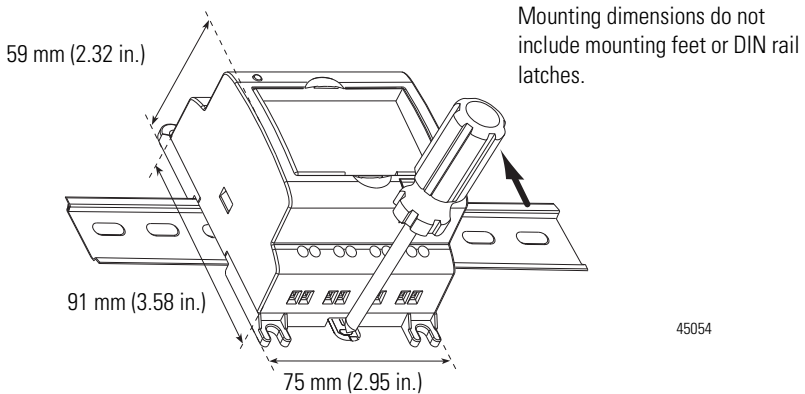

## Module Spacing

Maintain spacing from objects such as enclosure walls, wireways and adjacent equipment. Allow 50.8 mm (2 in.) of space on all sides for adequate ventilation.

## DIN Rail Mounting

The module can be mounted using the following DIN rails: 35 x 7.5 x 1 mm (EN 50 022 - 35 x 7.5).

Before mounting the module on a DIN rail, use a flat-blade screwdriver in the DIN rail latch and pry it downwards until it is in the unlatched position.

1. Hook the top of the DIN rail mounting area of the controller onto the DIN rail, and then press the bottom until the controller snaps onto the DIN rail.
2. Push the DIN rail latch back into the latched position.  
Use DIN rail end anchors (Allen-Bradley part number 1492-EA35 or 1492-EAHJ35) for vibration or shock environments.



To remove your controller from the DIN rail, pry the DIN rail latch downwards until it is in the unlatched position.

**TIP** For environments with greater vibration and shock concerns, use the panel mounting method, instead of DIN rail mounting.

## Panel Mounting

The preferred mounting method is to use four M4 (#8) screws per module. Hole spacing tolerance:  $\pm 0.4$  mm (0.016 in.).

Follow these steps to install your controller using mounting screws.

1. Place the controller against the panel where you are mounting it. Make sure the controller is spaced properly.
2. Mark drilling holes through the mounting screw holes and mounting feet then remove the controller.
3. Drill the holes at the markings, then replace the controller and mount it. Leave the protective debris strip in place until you are finished wiring the controller and any other devices.

### Panel Mounting Dimensions

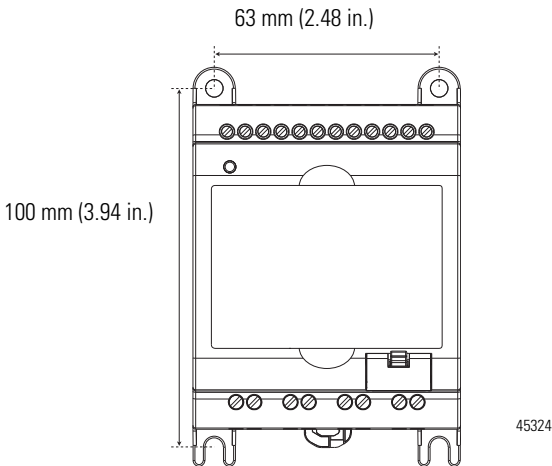

## Use Surge Suppressors

Because of the potentially high current surges that occur when switching inductive load devices, such as motor starters and solenoids, we recommend the use of some type of surge suppression to protect and extend the operating life of the controllers output contacts. Switching inductive loads without surge suppression can *significantly* reduce the life expectancy of relay contacts. By adding a suppression device directly across the coil of an inductive device, you prolong the life of the output or relay contacts. You also reduce the effects of voltage transients and electrical noise from radiating into adjacent systems.

Refer to the Micro810 Programmable Controllers User Manual, publication [2080-UM001](#), for suitable surge suppression methods and recommended surge suppressors.

# Wire the Controller

## 2080-LC10-12AWA

Input Terminal Block

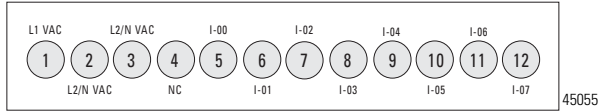

Output Terminal Block

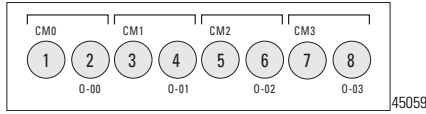

## 2080-LC10-12QWB

Input Terminal Block

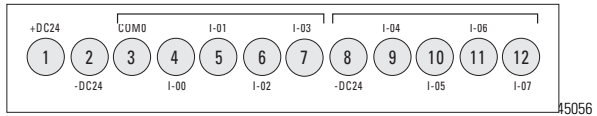

Output Terminal Block

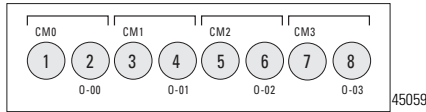

## 2080-LC10-12DWD

Input Terminal Block

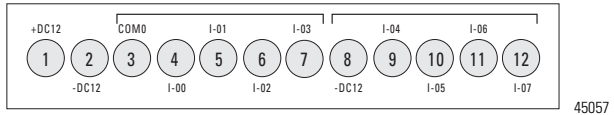

Output Terminal Block

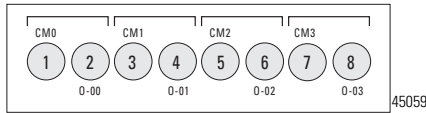

## 2080-LC10-12QBB

Input Terminal Block

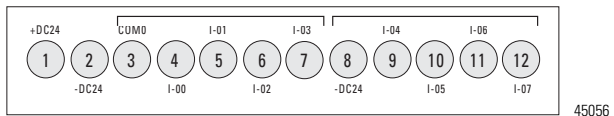

Output Terminal Block

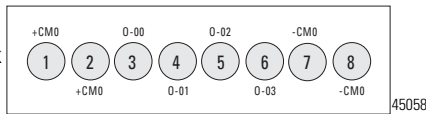

# Specifications

## General Specifications

Attribute	2080-LC10			
	12AWA	12QWB	12DWD	12QBB
Number of I/O	8 Input (4 digital, 4 analog/digital, configurable) 4 output			
Dimensions HxWxD	91 x 75 x 59 mm (3.58 x 2.95 x 2.32 in.)			
Supply voltage range	85V...263V	20.4...26.4V DC	10.8V...13.2V DC	11.4V...26.4V DC
	Class 2 or Limited Voltage Limited Current (LVLC) Source			
Supply frequency range (AC supply)	47...63 Hz	N.A.		
Voltage range	100...240V AC, 50/60 Hz	24V DC Class 2	12V DC Class 2	12/24V DC Class 2
Power consumption	5V A	5 W		
I/O rating	Input: 120...240V AC	Input: 24V DC, 8 mA	Input: 12V DC, 8 mA	Input: 24V DC, 8 mA Output: 24V DC 1A, 25 °C, 24V DC 0.5A 55°C
	Output: Relay 00 & 01: 8 A @ 240V AC, B300 General Use Relay 02 & 03: 4 A @ 240V AC, C300, R150, General Use			
Shipping weight, approx.	0.203 kg (0.448 lb)			
Wire size				
		<b>Min</b>	<b>Max</b>	rated @ 90 °C (194 °F ) insulation max
	Solid	0.32 mm <sup>2</sup> (22 AWG)	2.1 mm <sup>2</sup> (14 AWG)	
Stranded	0.32 mm <sup>2</sup> (22 AWG)	1.3 mm <sup>2</sup> (16 AWG)		
Wiring category <sup>(1)</sup>	2 – on signal ports 2 – on power ports			
Wiring torque	1.085 Nm (8 lb-in.)			
Wire type	use Copper Conductors only			
Fuse, type	Rated 250V 3.15 A-RADIAL			
Enclosure type rating	Meets IP20			

**General Specifications**

Attribute	2080-LC10			
	12AWA	12QWB	12DWD	12QBB
North American temp code	T5			
Insulation stripping length	7 mm (0.28 in.)			
Isolation voltage	250V (continuous), Reinforced Insulation Type, I/O to Aux and Network, Inputs to Outputs. Type tested for 60 s @ 3250V DC, I/O to Aux and Network, Inputs to Outputs	250V (continuous), Reinforced Insulation Type, I/O to Aux and Network, Inputs to Outputs Type tested for 60 s @ 720V DC, Inputs to Aux and Network, 3250V DC Outputs to Aux and Network, Inputs to Outputs		50V (continuous), Reinforced Insulation Type, I/O to Aux and Network, Inputs to Outputs Type tested for 60 s @ 720V DC, I/O to Aux and Network, Inputs to Outputs
AC input filter setting	16 ms for all embedded inputs Through the Connected Components Workbench software, go to the Embedded I/O configuration window to re-configure the filter setting for each input group.			

<sup>(1)</sup> Use this Conductor Category information for planning conductor routing. Refer to Industrial Automation Wiring and Grounding Guidelines, publication [1770-4.1](#).

**Non-isolated AC Inputs (2080-LC10-12AWA)**

Attribute	Value
On-state voltage, nom	120/240 V AC
On-state voltage, min	79 V AC
On-state voltage, max	265 V AC
Off-state voltage, max	40 V AC
Operating frequency, nom	50/60 Hz
Input impedance	423.7 k $\Omega$
Operating frequency	47...63 Hz

**DC Inputs (2080-LC10-12QWB, 2080-LC10-12QBB, 2080-LC10-12DWD)**

Attribute	Non-isolated inputs, shared with analog inputs (Inputs 4...7)	Isolated inputs (Inputs 0...3)
Voltage category	24V DC sink/source	
On-state voltage, nom	12/24V DC	
On-state voltage, min	9.8V DC	
On-state voltage, max	28.8V AC	
Off-state voltage, max	5V DC	
Off-state current, max	0.5 mA	1.5 mA
On-state current, min	0.75 mA @ 10.8V DC 1.0 mA @ 15 V DC	1.8 mA @ 10.8V DC 2.7 mA @ 15 V DC
On-state current, nom	2.1 mA @ 24V DC	6 mA @ 24V DC
On-state current, max	2.7 mA @ 28.8 V DC	7.5 mA @ 28.8 V DC
Nominal impedance	14.1 k $\Omega$	3.74 k $\Omega$ (isolated)
IEC input compatibility	Type 1	Type 3

**Analog Inputs (2080-LC10-12QWB, 2080-LC10-12QBB, 2080-LC10-12DWD) (Inputs 4...7)**

Attribute	Value
Input type	DC voltage
Input voltage range	0...10V DC
Input voltage, max	26.4V DC
Value of LSB	10 mV
Input resolution	10-bit
Filtering	None (12-bits truncated to 10-bits for smoothing)
Overall accuracy	5% of full-scale (2% with calibration) (25...55 °C) (77...131 °F)
Noise rejection	50/60 Hz
Common mode rejection	40 dB, DC to 60 Hz with smoothing filter
Nominal impedance	14.1 k $\Omega$ (non-isolated)

**DC Output (2080-LC10-12QBB)**

Attribute	Value
User supply voltage, min	10 V DC
User supply voltage, max	26.4V DC
On-state voltage drop	1V @ max load current 2.5V @ max surge current
Current ratings (each point)	0.5A @ 55 °C max 1.0A @ 25 °C max 1.0 mA min
Controller current	3 A
Surge current, peak	4.0 A
Surge current, max duration	10 ms
Turn-on- time, max	0.1 ms
Turn-off time, max	1.0 ms

**Relay Outputs ((2080-LC10-12AWA, 2080-LC10-12QWB, 2080-LC10-12DWD)**

Attribute	Value
Output rating	Relay 00 & 01: 8 A @ 240V AC, 5A @ 24V DC, B300 Relay 02 & 03: 4 A @ 240V AC, 2A @ 24V DC, C300, R150
Voltage, min	5V AC/DC
Voltage, max	250V AC, 30V DC @ rated current
Turn on time	15 ms
Turn off time	5 ms

For more specifications, refer to the Micro810 Programmable Controllers User Manual, publication [2080-UM001](#).

**Environmental Specifications**

Attribute	Value
Temperature, operating	IEC 60068-2-1 (Test Ad, Operating Cold), IEC 60068-2-2 (Test Bd, Operating Dry Heat), IEC 60068-2-14 (Test Nb, Operating Thermal Shock): 0...55 °C (32...131 °F)
Temperature, surrounding air, max	55 °C (131 °F)

## Environmental Specifications

Attribute	Value
Temperature, storage	IEC 60068-2-1 (Test Ab, Unpackaged Non-operating Cold), IEC 60068-2-2 (Test Bb, Unpackaged Non-operating Dry Heat), IEC 60068-2-14 (Test Na, Unpackaged Non-operating Thermal Shock): -40...85 °C (-40...185 °F)
Relative humidity	IEC 60068-2-30 (Test Db, Unpackaged Damp Heat): 5...95% non-condensing
Vibration	IEC 60068-2-6 (Test Fc, Operating): 2 g @ 10...500 Hz
Shock, operating	IEC 60068-2-27 (Test Ea, Unpackaged Shock): 30 g
Shock, nonoperating	IEC 60068-2-27 (Test Ea, Unpackaged Shock): 30 g (DIN Rail Mounted) 30 g (Panel Mounted)
Emissions	CISPR 11 Group 1, Class A
ESD immunity	IEC 61000-4-2: 4 kV contact discharges 8 kV air discharges
Radiated RF immunity	IEC 61000-4-3: 10V/m with 1 kHz sine-wave 80% AM from 80...2000 MHz 10V/m with 200 Hz 50% Pulse 100% AM at 900 MHz 10V/m with 200 Hz 50% Pulse 100% AM at 1890 MHz 3V/m with 1 kHz sine-wave 80% AM from 2000...2700 MHz
EFT/B immunity	IEC 61000-4-4: ±2 kV at 5 kHz on power ports ±2 kV at 5 kHz on signal ports
Surge transient immunity	IEC 61000-4-5: ±1 kV line-line(DM) and ±2 kV line-earth(CM) on power ports ±1 kV line-line(DM) and ±2 kV line-earth(CM) on signal ports ±2 kV line-earth(CM) on shielded ports
Conducted RF immunity	IEC 61000-4-6: 10V rms with 1 kHz sine-wave 80% AM from 150 kHz...80 MHz
Voltage variation	IEC 61000-4-11: 60% dip for 5 and 50 periods on AC supply ports 30% dip for 0.5 period @ 0° and 180° on AC supply ports 100% dip for 0.5 period @ 0° and 180° on AC supply ports ±10% fluctuations for 15 min on AC supply ports >95% interruptions for 250 periods on AC supply ports



## Certifications

Certification (when product is marked) <sup>(1)</sup>	Value
c-UL-us	UL Listed Industrial Control Equipment, certified for US and Canada. See UL File E322657.  UL Listed for Class I, Division 2 Group A,B,C,D Hazardous Locations, certified for U.S. and Canada. See UL File E334470.
CE	European Union 2004/108/EC EMC Directive, compliant with: EN 61000-6-2; Industrial Immunity EN 61000-6-4; Industrial Emissions EN 61131-2; Programmable Controllers (Clause 8, Zone A & B) EN 61131-2; Programmable Controllers (Clause 11)
C-Tick	Australian Radiocommunications Act, compliant with: AS/NZS CISPR 11; Industrial Emissions
KC	Korean Registration of Broadcasting and Communications Equipment, compliant with: Article 58-2 of Radio Waves Act, Clause 3

<sup>(1)</sup> See the Product Certification link at <http://www.rockwellautomation.com/products/certification> for Declaration of Conformity, Certificates, and other certification details.

**Notes:**

## **Notes:**

# Rockwell Automation Support

Rockwell Automation provides technical information on the Web to assist you in using its products. At <http://support.rockwellautomation.com>, you can find technical manuals, a knowledge base of FAQs, technical and application notes, sample code and links to software service packs, and a MySupport feature that you can customize to make the best use of these tools.

For an additional level of technical phone support for installation, configuration and troubleshooting, we offer TechConnect support programs. For more information, contact your local distributor or Rockwell Automation representative, or visit <http://support.rockwellautomation.com>.

## Installation Assistance

If you experience a problem within the first 24 hours of installation, please review the information that's contained in this manual. You can also contact a special Customer Support number for initial help in getting your product up and running.

United States	1.440.646.3434 Monday – Friday, 8 a.m. – 5 p.m. EST
Outside United States	Please contact your local Rockwell Automation representative for any technical support issues.

## New Product Satisfaction Return

Rockwell Automation tests all of its products to ensure that they are fully operational when shipped from the manufacturing facility. However, if your product is not functioning and needs to be returned, follow these procedures.

United States	Contact your distributor. You must provide a Customer Support case number (call the phone number above to obtain one) to your distributor in order to complete the return process.
Outside United States	Please contact your local Rockwell Automation representative for the return procedure.

Allen-Bradley, Rockwell Automation, Micro800, Micro810, and TechConnect are trademarks of Rockwell Automation, Inc.

Trademarks not belonging to Rockwell Automation are property of their respective companies.

Rockwell Otomasyon Ticaret A.Ş., Kar Plaza İş Merkezi E Blok Kat:6 34752 İçerenköy, İstanbul, Tel: +90 (216) 5698400

[www.rockwellautomation.com](http://www.rockwellautomation.com)

### Power, Control and Information Solutions Headquarters

Americas: Rockwell Automation, 1201 South Second Street, Milwaukee, WI 53204-2496 USA, Tel: (1) 414.382.2000, Fax: (1) 414.382.4444  
Europe/Middle East/Africa: Rockwell Automation, Voortlaan/Boulevard du Souverain 36, 1170 Brussels, Belgium, Tel: (32) 2.663.0800, Fax: (32) 2.663.0640  
Asia Pacific: Rockwell Automation, Level 14, Core F, Cyberport 3, 100 Cyberport Road, Hong Kong, Tel: (852) 2887 4788, Fax: (852) 2508 1846

Publication 2080-IN006B-EN-P - April 2014

Supersedes Publication 2080-IN006A-EN-P - September 2010

PN-244665

Copyright © 2014 Rockwell Automation, Inc. All rights reserved. Printed in Singapore.