



FLEX XT I/O Isolated Input Analog Module

Cat. No. 1794-IF4ICFXT

Important User Information

Solid state equipment has operational characteristics differing from those of electromechanical equipment. Safety Guidelines for the Application, Installation and Maintenance of Solid State Controls (Publication SGI-1.1, available from your local Rockwell Automation sales office or online at <http://literature.rockwellautomation.com>) describes some important differences between solid state equipment and hard-wired electromechanical devices. Because of this difference, and also because of the wide variety of uses for solid state equipment, all persons responsible for applying this equipment must satisfy themselves that each intended application of this equipment is acceptable.



In no event will Rockwell Automation, Inc. be responsible or liable for indirect or consequential damages resulting from the use or application of this equipment.

The examples and diagrams in this manual are included solely for illustrative purposes. Because of the many variables and requirements associated with any particular installation, Rockwell Automation, Inc. cannot assume responsibility or liability for actual use based on the examples and diagrams.

No patent liability is assumed by Rockwell Automation, Inc. with respect to use of information, circuits, equipment, or software described in this manual.

Reproduction of the contents of this manual, in whole or in part, without written permission of Rockwell Automation, Inc., is prohibited.









Throughout this manual we use notes to make you aware of safety considerations.

	WARNING	Identifies information about practices or circumstances that can cause an explosion in a hazardous environment, which may lead to personal injury or death, property damage, or economic loss.
	ATTENTION	Identifies information about practices or circumstances that can lead to personal injury or death, property damage, or economic loss. Attentions help you: <ul style="list-style-type: none"> • identify a hazard • avoid a hazard • recognize the consequence
	IMPORTANT	Identifies information that is critical for successful application and understanding of the product.

	ATTENTION	Environment and Enclosure This equipment is intended for use in a Pollution Degree 2 industrial environment, in overvoltage Category II applications (as defined in IEC 60664-1), at altitudes up to 2000 m (6562 ft) without derating. This equipment is considered Group 1, Class A industrial equipment according to IEC/CISPR 11. Without appropriate precautions, there may be difficulties with electromagnetic compatibility in residential and other environments due to conducted and radiated disturbances. This equipment is supplied as open-type equipment. It must be mounted within an enclosure that is suitably designed for those specific environmental conditions that will be present and appropriately designed to prevent personal injury resulting from accessibility to live parts. The enclosure must have suitable flame-retardant properties to prevent or minimize the spread of flame, complying with a flame spread rating of 5VA, V2, V1, V0 (or equivalent) if non-metallic. The interior of the enclosure must be accessible only by the use of a tool. Subsequent sections of this publication may contain additional information regarding specific enclosure type ratings that are required to comply with certain product safety certifications. In addition to this publication, see: <ul style="list-style-type: none"> • Industrial Automation Wiring and Grounding Guidelines, Rockwell Automation publication 1770-4.1, for additional installation requirements. • NEMA Standard 250 and IEC 60529, as applicable, for explanations of the degrees of protection provided by different types of enclosure.
---	------------------	--

	WARNING	If you insert or remove the module while backplane power is on, an electrical arc can occur. This could cause an explosion in hazardous location installations. Be sure that power is removed or the area is nonhazardous before proceeding.
---	----------------	--

Installation Instructions

	WARNING	If you connect or disconnect wiring while the field side power is on, an electrical arc can occur. This could cause an explosion in hazardous location installations. Be sure that power is removed or the area is nonhazardous before proceeding.
	ATTENTION	FLEX I/O is grounded through the DIN rail to chassis ground. Use zinc plated yellow-chromate steel DIN rail to assure proper grounding. The use of other DIN rail materials (for example, aluminum or plastic) that can corrode, oxidize, or are poor conductors, can result in improper or intermittent grounding. Secure DIN rail to mounting surface approximately every 200 mm (7.8 in.) and use end-anchors appropriately.
	ATTENTION	Prevent Electrostatic Discharge This equipment is sensitive to electrostatic discharge, which can cause internal damage and affect normal operation. Follow these guidelines when you handle this equipment: <ul style="list-style-type: none"> • Touch a grounded object to discharge potential static. • Wear an approved grounding wriststrap. • Do not touch connectors or pins on component boards. • Do not touch circuit components inside the equipment. • Use a static-safe workstation, if available. • Store the equipment in appropriate static-safe packaging when not in use.
	ATTENTION	Do not substitute a 1794-IF4I or 1794-IF4IXT with the 1794-IF4ICFXT, as this will force a remapping of IO and configuration data.
	ATTENTION	Personnel responsible for the application of safety-related programmable electronic systems (PES) shall be aware of the safety requirements in the application of the system and shall be trained in using the system.
	ATTENTION	To comply with the CE Low Voltage Directive (LVD), all connections to this equipment must be powered from a source compliant with the following: Safety Extra Low Voltage (SELV) or Protected Extra Low Voltage (PELV).
	ATTENTION	Do not remove or replace a Terminal Base unit while power is applied. Interruption of the backplane can result in unintentional operation or machine motion.
	ATTENTION	Personnel responsible for the application of safety-related programmable electronic systems (PES) shall be aware of the safety requirements in the application of the system and shall be trained in using the system.
European Hazardous Location Approval		
European Zone 2 Certification (The following applies when the product bears the Ex or EEx Marking)		
This equipment is intended for use in potentially explosive atmospheres as defined by European Union Directive 94/9/EC and has been found to comply with the Essential Health and Safety Requirements relating to the design and construction of Category 3 equipment intended for use in potentially explosive atmospheres, given in Annex II to this Directive. Compliance with the Essential Health and Safety Requirements has been assured by compliance with EN 60079-15 and EN 60079-0.		

WARNING

Observe the following additional Zone 2 certification requirements.

- This equipment is not resistant to sunlight or other sources of UV radiation.
- This equipment must be installed in an enclosure providing at least IP54 protection when applied in Zone 2 environments.
- This equipment shall be used within its specified ratings defined by Allen-Bradley.
- Provision shall be made to prevent the rated voltage from being exceeded by transient disturbances of more than 40% when applied in Zone 2 environments.
- Secure any external connections that mate to this equipment by using screws, sliding latches, threaded connectors, or other means provided with this product.
- Do not disconnect equipment unless power has been removed or the area is known to be nonhazardous.

North American Hazardous Location Approval

The following adapters are North American Hazardous Location approved: 1794-IF4ICFXT

The following information applies when operating this equipment in hazardous locations:	Informations sur l'utilisation de cet équipement en environnements dangereux :
Products marked "CL 1, DIV 2, GP A, B, C, D" are suitable for use in Class I Division 2 Groups A, B, C, D, Hazardous Locations and nonhazardous locations only. Each product is supplied with markings on the rating nameplate indicating the hazardous location temperature code. When combining products within a system, the most adverse temperature code (lowest "T" number) may be used to help determine the overall temperature code of the system. Combinations of equipment in your system are subject to investigation by the local Authority Having Jurisdiction at the time of installation.	Les produits marqués "CL 1, DIV 2, GP A, B, C, D" ne conviennent qu'à une utilisation en environnements de Classe I Division 2 Groupes A, B, C, D dangereux et non dangereux. Chaque produit est livré avec des marquages sur sa plaque d'identification qui indiquent le code de température pour les environnements dangereux. Lorsque plusieurs produits sont combinés dans un système, le code de température le plus défavorable (code de température le plus faible) peut être utilisé pour déterminer le code de température global du système. Les combinaisons d'équipements dans le système sont sujettes à inspection par les autorités locales qualifiées au moment de l'installation.
WARNING	AVERTISSEMENT
EXPLOSION HAZARD	RISQUE D'EXPLOSION
<ul style="list-style-type: none"> • Do not disconnect equipment unless power has been removed or the area is known to be nonhazardous. • Do not disconnect connections to this equipment unless power has been removed or the area is known to be nonhazardous. Secure any external connections that mate to this equipment by using screws, sliding latches, threaded connectors, or other means provided with this product. • Substitution of components may impair suitability for Class I, Division 2. • If this product contains batteries, they must only be changed in an area known to be nonhazardous. 	<ul style="list-style-type: none"> • Couper le courant ou s'assurer que l'environnement est classé non dangereux avant de débrancher l'équipement. • Couper le courant ou s'assurer que l'environnement est classé non dangereux avant de débrancher les connecteurs. Fixer tous les connecteurs externes reliés à cet équipement à l'aide de vis, loquets coulissants, connecteurs filetés ou autres moyens fournis avec ce produit. • La substitution de composants peut rendre cet équipement inadapté à une utilisation en environnement de Classe I, Division 2. • S'assurer que l'environnement est classé non dangereux avant de changer les piles.

About the module

In addition to the features supported by the 1794-IF4I and 1794-IF4IXT modules, the 1794-IF4ICFXT features three additional parameters that allow additional control over the way the analog signals are processed by the module. The settings are at the module level.

Settings to these parameters affect all inputs set to 150 Hz, 300 Hz, or 600 Hz. The parameters do not affect channels set at 1200 Hz.

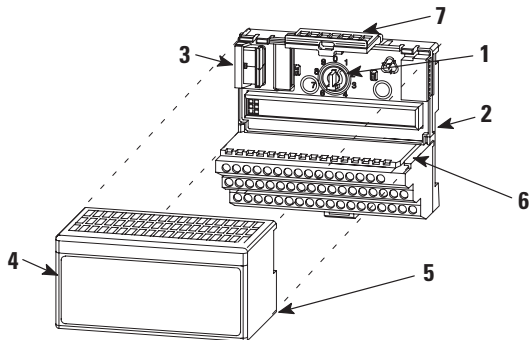
Install Your Analog Input Module**ATTENTION**

During mounting of all devices, be sure that all debris (such as metal chips, or wire strands) is kept from falling into the module. Debris that falls into the module could cause damage on power up.

Keep a minimum of 25 mm (1 in.) of space on the top and bottom of the module, for adequate ventilation between equipment.

The module mounts on a 1794 terminal base.

1. Rotate the keyswitch (1) on the terminal base (2) clockwise to position 3 as required for 1794-IF4ICFXT.
2. Make certain the flexbus connector (3) is pushed all the way to the left to connect with the neighboring terminal base/adaptor.
You cannot install the module unless the connector is fully extended.
3. Make sure the pins on the bottom of the module are straight so they will align properly with the connector in the terminal base.
4. Position the module (4) with its alignment bar (5) aligned with the groove (6) on the terminal base.
5. Press firmly and evenly to seat the module in the terminal base unit. The module is seated when the latching mechanism (7) is locked into the module.

Connect Wiring for Analog Inputs and Outputs

1. **1794-TB2, 1794-TB3, 1794-TB3S, 1794-TB3T, 1794-TB3TS** - Connect individual input/output wiring to numbered terminals on the 0-15 row (A) as indicated in the Wire Connections table. Use Belden 8761 cable for signal wiring.
1794-TBN - Connect individual input/output wiring to even numbered terminals on the 16-33 row (B) as indicated in the following table. Use Belden 8761 cable for signal wiring.

ATTENTION

Connect only one current or one voltage signal per channel. Do not connect both current and voltage on one channel.

2. **1794-TB2, -TB3, -TB3S, -TB3T, -TB3TS** - Connect each channel signal return to numbered terminals on 0-15 row (A) as indicated in the following table. Use Belden 8761 cable for signal wiring.
1794-TBN - Connect each channel signal return to odd numbered terminals on row (C) as indicated in the following table.
3. Connect any signal wiring shields to functional ground as near as possible to the module.
1794-TB3T or -TB3TS only: Connect cable shield to terminate C-39 through C-46 (earth ground).
4. Connect the +V DC power to terminal 34 on the 34-51 row (C) and -V common/return to terminal 16 on the B row.

ATTENTION

To reduce susceptibility to noise, power analog modules and digital modules from separate power supplies.

5. If daisy chaining +V power to the next terminal base, connect a jumper from terminal 51 (+V DC) on this base unit to terminal 34 on the next base unit.
6. If continuing DC common (-V) to the next base unit, connect a jumper from terminal 33 (common) on this base unit to terminal 16 on the next base unit.

Wire Connections for 1794-IF4ICFXT Modules

Channel	Signal Type	Label Markings	1794-TB2, -TB3, -TB3S, -TB3T, -TB3TS		1794-TBN	
			Terminal	Shield (1794-TB3T, -TB3TS)	Terminal	
Input 0	Current	I0	A-0	C-39	B-0	
	Current	I0 Ret	A-1		C-1	
	Voltage	V0	A-2		C-40	B-2
	Voltage	V0 Ret	A-3		C-3	C-3
Input 1	Current	I1	A-4	C-41	B-4	
	Current	I1 Ret	A-5		C-5	
	Voltage	V1	A-6		C-42	B-6
	Voltage	V1 Ret	A-7		C-7	C-7
Output 0	Current	I2	A-8	C-43	B-8	
	Current	I2 Ret	A-9		C-9	
	Voltage	V2	A-10		C-44	B-10
	Voltage	V2 Ret	A-11		C-11	C-11
Output 1	Current	I3	A-12	C-45	B-12	
	Current	I3 Ret	A-13		C-13	
	Voltage	V3	A-14		C-46	B-14
	Voltage	V3 Ret	A-15		C-15	C-15
-V DC Common	1794-TB2, -TB3, -TB3S - Terminals B-16 through B-33 are internally connected in the terminal base unit. 1794-TBN - Terminals B-16 and B-33 are internally connected in the terminal base unit. 1794-TB3T, -TB3TS - Terminals 16, 17, 19, 21, 23, 25, 27, 29, 31 and 33 are internally connected in the terminal base unit.					
+V DC Power	1794-TB3, -TB3S - Terminals 34 through 51 are internally connected in the terminal base unit. 1794-TB3T, -TB3TS - Terminals 34, 35, 50 and 51 are internally connected in the terminal base unit. 1794-TBN, -TB2 - Terminals 34 and 51 are internally connected in the terminal base unit.					
Chassis Ground (Shield)	1794-TB3T, -TB3TS - Terminals 39 through 46 are internally connected to chassis ground.					

7. 1794-TB2, -TB3, and -TB3S - Connect wiring shields to functional earth ground as near as possible to the module.

1794-TB2, 1794-TB3, 1794-TB3S, 1794-TB3T and 1794-TB3TS Terminal Base Wiring

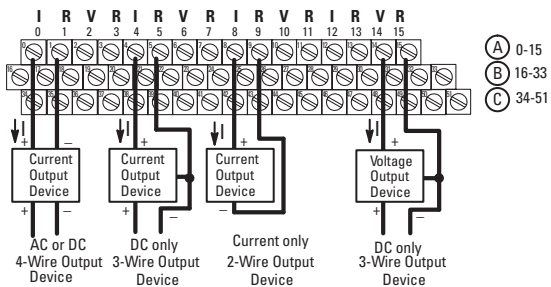

1794-TBN Terminal Base Wiring

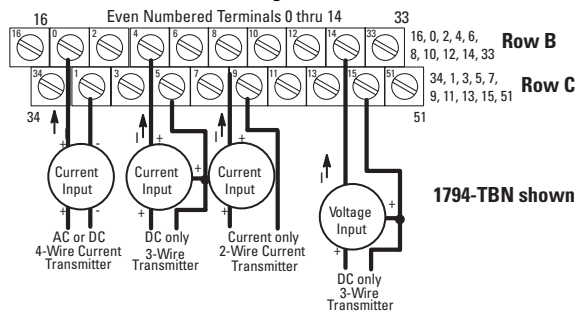

Input Map

Dec.	15	14	13	12	11	10	9	8	7	6	5	4	3	2	1	0
Oct.	17	16	15	14	13	12	11	10	7	6	5	4	3	2	1	0
Word 0	Analog Value Channel 0															
Word 1	Analog Value Channel 1															
Word 2	Analog Value Channel 2															
Word 3	Analog Value Channel 3															
Word 4	Real Time Sample															

Dec.	15	14	13	12	11	10	9	8	7	6	5	4	3	2	1	0	
Oct.	17	16	15	14	13	12	11	10	7	6	5	4	3	2	1	0	
Word 5	PU	FP	CF	0	Reserved				0	0	0	0	0	0	BD	DN	0
Word 6	0	0	0	0	0	0	0	0	0	V3	V2	V1	V0	U3	U2	U1	U0

Where:
 PU = Power up unconfigured
 FP = Field power off
 CF = In configuration mode
 BD = Bad calibration
 DN = Calibration accepted
 U = Underrange for specified channel
 V = Overrange for specified channel

Output Map

Dec.	15	14	13	12	11	10	9	8	7	6	5	4	3	2	1	0
Oct.	17	16	15	14	13	12	11	10	7	6	5	4	3	2	1	0
Word 0	EN	0	0	0	0	0	0	0	0	0	0	0	0	0	0	0
Word 1	Channel 3 Filter				Channel 2 Filter				Channel 1 Filter				Channel 0 Filter			
Word 2	Ch 3 Configuration				Ch 2 Configuration				Ch 1 Configuration				Ch 0 Configuration			
Word 3	Real Time Sample Interval															
Word 4	IC	1	TR	IT	0	CH	SK	FS	RV	QK	CK	GO	Channel Number			
Word 5	Reserved															

Where:
 EN = Enable bit (not used on input module)
 IC = Initiate Configuration bit
 TR = Transparent bit
 IT = Interrupt toggle bit
 CH = Chop Mode Disable — use to disable the chop mode. Chop mode used by the module to reduce offset and drift errors. The default is chop mode enabled (0).
 SK = FIR Filter Disable — use to disable the FIR filter. The Finite Impulse Response filter is used by the module to improve signal stability. The default is FIR filter enabled (0).
 FS = Fast Step Response — use to enable a fast step response algorithm. The fast step response algorithm, upon sensing a step input, uses an averaging method rather than the FIR filter. The FIR goes back into operation once the input has settled. The default is fast step response disabled (0).
 RV = Revert to default bit
 QK = Quick calibration
 CK = Calibration clock
 GO = Gain Offset select

Configure Your Input Channels

Input Channel Configuration

03	02	01	00	Set these bits for channel 0
07	06	05	04	Set these bits for channel 1
11	10	09	08	Set these bits for channel 2
15	14	13	12	Set these bits for channel 3

Bit Settings				Input Values	Data Format	% Underrange % Overrange	Input Range
0	0	0	0	Channel not configured			
0	0	0	1	4...20 mA	signed 2's complement	4% under; 4% over	<-0000..7878>
0	0	1	0	±10V		2% under; 2% over	<-831F..7CE1>
0	0	1	1	±5V		4% under; 4% over	<-8618..79E8>
0	1	0	0	0...20 mA	signed 2's complement %	0% under; 4% over	<0...10000>
0	1	0	1	4...20 mA		4% under; 4% over	<0...10000>
0	1	1	0	0...10V		0% under; 2% over	<0...10000>
0	1	1	1	±10V		2% under; 2% over	<-10000...10000>
1	0	0	0	0...20 mA	binary	0% under; 4% over	<0000...F3CF>
1	0	0	1	4...20 mA		4% under; 4% over	<0000...F0F1>
1	0	1	0	0...10V		0% under; 2% over	<0000...F9C2>
1	0	1	1	0...5V		0% under; 4% over	<0000...F3CF>
1	1	0	0	±20 mA	offset binary, 8000H = 0 mA	4% under; 4% over	<0618...F9E8>
1	1	0	1	4...20 mA	offset binary, 8000H = 4 mA	4% under; 4% over	<8000...F878>
1	1	1	0	±10V	offset binary,	2% under; 2% over	<031F...FCE1>
1	1	1	1	±5V	8000H = 0 mA	4% under; 4% over	<0618...F9E8>

Input Update Rate for Real Time Sample Interval = 0

Configuration Bits				Input Nominal Ranges	Channel Update Rate ⁽¹⁾ RTSI = 0 and No low pass filter	Channel Update Rate ⁽¹⁾ RTSI and Filter = 0 IT bit = 1
MSD	LSD					
0	0	0	1	4...20 mA	7.5 ms	5.0 ms
0	0	1	0	±10V	2.5 ms	2.5 ms
0	0	1	1	±5V	2.5 ms	2.5 ms
0	1	0	0	0...20 mA	7.5 ms	5.0 ms
0	1	0	1	4...20 mA	7.5 ms	5.0 ms
0	1	1	0	0...10V	5.0 ms	5.0 ms
0	1	1	1	±10V	5.0 ms	5.0 ms
1	0	0	0	0...20 mA	2.5 ms	2.5 ms
1	0	0	1	4...20 mA	7.5 ms	5.0 ms
1	0	1	0	0...10V	2.5 ms	2.5 ms
1	0	1	1	0...5V	2.5 ms	2.5 ms
1	1	0	0	±20 mA	2.5 ms	2.5 ms

1	1	0	1	4...20 mA	7.5 ms	5.0 ms
1	1	1	0	±10V	2.5 ms	2.5 ms
1	1	1	1	±5V	2.5 ms	2.5 ms

⁽¹⁾ When IT = 1, the channel update rate for all channels is determined by the slowest channel.

Set the Input Filters

Input Channel Configuration

03	02	01	00	Set these bits for channel 0	
07	06	05	04	Set these bits for channel 1	
11	10	09	08	Set these bits for channel 2	
15	14	13	12	Set these bits for channel 3	
Bit Settings				A/D Conversion Rate	Low Pass Filter
0	0	0	0	1200 Hz	No low pass
0	0	0	1	1200 Hz	100 ms low pass
0	0	1	0	1200 Hz	500 ms low pass
0	0	1	1	1200 Hz	1000 ms low pass
0	1	0	0	600 Hz	No low pass
0	1	0	1	600 Hz	100 ms low pass
0	1	1	0	600 Hz	500 ms low pass
0	1	1	1	600 Hz	1000 ms low pass
1	0	0	0	300 Hz	No low pass
1	0	0	1	300 Hz	100 ms low pass
1	0	1	0	300 Hz	500 ms low pass
1	0	1	1	300 Hz	1000 ms low pass
1	1	0	0	150 Hz	No low pass
1	1	0	1	150 Hz	100 ms low pass
1	1	1	0	150 Hz	500 ms low pass
1	1	1	1	150 Hz	1000 ms low pass

Power/status Indicator

The OK status indicator is bicolor red and green. The indicator flashes green for any of the following 3 reasons:

1. The module configuration word is zero (for example, powerup reset condition).
2. The 24V DC user power is off.
3. The module is in configuration mode.

The indicator displays red to indicate the module did not pass the initial hardware test. Recycle power.

After powerup, if the status indicator is not flashing green or solid green, recycle module power to verify a proper reset of the bus interface.

Specifications

General

Attribute	Value
Module location	Cat. No. 1794-TB2, 1794-TB3, 1794-TB3S, 1794-TB3T, 1794-TB3TS, and 1794-TBN
Number of inputs	4 isolated
Resolution Voltage Current	16 bits - unipolar; 15 bits plus sign - bipolar 0.156 mV/cnt unipolar; 0.313 mV/cnt bipolar 0.320 μ A/cnt unipolar; 0.640 μ A/cnt bipolar
Update rate	2.5/5.0/7.5 ms all channels (see input update rate table)
Input current terminal	4...20 mA (user configurable) 0...20 mA (user configurable) \pm 20 mA (user configurable)
Input voltage terminal	\pm 10V (user configurable) 0...10V (user configurable) \pm 5V (user configurable) 0...5V (user configurable)
Input Resistance Voltage terminal Current terminal	>10 M Ω <100 Ω ⁽³⁾
Data format	2's complement 2's complement % binary offset binary
Conversion type	Sigma Delta
Update rate	2.5/5.0/7.5 ms all channels (see input update rate table)
Normal mode rejection ratio - voltage or current Terminal	-3 dB @ 12 Hz (300 Hz conversion rate) -80 dB @ 50 Hz (300 Hz conversion rate) -3 dB @ 6 Hz (150 Hz conversion rate) -80 dB @ 60 Hz (150 Hz conversion rate)

General

Attribute	Value
Common mode rejection ratio	-120 dB @ 50/60 Hz
Step response to 63% - voltage or current terminal	1200 Hz conversion rate = 0.6 ms 600 Hz conversion rate = 0.67 ms 300 Hz conversion rate = 13.4 ms 150 Hz conversion rate = 26.7 ms
Absolute accuracy ⁽¹⁾ voltage terminal current terminal	0.1% Full Scale @ 25 °C 0.1% Full Scale @ 25 °C
Accuracy drift with temperature Voltage terminal Current terminal	0.0028% Full Scale/°C 0.0038% Full Scale/°C
Calibration required	Factory calibrated. Can be calibrated in field when necessary
Maximum overload	30V continuous or 32 mA continuous, one channel at a time.
Indicators	1 red/green power/status indicator
Isolation voltage	120V (continuous), Basic Insulation Type, when used with 1794-TB2, 1794-TB3, 1794-TB3S, 1794-TB3T, or 1794-TB3TS 250V (continuous), Basic Insulation Type, when used with 1794-TBN Type tested at 1500V AC for 60 s and Routine tested at 2550V DC for 1 s, between channel to power, channel to system, and power to system, and channel to channel
Flexbus current	50 mA
Power dissipation	2.0 W maximum @ 31.2V DC
Thermal dissipation	Maximum 6.8 BTU/hr @ 31.2V DC
Keyswitch position	3
External DC Power Supply voltage Voltage range Supply current	24V DC nominal SUPPLY: 19.2-31.2V DC, 80 mA FLEXBUS: 5V DC, 50 mA Input: 0...20 mA, \pm 10V DC
Dimensions	46 mm x 94 mm x 75 mm (1.8 in. x 3.7 in. x 2.95 in.) with module installed in base
Wire size	Determined by installed terminal base
Wiring category ⁽²⁾	2 - on signal ports 2 - on power ports
Wire type	Shielded on signal ports
Enclosure type rating	None (open-style)
Terminal screw torque	Determined by installed terminal base
North American temp code	T4
IEC temp code	T4

⁽¹⁾ Includes offset, gain, nonlinearity and repeatability error terms.

⁽²⁾ Use this Conductor Category information for planning conductor routing. Refer to Industrial Automation Wiring and Grounding Guidelines, publication [1770-4.1](#).

⁽³⁾ If 24V DC is removed from the module, input resistance = 10 k Ω

Environmental

Attribute	Value
Operating temperature	IEC 60068-2-1 (Test Ad, Operating Cold), IEC 60068-2-2 (Test Bd, Operating Dry Heat), IEC 60068-2-14 (Test Nb, Operating Thermal Shock): -20...70 °C (-4...158 °F)
Non-operating temperature	IEC 60068-2-1 (Test Ab, Unpackaged Non-operating Cold), IEC 60068-2-2 (Test Bb, Unpackaged Non-operating Dry Heat), IEC 60068-2-14 (Test Na, Unpackaged Non-operating Thermal Shock): -40...85 °C (-40...185 °F)
Relative humidity	IEC 60068-2-30 (Test Db, Unpackaged Damp Heat): 5...95% noncondensing
Vibration	IEC 60068-2-6 (Test Fc, Operating): 5 g @ 10...500 Hz

Environmental

Operating shock	IEC 60068-2-27 (Test Ea, Unpackaged Shock): 30 g
Non-operating shock	IEC 60068-2-27 (Test Ea, Unpackaged Shock): 50 g
Emissions	CISPR 11: Group 1, Class A (with appropriate enclosure)
ESD immunity	IEC 61000-4-2: 6 kV contact discharges 8 kV air discharges
Radiated RF immunity	IEC 61000-4-3: 10V/m with 1 kHz sine-wave 80% AM from 80...2000 MHz 10V/m with 200 Hz 50% Pulse 100% AM at 900 MHz 10V/m with 200 Hz 50% Pulse 100% AM at 1890 MHz 3V/m with 1 kHz sine-wave 80% AM from 2000...2700 MHz
EFT/B immunity	IEC 61000-4-4: ±2 kV at 5 kHz on power ports ±2 kV at 5 kHz on signal ports
Surge transient immunity	IEC 61000-4-5: ±1 kV line-line(DM) and ±2 kV line-earth(CM) on power ports ±2 kV line-earth(CM) on shielded signal ports
Conducted RF immunity	IEC 61000-4-6: 10V rms with 1 kHz sine-wave 80% AM from 150 kHz...80 MHz

Certifications (when product is marked)⁽¹⁾

Attribute	Value
c-UL-us	UL Listed Industrial Control Equipment, certified for US and Canada. See UL File E65584. UL Listed for Class I, Division 2 Group A,B,C,D Hazardous Locations, certified for U.S. and Canada. See UL File E194810.
CE	European Union 2004/108/EC EMC Directive, compliant with: EN 61326-1; Meas./Control/Lab., Industrial Requirements EN 61000-6-2; Industrial Immunity EN 61000-6-4; Industrial Emissions EN 61131-2; Programmable Controllers (Clause 8, Zone A & B) European Union 2006/95/EC LVD, compliant with: EN 61131-2; Programmable Controllers (Clause 11)
C-Tick	Australian Radiocommunications Act, compliant with: AS/NZS CISPR 11; Industrial Emissions
Ex	European Union 94/9/EC ATEX Directive, compliant with: EN 60079-15; Potentially Explosive Atmospheres, Protection "n" EN 60079-0; General Requirements II 3 G Ex nA IIC T4 X
TÜV	TÜV Certified for Functional Safety: Capable of SIL 2

⁽¹⁾ See the Product Certification link at <http://www.ab.com> for Declaration of Conformity, Certificates, and other certification details.

Notes:

www.rockwellautomation.com

Power, Control and Information Solutions Headquarters

Americas: Rockwell Automation, 1201 South Second Street, Milwaukee, WI 53204-2496 USA, Tel: (1) 414.382.2000, Fax: (1) 414.382.4444

Europe/Middle East/Africa: Rockwell Automation, Vorstlaan/Boulevard du Souverain 36, 1170 Brussels, Belgium, Tel: (32) 2 663 0600, Fax: (32) 2 663 0640

Asia Pacific: Rockwell Automation, Level 14, Core F, Cyberport 3, 100 Cyberport Road, Hong Kong, Tel: (852) 2887 4788, Fax: (852) 2508 1846

Publication 1794-IN130A-EN-P - December 2009

Supersedes Publication 1794-IN129B-EN-P - April 2009

PN-65201

Copyright © 2009 Rockwell Automation, Inc. All rights reserved.