



## FactoryTalk Analytics LogixAI Module

Catalog Number 1756-CMS1B4

Topic	Page
Product Advisories	3
Required System Components	4
Module Overview	4
Remove the Battery Paper Tab	4
Install the Module	5
Connect to the Ethernet Port	5
Power the Module	5
Configure the Module	6
Create a Prediction Model	7
Reset the Module	10
Connect to the DisplayPort	10
Replace the Battery	10
Specifications	11
Additional Resources	11

The 1756-CMS1B4 FactoryTalk® Analytics™ LogixAI® module can communicate directly with a ControlLogix® 5570 or 5580 controller via the system backplane.

This module comes equipped with:

- FactoryTalk Analytics LogixAI software that you can use to access data and make informed decisions about the operation and maintenance of your system.
- One Ethernet port
- One USB 3.0 device port equipped with a dongle that provides software licensing. The dongle is required for the module to operate and must remain in the USB port
- An integrated DisplayPort for high definition monitor connectivity



**ATTENTION:** Read this document and the documents listed in the Additional Resources section about installation, configuration and operation of this equipment before you install, configure, operate or maintain this product. Users are required to familiarize themselves with installation and wiring instructions in addition to requirements of all applicable codes, laws, and standards.

Activities including installation, adjustments, putting into service, use, assembly, disassembly, and maintenance are required to be carried out by suitably trained personnel in accordance with applicable code of practice. If this equipment is used in a manner not specified by the manufacturer, the protection provided by the equipment may be impaired.

注意：在安装、配置、操作和维护本产品前，请阅读本文档以及“其他资源”部分列出的有关设备安装、配置和操作的相应文档。除了所有适用规范、法律和标准的相关要求之外，用户还必须熟悉安装和接线说明。

安装、调整、投运、使用、组装、拆卸和维护等各项操作必须由经过适当训练的专业人员按照适用的操作规范实施。

如果未按照制造商指定的方式使用该设备，则可能会损害设备提供的保护。

**ATENCIÓN:** Antes de instalar, configurar, poner en funcionamiento o realizar el mantenimiento de este producto, lea este documento y los documentos listados en la sección Recursos adicionales acerca de la instalación, configuración y operación de este equipo. Los usuarios deben familiarizarse con las instrucciones de instalación y cableado y con los requisitos de todos los códigos, leyes y estándares vigentes.

El personal debidamente capacitado debe realizar las actividades relacionadas a la instalación, ajustes, puesta en servicio, uso, ensamblaje, desensamblaje y mantenimiento de conformidad con el código de práctica aplicable. Si este equipo se usa de una manera no especificada por el fabricante, la protección provista por el equipo puede resultar afectada.

**ATENÇÃO:** Leia este e os demais documentos sobre instalação, configuração e operação do equipamento que estão na seção Recursos adicionais antes de instalar, configurar, operar ou manter este produto. Os usuários devem se familiarizar com as instruções de instalação e fiação além das especificações para todos os códigos, leis e normas aplicáveis.

É necessário que as atividades, incluindo instalação, ajustes, colocação em serviço, utilização, montagem, desmontagem e manutenção sejam realizadas por pessoal qualificado e especializado, de acordo com o código de prática aplicável.

Caso este equipamento seja utilizado de maneira não estabelecida pelo fabricante, a proteção fornecida pelo equipamento pode ficar prejudicada.

**ВНИМАНИЕ:** Перед тем как устанавливать, настраивать, эксплуатировать или обслуживать данное оборудование, прочитайте этот документ и документы, перечисленные в разделе «Дополнительные ресурсы». В этих документах изложены сведения об установке, настройке и эксплуатации данного оборудования. Пользователи обязаны ознакомиться с инструкциями по установке и прокладке соединений, а также с требованиями всех применимых норм, законов и стандартов. Все действия, включая установку, наладку, ввод в эксплуатацию, использование, сборку, разборку и техническое обслуживание, должны выполняться обученным персоналом в соответствии с применимыми нормами и правилами.

Если оборудование используется не предусмотренным производителем образом, защита оборудования может быть нарушена.

注意：本製品を設置、構成、稼働または保守する前に、本書および本機器の設置、設定、操作についての参考資料の該当箇所に記載されている文書を目を通してください。ユーザは、すべての該当する条例、法律、規格の要件に加えて、設置および配線の手順に習熟している必要があります。

設置調整、運転の開始、使用、組立て、解体、保守を含む諸作業は、該当する実施規則に従って訓練を受けた適切な作業員が実行する必要があります。

本機器が製造メーカーにより指定されていない方法で使用されている場合、機器により提供されている保護が損なわれる恐れがあります。

**ACHTUNG:** Lesen Sie dieses Dokument und die im Abschnitt „Weitere Informationen“ aufgeführten Dokumente, die Informationen zu Installation, Konfiguration und Bedienung dieses Produkts enthalten, bevor Sie dieses Produkt installieren, konfigurieren, bedienen oder warten. Anwender müssen sich neben den Bestimmungen aller anwendbaren Vorschriften, Gesetze und Normen zusätzlich mit den Installations- und Verdrahtungsanweisungen vertraut machen.

Arbeiten im Rahmen der Installation, Anpassung, Inbetriebnahme, Verwendung, Montage, Demontage oder Instandhaltung dürfen nur durch ausreichend geschulte Mitarbeiter und in Übereinstimmung mit den anwendbaren Ausführungsvorschriften vorgenommen werden.

Wenn das Gerät in einer Weise verwendet wird, die vom Hersteller nicht vorgesehen ist, kann die Schutzfunktion beeinträchtigt sein.

**ATTENTION :** Lisez ce document et les documents listés dans la section Ressources complémentaires relatifs à l'installation, la configuration et le fonctionnement de cet équipement avant d'installer, configurer, utiliser ou entretenir ce produit. Les utilisateurs doivent se familiariser avec les instructions d'installation et de câblage en plus des exigences relatives aux codes, lois et normes en vigueur.

Les activités relatives à l'installation, le réglage, la mise en service, l'utilisation, l'assemblage, le démontage et l'entretien doivent être réalisées par des personnes formées selon le code de pratique en vigueur.

Si cet équipement est utilisé d'une façon qui n'a pas été définie par le fabricant, la protection fournie par l'équipement peut être compromise.

주의：본 제품 설치, 설정, 작동 또는 유지 보수하기 전에 본 문서를 포함하여 설치, 설정 및 작동에 관한 참고 자료 섹션의 문서들을 반드시 읽고 숙지하십시오. 사용자는 모든 관련 규정, 법규 및 표준에서 요구하는 사항에 대해 반드시 설치 및 배선 지침을 숙지해야 합니다.

설치, 조정, 가동, 사용, 조립, 분해, 유지보수 등 모든 작업은 관련 규정에 따라 적절한 교육을 받은 사용자를 통해서만 수행해야 합니다.

본 장비를 제조사가 명시하지 않은 방법으로 사용하면 장비의 보호 기능이 손상될 수 있습니다.

**ATTENZIONE:** Prima di installare, configurare ed utilizzare il prodotto, o effettuare interventi di manutenzione su di esso, leggere il presente documento ed i documenti elencati nella sezione "Altre risorse", riguardanti l'installazione, la configurazione ed il funzionamento dell'apparecchiatura. Gli utenti devono leggere e comprendere le istruzioni di installazione e cablaggio, oltre ai requisiti previsti dalle leggi, codici e standard applicabili.

Le attività come installazione, regolazioni, utilizzo, assemblaggio, disassemblaggio e manutenzione devono essere svolte da personale adeguatamente addestrato, nel rispetto delle procedure previste.

Qualora l'apparecchio venga utilizzato con modalità diverse da quanto previsto dal produttore, la sua funzione di protezione potrebbe venire compromessa.

**DİKKAT:** Bu ürünün kurulumu, yapılandırılması, işletilmesi veya bakımı öncesinde bu dokümanı ve bu ekipmanın kurulumu, yapılandırılması ve işletimi ile ilgili ilave Kaynaklar bölümünde yer listelenmiş dokümanları okuyun. Kullanıcılar yürürlükteki tüm yönetmelikler, yasalar ve standartların gereksinimlerine ek olarak kurulum ve kablolama talimatlarını da öğrenmek zorundadır. Kurulum, ayarlama, hizmete alma, kullanma, parçaları birleştirme, parçaları sökme ve bakım gibi aktiviteler sadece uygun eğitimleri almış kişiler tarafından yürürlükteki uygulamaya yönetmeliklerine uygun şekilde yapılabilir.

Bu ekipman üretici tarafından belirlenmiş amacın dışında kullanılırsa, ekipman tarafından sağlanan koruma bozulabilir.

注意事項：在安装、設定、操作或維護本產品前，請先閱讀此文件以及列於「其他資源」章節中有關安裝、設定與操作此設備的文件。使用者必須熟悉安裝和配線指示，並符合所有法規、法律和標準要求。

包括安裝、調整、交付使用、使用、組裝、拆卸和維護等動作都必須交由已經過適當訓練的人員進行，以符合適用的實作法規。

如果將設備用於非製造商指定的用途時，可能會造成設備所提供的保護功能受損。

**POZOR:** Než začnete instalovat, konfigurovat či provozovat tento výrobek nebo provádět jeho údržbu, přečtěte si tento dokument a dokumenty uvedené v části Dodatečné zdroje ohledně instalace, konfigurace a provozu tohoto zařízení. Uživatelé se musejí vedle požadavků všech relevantních vyhlášek, zákonů a norem nutně seznámit také s pokyny pro instalaci a elektrické zapojení.

Činnosti zahrnující instalaci, nastavení, uvedení do provozu, užívání, montáž, demontáž a údržbu musí vykonávat vhodně proškolený personál v souladu s příslušnými prováděcími předpisy. Pokud se toto zařízení používá způsobem neodpovídajícím specifikaci výrobce, může být narušena ochrana, kterou toto zařízení poskytuje.

**UWAGA:** Przed instalacją, konfiguracją, użytkowaniem lub konserwacją tego produktu należy przeczytać niniejszy dokument oraz wszystkie dokumenty wymienione w sekcji Dodatkowe źródła omawiające instalację, konfigurację i procedury użytkowania tego urządzenia. Użytkownicy mają obowiązek zapoznać się z instrukcjami dotyczącymi instalacji oraz oprzewodowania, jak również z obowiązującymi kodeksami, prawem i normami.

Działania obejmujące instalację, regulację, przekazanie do użytkowania, użytkowanie, montaż, demontaż oraz konserwację muszą być wykonywane przez odpowiednio przeszkolony personel zgodnie z obowiązującym kodeksem postępowania.

Jeśli urządzenie jest użytkowane w sposób inny niż określony przez producenta, zabezpieczenie zapewniane przez urządzenie może zostać ograniczone.

**OB!** Läs detta dokument samt dokumentet, som står listat i avsnittet Övriga resurser, om installation, konfigurering och drift av denna utrustning innan du installerar, konfigurerar eller börjar använda eller utföra underhållsarbete på produkten. Användare måste bekanta sig med instruktioner för installation och kabeldragning, förutom krav enligt gällande koder, lagar och standarder.

Åtgärder som installation, justering, service, användning, montering, demontering och underhållsarbete måste utföras av personal med lämplig utbildning enligt lämpligt bruk.

Om denna utrustning används på ett sätt som inte anges av tillverkaren kan det hända att utrustningens skyddsanordningar försätts ur funktion.

**LET OP:** Lees dit document en de documenten die genoemd worden in de paragraaf Aanvullende informatie over de installatie, configuratie en bediening van deze apparatuur voordat u dit product installeert, configureert, bedient of onderhoudt. Gebruikers moeten zich vertrouwd maken met de installatie en de bedravingsinstructies, naast de vereisten van alle toepasselijke regels, wetten en normen.



Activiteiten zoals het installeren, afstellen, in gebruik stellen, gebruiken, monteren, demonteren en het uitvoeren van onderhoud mogen uitsluitend worden uitgevoerd door hiervoor opgeleide personeel en in overeenstemming met de geldende praktijkregels.

Indien de apparatuur wordt gebruikt op een wijze die niet is gespecificeerd door de fabrikant, dan bestaat het gevaar dat de beveiliging van de apparatuur niet goed werkt.

**IMPORTANT** Any illustrations, charts, sample programs, and layout examples that are shown in this publication are intended solely for the purposes of example. Since there are many variables and requirements that are associated with any particular installation, Rockwell Automation does not assume responsibility or liability for actual use that is based upon the examples that are shown in this publication.

## Product Advisories

### North American Hazardous Location Approval

The following information applies when operating this equipment in hazardous locations.	Informations sur l'utilisation de cet équipement en environnements dangereux.
<p>Products marked "CL I, DIV 2, GP A, B, C, D" are suitable for use in Class I Division 2 Groups A, B, C, D, Hazardous Locations and nonhazardous locations only. Each product is supplied with markings on the rating nameplate indicating the hazardous location temperature code. When combining products within a system, the most adverse temperature code (lowest "T" number) may be used to help determine the overall temperature code of the system. Combinations of equipment in your system are subject to investigation by the local Authority Having Jurisdiction at the time of installation.</p>	<p>Les produits marqués "CL I, DIV 2, GP A, B, C, D" ne conviennent qu'à une utilisation en environnements de Classe I Division 2 Groupes A, B, C, D dangereux et non dangereux. Chaque produit est livré avec des marquages sur sa plaque d'identification qui indiquent le code de température pour les environnements dangereux. Lorsque plusieurs produits sont combinés dans un système, le code de température le plus défavorable (code de température le plus faible) peut être utilisé pour déterminer le code de température global du système. Les combinaisons d'équipements dans le système sont sujettes à inspection par les autorités locales qualifiées au moment de l'installation.</p>
 <p><b>WARNING:</b> <b>Explosion Hazard -</b></p> <ul style="list-style-type: none"> <li>Do not disconnect equipment unless power has been removed or the area is known to be nonhazardous.</li> <li>Do not disconnect connections to this equipment unless power has been removed or the area is known to be nonhazardous. Secure any external connections that mate to this equipment by using screws, sliding latches, threaded connectors, or other means provided with this product.</li> <li>Substitution of components may impair suitability for Class I, Division 2.</li> <li>If this product contains batteries, they must only be changed in an area known to be nonhazardous.</li> </ul>	 <p><b>AVERTISSEMENT:</b> <b>Risque d'Explosion -</b></p> <ul style="list-style-type: none"> <li>Couper le courant ou s'assurer que l'environnement est classé non dangereux avant de débrancher l'équipement.</li> <li>Couper le courant ou s'assurer que l'environnement est classé non dangereux avant de débrancher les connecteurs. Fixer tous les connecteurs externes reliés à cet équipement à l'aide de vis, loquets coulissants, connecteurs filetés ou autres moyens fournis avec ce produit.</li> <li>La substitution de composants peut rendre cet équipement inadapté à une utilisation en environnement de Classe I, Division 2.</li> <li>S'assurer que l'environnement est classé non dangereux avant de changer les piles.</li> </ul>

### Environment and Enclosure

	<p><b>ATTENTION:</b> This equipment is intended for use in a Pollution Degree 2 industrial environment, in overvoltage Category II applications (as defined in EN/IEC 60664-1), at altitudes up to 2000 m (6562 ft) without derating. This equipment is not intended for use in residential environments and may not provide adequate protection to radio communication services in such environments.</p> <p>This equipment is supplied as open-type equipment for indoor use. It must be mounted within an enclosure that is suitably designed for those specific environmental conditions that will be present and appropriately designed to help prevent personal injury resulting from accessibility to live parts. The enclosure must have suitable flame-retardant properties to help prevent or minimize the spread of flame, complying with a flame spread rating of 5VA or be approved for the application if nonmetallic. The interior of the enclosure must be accessible only by the use of a tool. Subsequent sections of this publication may contain more information regarding specific enclosure type ratings that are required to comply with certain product safety certifications.</p> <p>In addition to this publication, see the following:</p> <ul style="list-style-type: none"> <li>Industrial Automation Wiring and Grounding Guidelines, publication <a href="#">1770-4.1</a>, for more installation requirements</li> <li>NEMA 250 and EN/IEC 60529, as applicable, for explanations of the degrees of protection provided by enclosures</li> </ul>
---	--

### Prevent Electrostatic Discharge

	<p><b>ATTENTION:</b> This equipment is sensitive to electrostatic discharge, which can cause internal damage and affect normal operation. Follow these guidelines when you handle this equipment:</p> <ul style="list-style-type: none"> <li>Touch a grounded object to discharge potential static.</li> <li>Wear an approved grounding wriststrap.</li> <li>Do not touch connectors or pins on component boards.</li> <li>Do not touch circuit components inside the equipment.</li> <li>Use a static-safe workstation, if available.</li> <li>Store the equipment in appropriate static-safe packaging when not in use.</li> </ul>
---	--

	<p><b>ATTENTION:</b></p> <ul style="list-style-type: none"> <li>Installation, adjustments, putting into service, use, assembly, disassembly, and maintenance are required to be carried out by suitably trained personnel in accordance with applicable code of practice.</li> <li>In case of malfunction or damage, no attempts at repair should be made. The module should be returned to the manufacturer for repair. Do not dismantle the module.</li> <li>When installed in a 1756 Series C Chassis, this equipment is certified for use only within the surrounding air temperature range of -25...+60 °C (-13...+140 °F). The equipment must not be used outside of this range. When installed in a 1756 Series B Chassis, this equipment is certified for use only within the surrounding air temperature range of -25...+50 °C (-13...+122 °F). The equipment must not be used outside of this range.</li> <li>Use only a soft dry anti-static cloth to wipe down equipment. Do not use any cleaning agents.</li> <li>USB and DisplayPort cables are not to exceed 3.0 m (9.84 ft).</li> </ul>
---	---

### Removal and Insertion Under Power (RIUP) Capability

	<p><b>WARNING:</b> When you insert or remove the module while backplane power is on, an electric arc can occur. This could cause an explosion in hazardous location installations. Be sure that power is removed or the area is nonhazardous before proceeding. Repeated electric arcing causes excessive wear to contacts on both the module and its mating connector. Worn contacts can create electrical resistance that can affect module operation.</p>
---	--

## Required System Components

To use the LogixAI® module, you need:

- a 1756 ControlLogix® controller installed in a chassis
- an RJ45 Ethernet cable

## Module Overview

### Product Dimensions

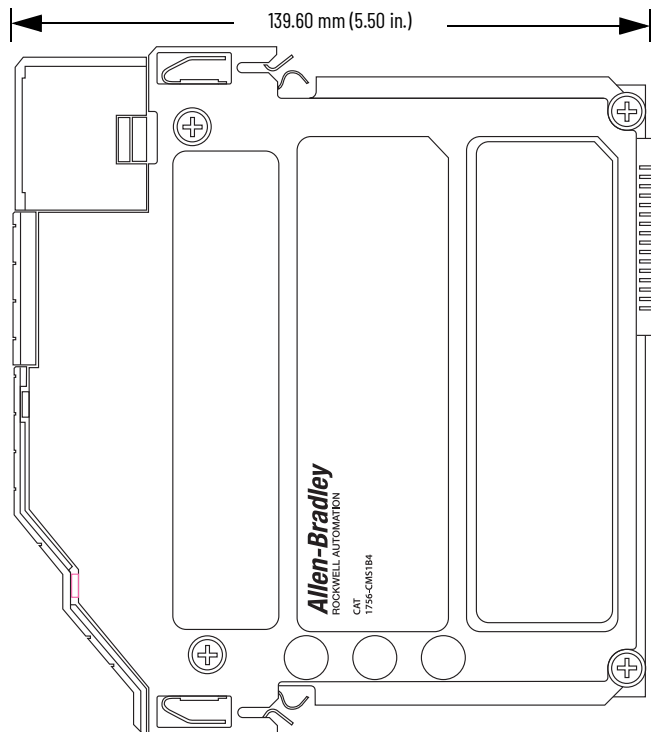
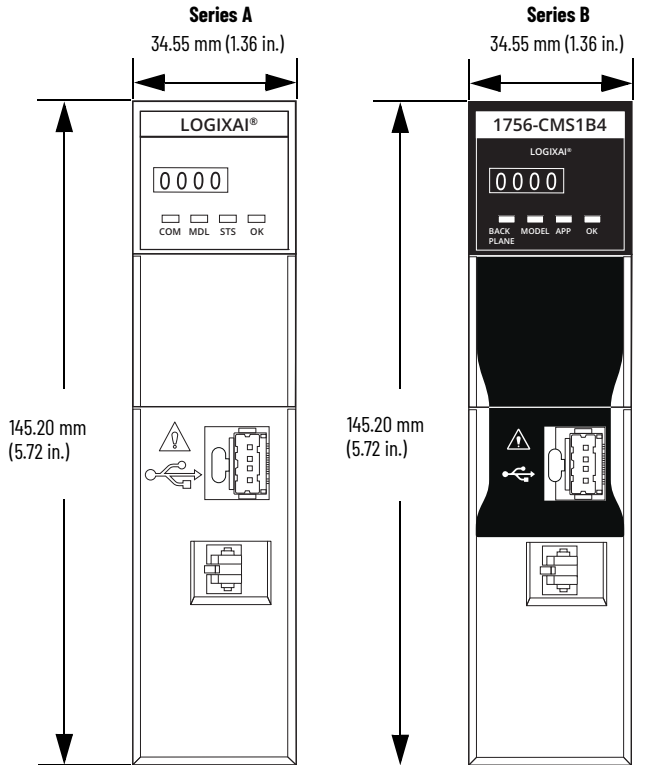

## Module Components

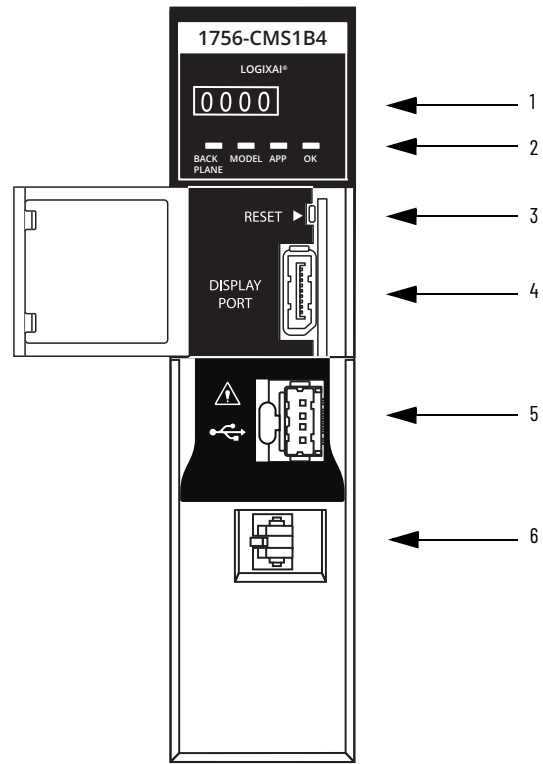

Number	Item	Description
1	Four-character display	Scrolls information about the module
2	Status indicators	Provides connection and module status information
3	Reset button	<ul style="list-style-type: none"> <li>• Used after module operation begins</li> <li>• Behind the module door</li> </ul>
4	DisplayPort connection	<ul style="list-style-type: none"> <li>• Connector to use a display with the module</li> <li>• Behind the module door</li> </ul>
5	USB 3.0 port	<ul style="list-style-type: none"> <li>• Equipped with a dongle containing software licensing</li> <li>• The dongle is required for the module to operate and must remain in the USB port or a USB hub that is connected to the USB port</li> </ul>
6	Ethernet port	Provides configuration connection to a computer

## Remove the Battery Paper Tab

The LogixAI module uses a battery to maintain the real-time clock on the module when it is without power. A battery is installed in the module when it ships.

A red paper tab covers the side of the battery that faces the backplane when the module is installed in a chassis.

Remove the paper tab before you install the module.

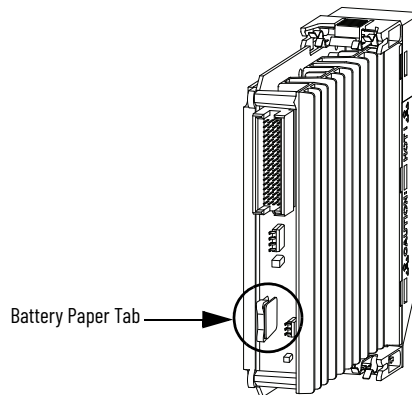

## Install the Module

You can install the module in any open slot in a ControlLogix chassis regardless of whether the chassis is local or remote to the controller location.



**WARNING:** When you insert or remove the module while backplane power is on, an electric arc can occur. This could cause an explosion in hazardous location installations. Be sure that power is removed or the area is nonhazardous before proceeding. Repeated electric arcing can cause excessive wear to contacts on both the module and its mating connector. Worn contacts can create electrical resistance that can affect module operation.

1. Align the circuit board with the top and bottom guides in the chassis.

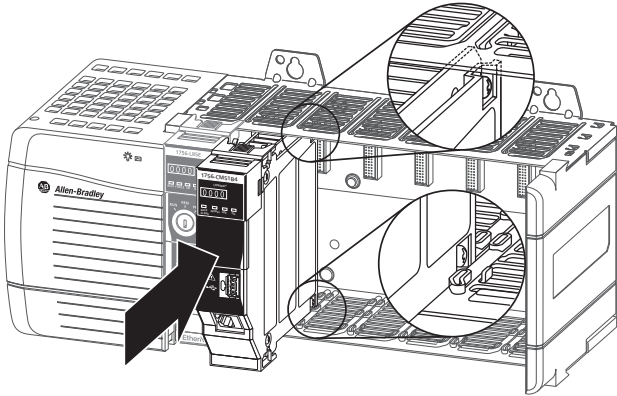

2. Slide the module into the chassis until it snaps into place.
3. Verify that the module is flush with the other installed devices.

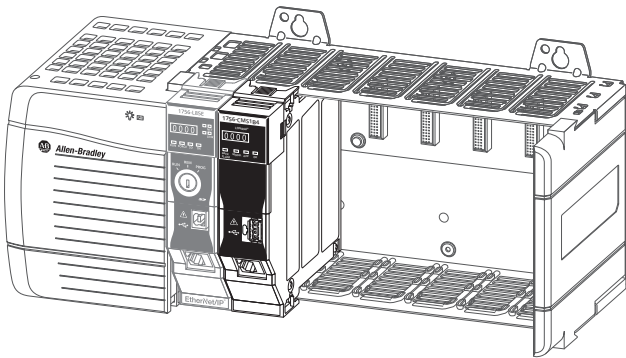

## Connect to the Ethernet Port



**WARNING:** If you connect or disconnect an Ethernet cable with power applied to this module or any device on the network, an electric arc can occur. This can cause an explosion in hazardous location installations. Be sure that power is removed or the area is nonhazardous before proceeding.

To connect the module to a computer or EtherNet/IP™ network, use an RJ45 cable and the embedded Ethernet port.

### Connect an Ethernet Cable to the LogixAI Module

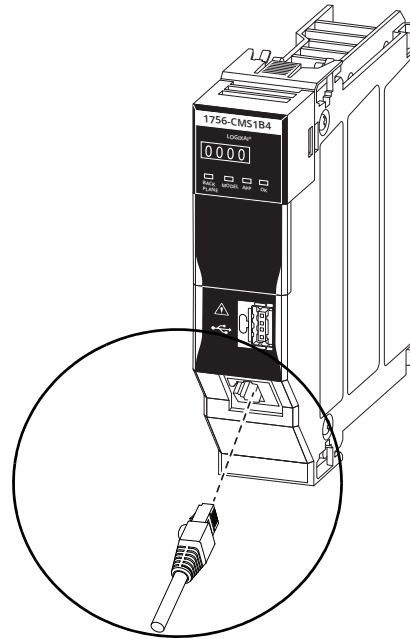

## Power the Module

After you install the module and make the necessary connections to it, supply power to the system.

The module performs a power-up sequence. The 4-character display and status indicators on the module indicate when the power-up sequence is complete.

## Configure the Module

To configure your module, complete these steps on the connected computer:

1. Change the IP address of the computer.
  - a. From the Microsoft Windows® Control Panel or System Tray, choose Network and Sharing Center > Change adapter settings.
  - b. Right-click the Local Area Connection that is connected to the appliance and select Properties.
  - c. Double-click the Internet Protocol Version 4 (TCP/IPv4) connection.



The default IP address of the module is 192.168.100.1.

- d. Set the IP address of the computer to be in the same range as the default IP address of the module.  
For example: 192.168.100.20 and the subnet mask to 255.255.255.0.

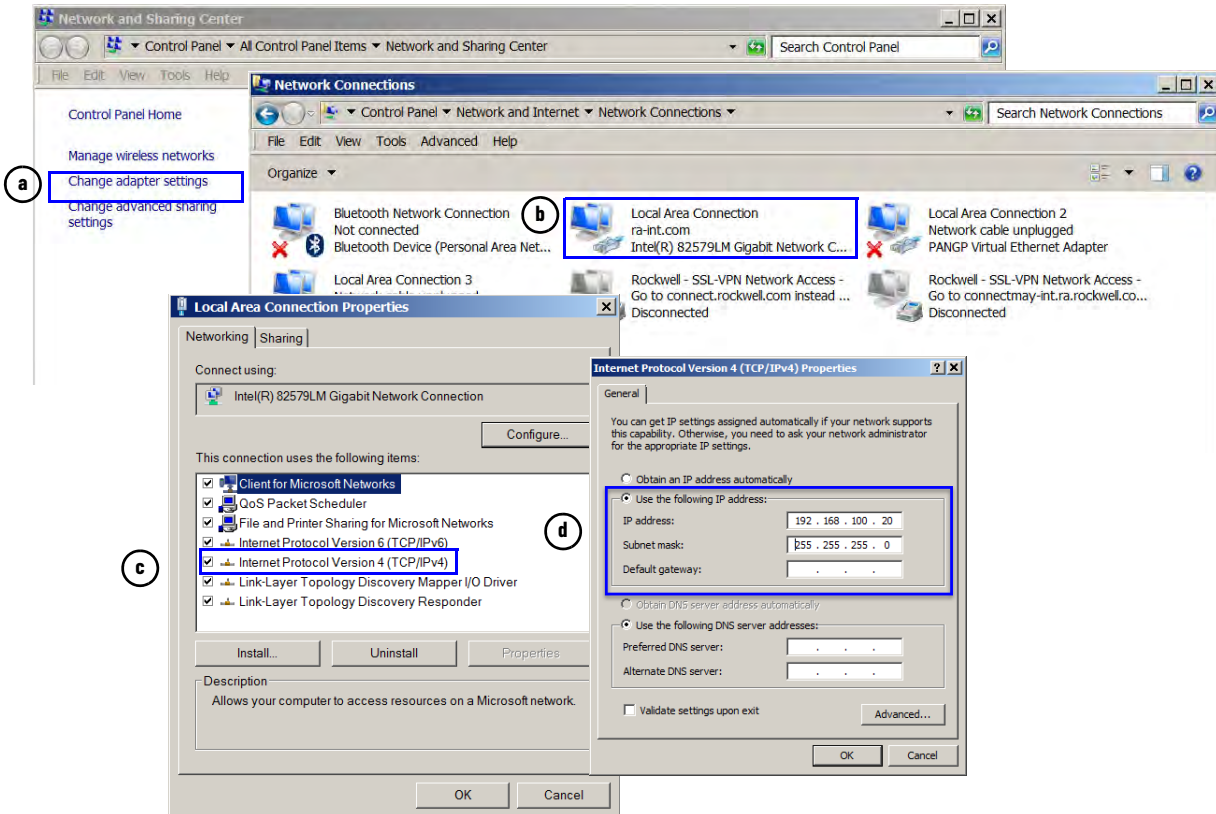

- e. To save the changes, select OK.
2. Open a web browser on the computer and go to <http://192.168.100.1>.



We recommend using Google Chrome.

The FactoryTalk Analytics LogixAI Get Started window appears.

3. Choose your language and select Get Started to follow the browser prompts and configure these module settings:

Setting	Description
Host Name	Define the network name of the module.
Date, Time, and Time Zone	Set the time stamp for the module to use.
Serial Number and Product Key	Enter information in both fields or neither. We <b>strongly recommend</b> that you enter the serial number and product key. Once entered, the information is stored on the onboard memory of the module. Future software updates require the serial number and product key. These updates are easier when the information is stored on the module rather than requiring you to reference the Activation Certificate and Envelope that comes with the module.
Network Options	Define network settings for the module.
Security	Define the administrator password.

4. View and accept the End User License Agreements (EULAs).
5. To complete the configuration, select Finish and Restart.
6. Return the IP address of your computer back to the original IP address.



## Create a Prediction Model

1. Access the module web services from a web browser at: `http://logixAIaddress/` where `logixAIaddress` = the IP address you entered in [step 3](#) of the module configuration process.



The configured module IP address also appears on the 4-character display of the module.

2. Select CREATE NEW.

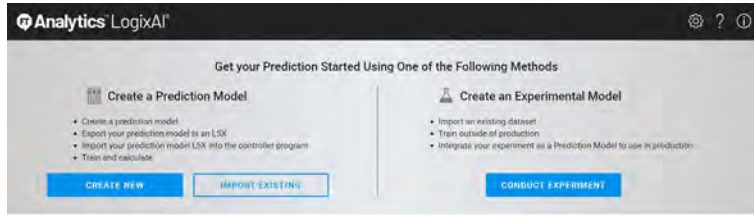

## Define Predictions

1. Select Create New Prediction.
  - a. Name the model (each model can have multiple predictions).
  - b. Make sure that the correct controller project is identified.
  - c. Select the Tag Method.
  - d. Select the Process Type.
  - e. Select the Prediction Type.
  - f. Name the prediction.

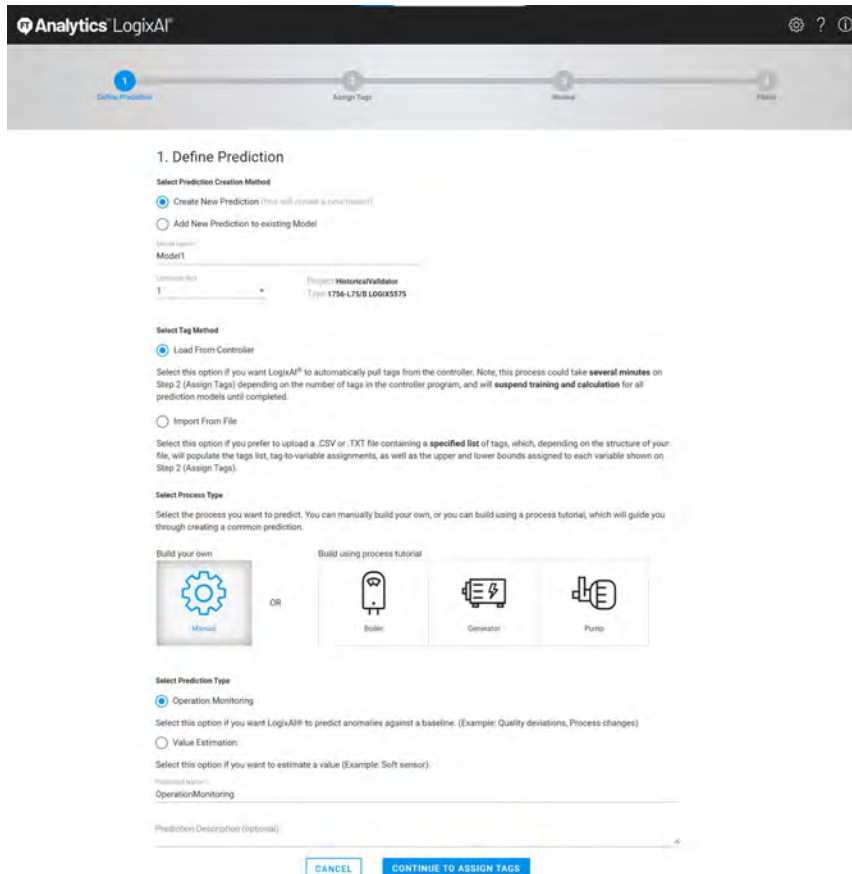

2. Select CONTINUE TO ASSIGN TAGS.

3. On the Assign Tags screen, select the controller tags and assign them to the following variables:
  - Variable of Interest
  - Input Variable(s)

  - a. Drag and drop tags from the left pane into the appropriate variable sections.
  - b. Enter the upper and lower bounds for each variable.

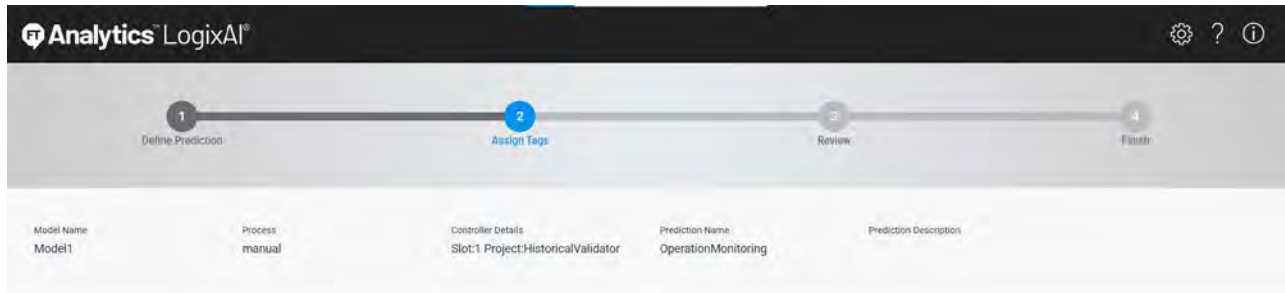

## 2. Assign Tags

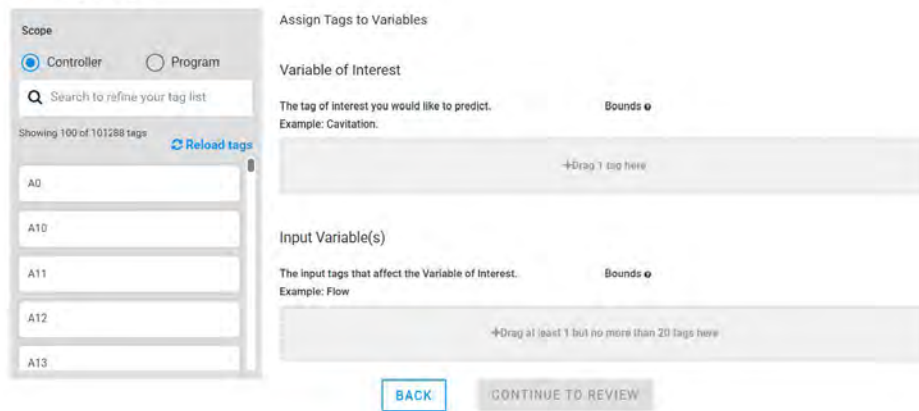

4. To review the tag assignments, select CONTINUE TO REVIEW.
5. Select FINISH.



## Train the Model

1. Save the model as a .L5X file.  
The .L5X file contains a user-defined data type (UDT) that you import into the controller project.

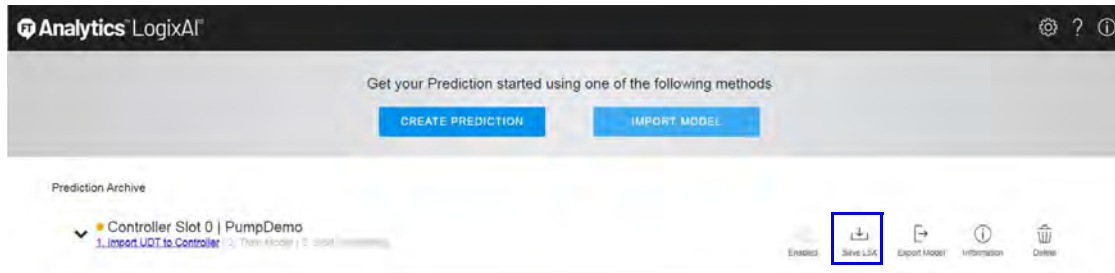

2. Open the controller project and import the UDT.  
You must have the programming software to edit the controller project.
3. Set the .TRAIN tag = 1.  
The tag is reset = 0 when training is complete.

• PumpDemo	{...}
▸ PumpDemo.Command	0
▸ PumpDemo.CommandCode	0
▸ PumpDemo.State	0
▸ PumpDemo.Calculate	0
▸ PumpDemo.Train	1
▸ PumpDemo.DataSampleSize	0
▸ PumpDemo.Reset	0
▸ PumpDemo.FaultCode	0
• PumpDemo.Calculations	{...}
▸ PumpDemo.Calculations.Success	0
PumpDemo.Calculations.ActualValue	0.0
PumpDemo.Calculations.PredictedValue	0.0
PumpDemo.Calculations.RelativeError	0.0
• PumpDemo.Training	{...}
PumpDemo.Training.Confidence	0.0
PumpDemo.Training.MeanAbsoluteError	0.0
• PumpDemo.AdditionalCommands	{...}
▸ PumpDemo.AdditionalCommands.ModelTraining	{...}
▸ PumpDemo.AdditionalCommands.ClearFaults	0

Complete training during normal system operation so that anomalous operation can be detected later.

4. Repeat setting the train tag as many times as needed, until the confidence in the results is sufficient.

## Start Calculations

Once training is complete, that is, when the .State tag = 2, start the analytic calculations.

1. Set the .Calculate tag = 1.
2. To determine appropriate system actions, monitor the results.

## Reset the Module

The LogixAI module has a reset button behind the door that functions like the power button on a computer. If you press and release the button, an orderly shutdown of the module occurs.

The button is not used during module installation.



**WARNING:** When you press the reset button while power is on, an electric arc can occur. This can cause an explosion in hazardous location installations. Be sure that power is removed or the area is nonhazardous before proceeding.

## Connect to the DisplayPort



**WARNING:** If you connect or disconnect the DisplayPort cable while power is applied to this module or any connected display devices, an electric arc can occur. This can cause an explosion in hazardous location installations. Be sure that power is removed or the area is nonhazardous before proceeding.

The DisplayPort interface lets you connect an industrial monitor to the LogixAI module. You can use the following industrial monitors with your LogixAI module:

- Super Video Graphics Array (SVGA) to HD 1080p
- High-Definition Multimedia Interface (HDMI)
- Video Graphics Array (VGA)
- Digital Visual Interface (DVI)
- DisplayPort

You must use a VESA-certified DisplayPort adapter to connect some industrial monitors to the module.



We recommend that you remove power from the module before connecting a monitor to the DisplayPort.

### Connect a Cable to the DisplayPort

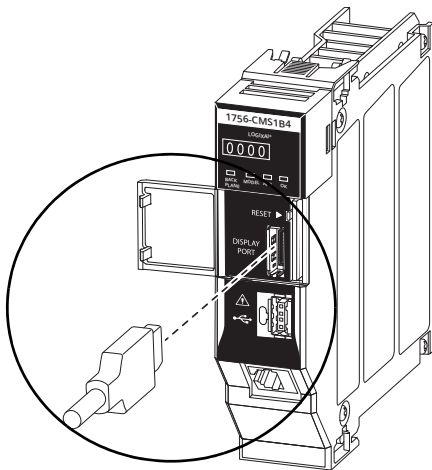

## Replace the Battery

LogixAI modules use a battery to maintain the real-time clock on the module when it is without power. A battery is installed in the module when it ships.



**WARNING:** When you connect or disconnect the battery an electric arc can occur. This can cause an explosion in hazardous location installations. Be sure that the area is nonhazardous before proceeding. For Safety information on the handling of lithium batteries, including the handling and disposal of leaking batteries, see [Guidelines for Handling Lithium Batteries](#), publication [AG 5-4](#).

You can replace the battery if necessary. The battery is a Panasonic Type BR1225A coin type lithium battery. Replacement batteries are commercially available.

To replace the battery, complete these steps.

1. Pull the white plastic battery holder from the back of the module.  
If necessary, pull the holder out far enough to use a small screwdriver to pry out the battery. In this case, insert the screwdriver from the side of the battery that faces the module printed circuit board.

**IMPORTANT** There are metal guides that hold the battery holder in place. Do not attempt to remove the guides.

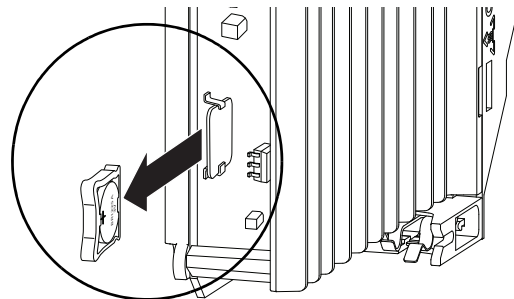

2. Remove the old battery from the holder.
3. Install a new battery into the holder.  
The side of the battery with words and numbers is installed in the side of the holder with tabs to hold it in place.

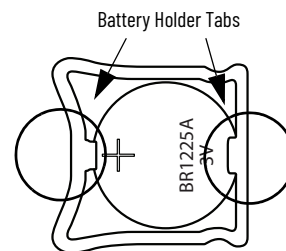

4. Reinstall the battery holder in the back of the module.  
The narrower part of the holder is installed first into the metal guides.

**IMPORTANT** Make sure that the battery is installed in an orientation so that the side of the battery with words and numbers faces away from the PCB.

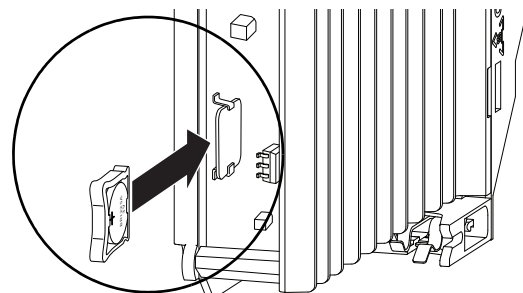

5. Push the battery holder all the way into the back of the module.

## Specifications

Attribute	1756-CMS1B4
Temperature, operating IEC 60068-2-1 (Test Ae, Operating Cold), IEC 60068-2-2 (Test Be, Operating Dry Heat), IEC 60068-2-14 (Test Nb, Operating Thermal Shock)	Series C Chassis: -25 °C < Ta < +60 °C (-13 °F < Ta < +140 °F) Series B Chassis: -25 °C < Ta < +50 °C (-13 °F < Ta < +122 °F)
Temperature, Surrounding Air, max	Series C Chassis: 60 °C (140 °F) Series B Chassis: 50 °C (122 °F)
Enclosure type rating	None (open-style)
Voltage and current ratings	5.1V DC @ 1.40 A
Wire size	Ethernet cabling and installation according to IEC 61918 and IEC 61784-5-2
Temperature Code	T5

## Additional Resources

These documents contain additional information concerning related products from Rockwell Automation.

Resource	Description
ControlLogix I/O Modules Specifications Technical Data, publication <a href="#">1756-TD002</a>	Provides specifications for ControlLogix I/O modules
Industrial Automation Wiring and Grounding Guidelines, publication <a href="#">1770-4.1</a>	Provides general guidelines for installing a Rockwell Automation industrial system
Product Certifications website, <a href="http://rok.auto/certifications">rok.auto/certifications</a>	Provides declarations of conformity, certificates, and other certification details

You can view or download publications at [rok.auto/literature](http://rok.auto/literature).

# Rockwell Automation Support

Use these resources to access support information.

<b>Technical Support Center</b>	Find help with how-to videos, FAQs, chat, user forums, Knowledgebase, and product notification updates.	<a href="http://rok.auto/support">rok.auto/support</a>
<b>Local Technical Support Phone Numbers</b>	Locate the telephone number for your country.	<a href="http://rok.auto/phonesupport">rok.auto/phonesupport</a>
<b>Technical Documentation Center</b>	Quickly access and download technical specifications, installation instructions, and user manuals.	<a href="http://rok.auto/techdocs">rok.auto/techdocs</a>
<b>Literature Library</b>	Find installation instructions, manuals, brochures, and technical data publications.	<a href="http://rok.auto/literature">rok.auto/literature</a>
<b>Product Compatibility and Download Center (PCDC)</b>	Download firmware, associated files (such as AOP, EDS, and DTM), and access product release notes.	<a href="http://rok.auto/pcdc">rok.auto/pcdc</a>

## Documentation Feedback

Your comments help us serve your documentation needs better. If you have any suggestions on how to improve our content, complete the form at [rok.auto/docfeedback](http://rok.auto/docfeedback).





## Waste Electrical and Electronic Equipment (WEEE)



At the end of life, this equipment should be collected separately from any unsorted municipal waste.

Rockwell Automation maintains current product environmental compliance information on its website at [rok.auto/pec](http://rok.auto/pec).

Rockwell Otomasyon Ticaret A.Ş. Kar Plaza İş Merkezi E Blok Kat:6 34752 İçerenköy, İstanbul, Tel: +90 (216) 5698400 EEE Yönetmeliğine Uygundur

Connect with us.    

[rockwellautomation.com](http://rockwellautomation.com)

expanding **human possibility**<sup>®</sup>

AMERICAS: Rockwell Automation, 1201 South Second Street, Milwaukee, WI 53204-2496 USA, Tel: (1) 414.382.2000, Fax: (1) 414.382.4444

EUROPE/MIDDLE EAST/AFRICA: Rockwell Automation NV, Pegasus Park, De Kleetlaan 12a, 1831 Diegem, Belgium, Tel: (32) 2 663 0600, Fax: (32) 2 663 0640

ASIA PACIFIC: Rockwell Automation, Level 14, Core F, Cyberport 3, 100 Cyberport Road, Hong Kong, Tel: (852) 2887 4788, Fax: (852) 2508 1846

UNITED KINGDOM: Rockwell Automation Ltd, Pitfield, Kiln Farm Milton Keynes, MK11 3DR, United Kingdom, Tel: (44)(1908) 838-800, Fax: (44)(1908) 261-917

Allen-Bradley, ControlLogix, expanding human possibility, FactoryTalk Analytics LogixAI, LogixAI, and Rockwell Automation are trademarks of Rockwell Automation, Inc.

EtherNet/IP is a trademark of ODVA, Inc.

Microsoft Windows is a trademark of Microsoft Corporation.

Trademarks not belonging to Rockwell Automation are property of their respective companies.

Publication 1756-IN093A-EN-P - June 2023

Copyright © 2023 Rockwell Automation, Inc. All rights reserved. Printed in the U.S.A.

PN-687504