

ControlLogix AC Digital I/O Modules

Catalog Numbers 1756-IA8D, 1756-IA8DK, 1756-IA16, 1756-IA16K, 1756-IA16I, 1756-IA16IK, 1756-IA32, 1756-IA32K, 1756-IM16I, 1756-IM16IK, 1756-IN16, 1756-IN16K, 1756-OA8D, 1756-OA8, 1756-OA8K, 1756-OA8E, 1756-OA8EK, 1756-OA16, 1756-OA16K, 1756-OA16I, 1756-OA16IK, 1756-ON8, 1756-ON8K

Topic	Page
Installation Requirements	5
Install the Module	5
Key the Removable Terminal Block	5
Connect Wiring	5
Assemble the RTB and the Housing	6
Install the Removable Terminal Block	6
Specifications	7
Additional Resources	10

ControlLogix® digital I/O modules are input and output modules that provide On/Off detection and actuation. By using the producer/consumer network model, digital I/O modules can produce information when needed while providing additional system functions.

The catalog numbers of the conformal coated products include the designation ‘K’ in the last position before the series identifier.

Summary of Changes

Topic	Page
Added 1756-IA8DK, 1756-IN16K, 1756-OA8K, 1756-OA8EK, and 1756-ON8K modules	Throughout
Added ATEX Temp Code and certificate number for the 1756-ON8 and 1756-ON8K modules	8
Added specifications for the 1756-OA16 and 1756-OA16K modules	9



ATTENTION: Read this document and the documents listed in the [Additional Resources](#) section about installation, configuration, and operation of this equipment before you install, configure, operate, or maintain this product. Users are required to familiarize themselves with installation and wiring instructions in addition to requirements of all applicable codes, laws, and standards.

Installation, adjustments, putting into service, use, assembly, disassembly, and maintenance are required to be carried out by suitably trained personnel in accordance with applicable code of practice.

Any illustrations, charts, sample programs, and layout examples that are shown in this publication are intended solely for the purposes of example. Since there are many variables and requirements associated with any particular installation, Rockwell Automation does not assume responsibility or liability for actual use based on the examples shown in this publication.

If this equipment is used in a manner not specified by the manufacturer, the protection provided by the equipment may be impaired.



ATTENTION: Read this document and the documents listed in the Additional Resources section about installation, configuration and operation of this equipment before you install, configure, operate or maintain this product. Users are required to familiarize themselves with installation and wiring instructions in addition to requirements of all applicable codes, laws, and standards.

Activities including installation, adjustments, putting into service, use, assembly, disassembly, and maintenance are required to be carried out by suitably trained personnel in accordance with applicable code of practice.

If this equipment is used in a manner not specified by the manufacturer, the protection provided by the equipment may be impaired.

注意: 在安装、配置、操作和维护本产品前, 请阅读本文档以及“其他资源”部分列出的有关设备安装、配置和操作的相应文档。除了所有适用规范、法律和标准的相关要求之外, 用户还必须熟悉安装和接线说明。

安装、调整、投运、使用、组装、拆卸和维护等各项操作必须由经过适当训练的专业人员按照适用的操作规范实施。

如果未按照制造商指定的方式使用该设备, 则可能会损害设备提供的保护。

ATENCIÓN: Antes de instalar, configurar, poner en funcionamiento o realizar el mantenimiento de este producto, lea este documento y los documentos listados en la sección Recursos adicionales acerca de la instalación, configuración y operación de este equipo. Los usuarios deben familiarizarse con las instrucciones de instalación y cableado y con los requisitos de todos los códigos, leyes y estándares vigentes.

El personal debidamente capacitado debe realizar las actividades relacionadas a la instalación, ajustes, puesta en servicio, uso, ensamblaje, desensamblaje y mantenimiento de conformidad con el código de práctica aplicable.

Si este equipo se usa de una manera no especificada por el fabricante, la protección provista por el equipo puede resultar afectada.

ATENÇÃO: Leia este e os demais documentos sobre instalação, configuração e operação do equipamento que estão na seção Recursos adicionais antes de instalar, configurar, operar ou manter este produto. Os usuários devem se familiarizar com as instruções de instalação e fiação além das especificações para todos os códigos, leis e normas aplicáveis.

É necessário que as atividades, incluindo instalação, ajustes, colocação em serviço, utilização, montagem, desmontagem e manutenção sejam realizadas por pessoal qualificado e especializado, de acordo com o código de prática aplicável.

Caso este equipamento seja utilizado de maneira não estabelecida pelo fabricante, a proteção fornecida pelo equipamento pode ficar prejudicada.

ВНИМАНИЕ: Перед тем как устанавливать, настраивать, эксплуатировать или обслуживать данное оборудование, прочитайте этот документ и документы, перечисленные в разделе «Дополнительные ресурсы». В этих документах изложены сведения об установке, настройке и эксплуатации данного оборудования. Пользователи обязаны ознакомиться с инструкциями по установке и прокладке соединений, а также с требованиями всех применимых норм, законов и стандартов.

Все действия, включая установку, наладку, ввод в эксплуатацию, использование, сборку, разборку и техническое обслуживание, должны выполняться обученным персоналом в соответствии с применимыми нормами и правилами.

Если оборудование используется не предусмотренным производителем образом, защита оборудования может быть нарушена.

注意: 本製品を設置、構成、稼動または保守する前に、本書および本機器の設置、設定、操作についての参考資料の該当箇所に記載されている文書に目を通してください。ユーザは、すべての該当する条例、法律、規格の要件に加えて、設置および配線の手順に習熟している必要があります。

設置調整、運転の開始、使用、組立て、解体、保守を含む諸作業は、該当する実施規則に従って訓練を受けた適切な作業員が実行する必要があります。

本機器が製造メーカーにより指定されていない方法で使用されている場合、機器により提供されている保護が損なわれる恐れがあります。

ACHTUNG: Lesen Sie dieses Dokument und die im Abschnitt „Weitere Informationen“ aufgeführten Dokumente, die Informationen zu Installation, Konfiguration und Bedienung dieses Produkts enthalten, bevor Sie dieses Produkt installieren, konfigurieren, bedienen oder warten. Anwender müssen sich neben den Bestimmungen aller anwendbaren Vorschriften, Gesetze und Normen zusätzlich mit den Installations- und Verdrahtungsanweisungen vertraut machen.

Arbeiten im Rahmen der Installation, Anpassung, Inbetriebnahme, Verwendung, Montage, Demontage oder Instandhaltung dürfen nur durch ausreichend geschulte Mitarbeiter und in Übereinstimmung mit den anwendbaren Ausführungsvorschriften vorgenommen werden.

Wenn das Gerät in einer Weise verwendet wird, die vom Hersteller nicht vorgesehen ist, kann die Schutzfunktion beeinträchtigt sein.

ATTENTION : Lisez ce document et les documents listés dans la section Ressources complémentaires relatifs à l'installation, la configuration et le fonctionnement de cet équipement avant d'installer, configurer, utiliser ou entretenir ce produit. Les utilisateurs doivent se familiariser avec les instructions d'installation et de câblage en plus des exigences relatives aux codes, lois et normes en vigueur.

Les activités relatives à l'installation, le réglage, la mise en service, l'utilisation, l'assemblage, le démontage et l'entretien doivent être réalisées par des personnes formées selon le code de pratique en vigueur.

Si cet équipement est utilisé d'une façon qui n'a pas été définie par le fabricant, la protection fournie par l'équipement peut être compromise.

주의: 본 제품 설치, 설정, 작동 또는 유지 보수하기 전에 본 문서를 포함하여 설치, 설정 및 작동에 관한 참고 자료 섹션의 문서들을 반드시 읽고 숙지하십시오. 사용자는 모든 관련 규정, 법규 및 표준에서 요구하는 사항에 대해 반드시 설치 및 배선 지침을 숙지해야 합니다.

설치, 조정, 가동, 사용, 조립, 분해, 유지보수 등 모든 작업은 관련 규정에 따라 적절한 교육을 받은 사용자를 통해서만 수행해야 합니다.

본 장비를 제조사가 명시하지 않은 방법으로 사용하면 장비의 보호 기능이 손상될 수 있습니다.

ATTENZIONE Prima di installare, configurare ed utilizzare il prodotto, o effettuare interventi di manutenzione su di esso, leggere il presente documento ed i documenti elencati nella sezione "Altre risorse", riguardanti l'installazione, la configurazione ed il funzionamento dell'apparecchiatura. Gli utenti devono leggere e comprendere le istruzioni di installazione e cablaggio, oltre ai requisiti previsti dalle leggi, codici e standard applicabili.

Le attività come installazione, regolazioni, utilizzo, assemblaggio, disassemblaggio e manutenzione devono essere svolte da personale adeguatamente addestrato, nel rispetto delle procedure previste.

Qualora l'apparecchio venga utilizzato con modalità diverse da quanto previsto dal produttore, la sua funzione di protezione potrebbe venire compromessa.

DIKKAT: Bu ürünün kurulumu, yapılandırılması, işletilmesi veya bakımı öncesinde bu dokümanı ve bu ekipmanın kurulumu, yapılandırılması ve işletimi ile ilgili ilave Kaynaklar bölümünde yer listelenmiş dokümanları okuyun. Kullanıcılar yürürlükteki tüm yönetmelikler, yasalar ve standartların gereksinimlerine ek olarak kurulum ve kablolama talimatlarını da öğrenmek zorundadır.

Kurulum, ayarlama, hizmet alma, kulanma, parçaları birleştirme, parçaları sökme ve bakım gibi aktiviteler sadece uygun eğitimleri almış kişiler tarafından yürürlükteki uygulama yönetmeliklerine uygun şekilde yapılabilir.

Bu ekipman üretici tarafından belirlenmiş amacın dışında kullanılırsa, ekipman tarafından sağlanan koruma bozulabilir.

注意事項: 在安装、設定、操作或維護本產品前, 請先閱讀此文件以及列於「其他資源」章節中有關安裝、設定與操作此設備的文件。使用者必須熟悉安裝和配線指示, 並符合所有法規、法律和標準要求。

包括安裝、調整、交付使用、使用、組裝、拆卸和維護等動作都必須交由已經過適當訓練的人員進行, 以符合適用的實作法規。

如果將設備用於非製造商指定的用途時, 可能會造成設備所提供的保護功能受損。

POZOR: Než začnete instalovat, konfigurovat či provozovat tento výrobek nebo provádět jeho údržbu, přečtěte si tento dokument a dokumenty uvedené v části Dodatečné zdroje ohledně instalace, konfigurace a provozu tohoto zařízení. Uživatelé se musejí vedle požadavků všech relevantních vyhlášek, zákonů a norem nutně seznámit také s pokyny pro instalaci elektrické zapojení.

Činnosti zahrnující instalaci, nastavení, uvedení do provozu, užívání, montáž, demontáž a údržbu musí vykonávat vhodně proškolený personál v souladu s příslušnými prováděcími předpisy.

Pokud se toto zařízení používá způsobem neodpovídajícím specifikaci výrobce, může být narušena ochrana, kterou toto zařízení poskytuje.

UWAGA: Przed instalacją, konfiguracją, użytkowaniem lub konserwacją tego produktu należy przeczytać niniejszy dokument oraz wszystkie dokumenty wymienione w sekcji Dodatkowe źródła omawiające instalację, konfigurację i procedury użytkowania tego urządzenia. Użytkownicy mają obowiązek zapoznać się z instrukcjami dotyczącymi instalacji oraz oprzewodowania, jak również z obowiązującymi kodeksami, prawem i normami.

Działania obejmujące instalację, regulację, przekazanie do użytkowania, użytkowanie, montaż, demontaż oraz konserwację muszą być wykonywane przez odpowiednio przeszkolony personel zgodnie z obowiązującym kodeksem postępowania.

Jeśli urządzenie jest użytkowane w sposób inny niż określony przez producenta, zabezpieczenie zapewniane przez urządzenie może zostać ograniczone.

BSI Las detta dokument samt dokumentet, som står listat i avsnittet Övriga resurser, om installation, konfigurering och drift av denna utrustning innan du installerar, konfigurerar eller börjar använda eller utföra underhållsarbete på produkten. Användare måste bekanta sig med instruktioner för installation och kabeldragning, förutom krav enligt gällande koder, lagar och standarder.

Åtgärder som installation, justering, service, användning, montering, demontering och underhållsarbete måste utföras av personal med lämplig utbildning enligt lämpligt bruk.

Om denna utrustning används på ett sätt som inte anges av tillverkaren kan det hända att utrustningens skyddsanordningar försätts ur funktion.

LET OP: Lees dit document en de documenten die genoemd worden in de paragraaf Aanvullende informatie over de installatie, configuratie en bediening van deze apparatuur voordat u dit product installeert, configureert, bediend of onderhoudt. Gebruikers moeten zich vertrouwd maken met de installatie en de bedradinginstructies, naast de vereisten van alle toepasselijke regels, wetten en normen.

Activiteiten zoals het installeren, afstellen, in gebruik stellen, gebruiken, monteren, demonteren en het uitvoeren van onderhoud mogen uitsluitend worden uitgevoerd door hiervoor opgeleid personeel en in overeenstemming met de geldende praktijkregels.

Indien de apparatuur wordt gebruikt op een wijze die niet is gespecificeerd door de fabrikant, dan bestaat het gevaar dat de beveiliging van de apparatuur niet goed werkt.



ATTENTION: This equipment is certified for use only within the surrounding air temperature range of 0...60 °C (32...140 °F). The equipment must not be used outside of this range.

In case of malfunction or damage, make no attempt at repair. Return the module to the manufacturer for repair. Do not dismantle the module.

Use only a soft dry anti-static cloth to wipe down equipment. Do not use any cleaning agents.

Environment and Enclosure



ATTENTION: This equipment is intended for use in a Pollution Degree 2 industrial environment, in overvoltage Category II applications (as defined in EN/IEC 60664-1), at altitudes up to 2000 m (6562 ft) without derating.

This equipment is considered Group 1, Class A industrial equipment according to IEC/CISPR 11. Without appropriate precautions, there may be difficulties with electromagnetic compatibility in residential and other environments due to conducted and radiated disturbances.

This equipment is supplied as open-type equipment. It must be mounted within an enclosure that is suitably designed for those specific environmental conditions that will be present and appropriately designed to help prevent personal injury resulting from accessibility to live parts. The enclosure must have suitable flame-retardant properties to help prevent or minimize the spread of flame, complying with a flame spread rating of 5VA, V2, V1, V0 (or equivalent) if non-metallic. The interior of the enclosure must be accessible only by the use of a tool. Subsequent sections of this publication may contain additional information regarding specific enclosure type ratings that are required to comply with certain product safety certifications.

In addition to this publication, see the following:

- Industrial Automation Wiring and Grounding Guidelines, publication [1770-4.1](#), for additional installation requirements.
- NEMA Standard 250 and EN/IEC 60529, as applicable, for explanations of the degrees of protection provided by different types of enclosure.

Prevent Electrostatic Discharge



ATTENTION: This equipment is sensitive to electrostatic discharge, which can cause internal damage and affect normal operation. Follow these guidelines when you handle this equipment:

- Touch a grounded object to discharge potential static.
- Wear an approved grounding wriststrap.
- Do not touch connectors or pins on component boards.
- Do not touch circuit components inside the equipment.
- Use a static-safe workstation, if available.
- Store the equipment in appropriate static-safe packaging when not in use.

Removal and Insertion Under Power (RIUP)



WARNING: When you insert or remove the module while backplane power is on, an electric arc can occur. This could cause an **explosion** in hazardous location installations.

Be sure that power is removed or the area is nonhazardous before proceeding. Repeated electric arcing causes excessive wear to contacts on both the module and its mating connector. Worn contacts can create electrical resistance that can affect module operation.

Removable Terminal Blocks (RTB)



WARNING: When you connect or disconnect the removable terminal block (RTB) with field-side power applied, an electric arc can occur. This could cause an **explosion** in hazardous location installations.

Be sure that power is removed or the area is nonhazardous before proceeding.

Waste Electrical and Electronic Equipment (WEEE)



At the end of its life, this equipment should be collected separately from any unsorted municipal waste.

Electrical Safety Considerations





ATTENTION: Wire conductor and insulation ratings shall support minimum temperature rating of 105 °C (221 °F).

If multiple power sources are used, do not exceed the specified isolation voltage.

When using the 1756-TBNH, do not wire more than two 0.33...1.3 mm² (22...16 AWG) conductors on any terminal. Use only the same size wires with no intermixing of solid and stranded wire types.

When using the 1756-TBSH, do not wire more than one 0.33...2.1mm² (22...14 AWG) conductor on any terminal.

North American Hazardous Location Approval

The following information applies when operating this equipment in hazardous locations.	Informations sur l'utilisation de cet équipement en environnements dangereux.
<p>Products marked "CL I, DIV 2, GP A, B, C, D" are suitable for use in Class I Division 2 Groups A, B, C, D, Hazardous Locations and nonhazardous locations only. Each product is supplied with markings on the rating nameplate indicating the hazardous location temperature code. When combining products within a system, the most adverse temperature code (lowest "T" number) may be used to help determine the overall temperature code of the system. Combinations of equipment in your system are subject to investigation by the local Authority Having Jurisdiction at the time of installation.</p>	<p>Les produits marqués "CL I, DIV 2, GP A, B, C, D" ne conviennent qu'à une utilisation en environnements de Classe I Division 2 Groupes A, B, C, D dangereux et non dangereux. Chaque produit est livré avec des marquages sur sa plaque d'identification qui indiquent le code de température pour les environnements dangereux. Lorsque plusieurs produits sont combinés dans un système, le code de température le plus défavorable (code de température le plus faible) peut être utilisé pour déterminer le code de température global du système. Les combinaisons d'équipements dans le système sont sujettes à inspection par les autorités locales qualifiées au moment de l'installation.</p>
 <p>WARNING: Explosion Hazard –</p> <ul style="list-style-type: none"> Do not disconnect equipment unless power has been removed or the area is known to be nonhazardous. Do not disconnect connections to this equipment unless power has been removed or the area is known to be nonhazardous. Secure any external connections that mate to this equipment by using screws, sliding latches, threaded connectors, or other means provided with this product. Substitution of components may impair suitability for Class I, Division 2. If this product contains batteries, they must only be changed in an area known to be nonhazardous. 	 <p>AVERTISSEMENT: Risque d'Explosion –</p> <ul style="list-style-type: none"> Couper le courant ou s'assurer que l'environnement est classé non dangereux avant de débrancher l'équipement. Couper le courant ou s'assurer que l'environnement est classé non dangereux avant de débrancher les connecteurs. Fixer tous les connecteurs externes reliés à cet équipement à l'aide de vis, loquets coulissants, connecteurs filetés ou autres moyens fournis avec ce produit. La substitution de composants peut rendre cet équipement inadapté à une utilisation en environnement de Classe I, Division 2. S'assurer que l'environnement est classé non dangereux avant de changer les piles.

European Hazardous Location Approval

The following applies to products marked CE Ex II 3 G:

- Are Equipment Group II, Equipment Category 3, and comply with the Essential Health and Safety Requirements relating to the design and construction of such equipment given in Annex II to EU Directive 2014/34/EU. See the EU Declaration of Conformity at <http://www.rockwellautomation.com/global/certification/overview.page> for details.
- 1756-ON8: The type of protection is "Ex nA IIC T4 Gc" according to EN 60079-15.
- 1756-IN16: The type of protection is "Ex nA IIC T3 Gc" according to EN 60079-15.
- Comply to Standards EN 60079-0:2012+A11:2013 EN 60079-15:2010, reference certificate number DEMKO 16 ATEX 1792X Rev. 2
- Are intended for use in areas in which explosive atmospheres caused by gases, vapors, mists, or air are unlikely to occur, or are likely to occur only infrequently and for short periods. Such locations correspond to Zone 2 classification according to ATEX directive 2014/34/EU
- May have catalog numbers followed by a "K" to indicate a conformal coating option.

IEC Hazardous Location Approval

The following applies to products with IECEx certification:

- Such modules are intended for use in areas in which explosive atmospheres caused by gases, vapors, mists, or air are unlikely to occur, or are likely to occur only infrequently and for short periods. Such locations correspond to Zone 2 classification to IEC 60079-0.
- The type of protection for catalog numbers 1756-IN16 is "Ex nA IIC T3 Gc" according to IEC-60079-15.
- The type of protection for catalog numbers 1756-ON8 is "Ex nA IIC T4 Gc" according to IEC-60079-15.
- Such modules as catalog numbers as 1756-IN16 and 1756-ON8 comply to standards IEC 60079-0 : 2011, IEC 60079-15 : 2010, reference IECEx certificate number IECEx UL 16.0151X.
- May have catalog numbers followed by a "K" to indicate a conformal coating option.

Special Conditions for Safe Use



WARNING:

- This equipment is not resistant to sunlight or other sources of UV radiation
- This equipment shall be mounted in an ATEX/IECEx Zone 2 certified enclosure with a minimum ingress protection rating of at least IP54 (in accordance with EN/IEC 60079-15) and used in an environment of not more than Pollution Degree 2 (as defined in EN/IEC 60664-1) when applied in Zone 2 environments. The enclosure must be accessible only by the use of a tool.
- This equipment shall be used within its specified ratings defined by Rockwell Automation.
- Secure any external connections that mate to this equipment by using screws, sliding latches, threaded connectors, or other means provided with this product.
- Do not disconnect equipment unless power has been removed or the area is known to be nonhazardous.
- Provision shall be made to help prevent the rated voltage from being exceeded by transient disturbances of more than 140% of the peak rated voltage when applied in Zone 2 environments.
- This equipment must be used only with ATEX/IECEx certified Rockwell Automation backplanes.
- The instructions in the user manual shall be observed.

Installation Requirements

Before you install the module, you must complete these steps.

1. Install a 1756 ControlLogix chassis.
2. Install a 1756 ControlLogix power supply.

Installation instructions can be found in the ControlLogix Digital I/O Modules User Manual, publication [1756-UM058](#).

Install the Module

You can install or remove a module while chassis power is applied.



ATTENTION: The module is designed to support removal and insertion under power (RIUP). However, when you remove or insert a removable terminal block (RTB) with field-side power applied, unintended machine motion or loss of process control can occur. Exercise extreme caution when using this feature. We recommend that you remove field-side power before installing the RTB onto the module.



SHOCK HAZARD: If the RTB is installed onto the module while the field-side power is applied, the RTB is electrically live. Do not touch the RTB terminals. Failure to observe this caution can result in personal injury.

Slide the module into the slot in the chassis until the locking tabs click.

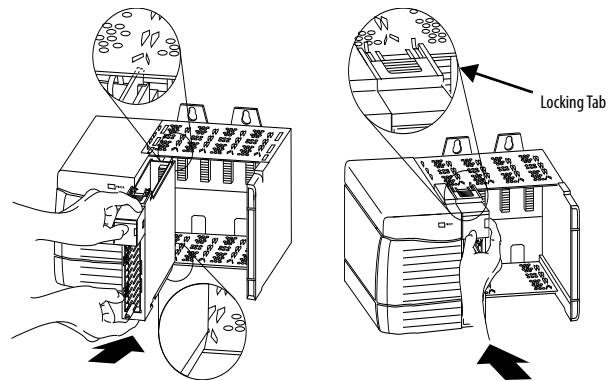

Key the Removable Terminal Block

Key the RTB to help prevent inadvertently connecting the incorrect RTB to your module.

1. Push the U-shaped band onto the module until the band snaps into place.
2. Insert wedge-shaped tabs into positions on the RTB that correspond to unkeyed module positions on the module until they stop.

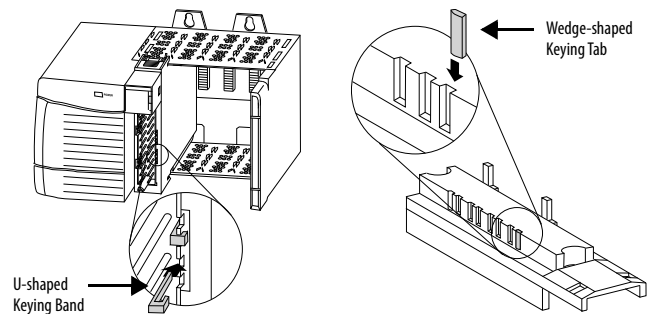

Connect Wiring

You can use an RTB or a Bulletin 1492 prewired interface module (IFM) to connect wires to your module. If you are using an RTB, see [Recommendations for Wiring Your RTB](#), to connect wires to the RTB. IFMs are prewired before shipping.



WARNING: If you connect or disconnect wiring while the field-side power is on, an electric arc can occur. This could cause an **explosion** in hazardous location installations. Be sure that power is removed or the area is nonhazardous before proceeding.



ATTENTION: If multiple power sources are used, do not exceed the specified isolation voltage.



ATTENTION: When using the 1756-TBNH, do not wire more than two 0.33...2.1 mm² (22...14 AWG) conductors on any single terminal. Use only the same size wires with no intermixing of solid and stranded wire types.

When using the 1756-TBSH, do not wire more than one conductor on any single terminal.



ATTENTION: The ControlLogix system has been agency certified using only the ControlLogix RTBs (1756-TBNH and 1756-TBSH). Any application that requires agency certification of the ControlLogix system using other wiring termination methods may require application-specific approval by the certifying agency.

Wire a Cage Clamp-style RTB

3. Insert the wire into the terminal.
4. Turn the screw clockwise to close the terminal on the wire.

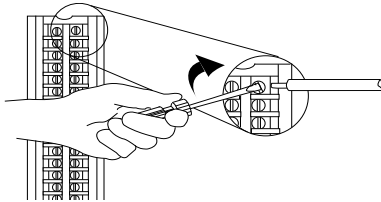

Wire a Spring Clamp

1. Insert the screwdriver into the outer hole of the RTB.
2. Insert the wire into the open terminal and remove the screwdriver.

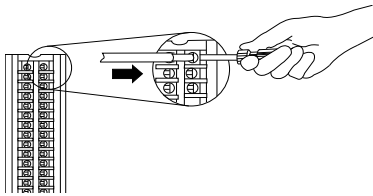

Recommendations for Wiring Your RTB

We recommend that you follow these guidelines when wiring your RTB:

- Begin wiring the RTB at the bottom terminals and move up.
- Use a tie to secure the wires in the strain relief (bottom) area of the RTB.
- Order and use an extended-depth housing (catalog number 1756-TBE) for applications that require heavy gauge wiring.

Assemble the RTB and the Housing

A removable housing covers the wired RTB to help protect the wiring connections when the RTB is seated on the module.

1. Align the grooves at the bottom of each side of the housing with the side edges of the RTB.

2. Slide the RTB into the housing until it snaps into place.

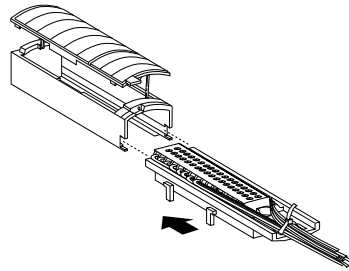

IMPORTANT If additional wire routing space is required for your application, use the extended-depth housing, catalog number 1756-TBE.

The housings that are shown are used with a spring clamp RTB, but the capacity for each remains the same regardless of RTB type.

Install the Removable Terminal Block

Follow these steps to install the RTB onto the module to connect the wiring.



WARNING: When you connect or disconnect the removable terminal block (RTB) with field-side power applied, an electric arc can occur. This could cause an **explosion** in hazardous location installations.

Be sure that power is removed or the area is nonhazardous before proceeding.

Before installing the RTB, verify the following:

- Field-side wiring of the RTB is complete.
- The RTB housing is snapped into place on the RTB.
- The RTB housing door is closed.
- The locking tab at the top of the module is unlocked.

1. Align the top, bottom, and left side guides of the RTB with the guides on the module.

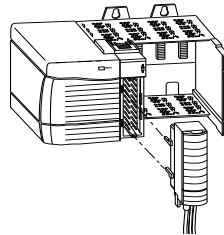

2. Press quickly and evenly to seat the RTB on the module until the latches snap into place.
3. Slide the locking tab down to lock the RTB onto the module.

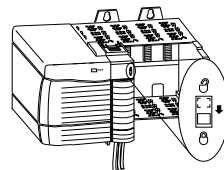

Specifications

Specifications: 1756-IA8D, 1756-IA8DK, 1756-IA16, 1756-IA16K, 1756-IA32, 1756-IA32K

Attribute	1756-IA8D, 1756-IA8DK	1756-IA16, 1756-IA16K	1756-IA32, 1756-IA32K
Temperature, operating • IEC 60068-2-1 (Test Ad, Operating Cold) • IEC 60068-2-2 (Test Bd, Operating Dry Heat) • IEC 60068-2-14 (Test Nb, Operating Thermal Shock)	0 °C < Ta < 60 °C (32 °F < Ta < 140 °F)		
Temperature, surrounding air, max	60 °C (140 °F)		
Enclosure type rating	None (open-style)		
Voltage and current ratings			
Backplane	• 5.1V DC, 100 mA • 24V DC, 3 mA	• 5.1V DC, 100 mA • 24V DC, 2 mA	• 5.1V DC, 165 mA • 24V DC, 2 mA
Inputs	120V AC, 50/60 Hz, 16 mA	120V AC, 50/60 Hz, 13 mA	74...132V AC, 50/60 Hz, 15 mA
Isolation voltage	• 125V (continuous) • Basic insulation type, inputs to backplane • No isolation between individual inputs		• 250V (continuous), basic insulation type, inputs to backplane • 125V (continuous), basic insulation type, input group to group • No isolation between individual inputs
Wire size	0.33...2.1 mm ² (22...14 AWG) solid or stranded copper wire that is rated at 90 °C (194 °F), or greater, 1.2 mm (3/64 in.) insulation max		
Wiring category ⁽¹⁾	1 - on signal ports		
North American temp code	T4A		

(1) Use this Conductor Category information for planning conductor routing. See Industrial Automation Wiring and Grounding Guidelines, publication [1770-4.1](#).

Specifications: 1756-IA16I, 1756-IA16IK, 1756-IM16I, 1756-IM16IK, 1756-OA8E, 1756-OA8EK, 1756-OA16I, 1756-OA16IK

Attribute	1756-IA16I, 1756-IA16IK	1756-IM16I, 1756-IM16IK	1756-OA8E, 1756-OA8EK	1756-OA16I, 1756-OA16IK
Temperature, operating • IEC 60068-2-1 (Test Ad, Operating Cold) • IEC 60068-2-2 (Test Bd, Operating Dry Heat) • IEC 60068-2-14 (Test Nb, Operating Thermal Shock)	0 °C < Ta < 60 °C (32 °F < Ta < 140 °F)			
Temperature, surrounding air, max	60 °C (140 °F)			
Enclosure type rating	None (open-style)			
Voltage and current ratings				
Backplane	• 5.1V DC, 125 mA • 24V DC, 3 mA	• 100 mA @ 5.1V DC • 3 mA @ 24V DC	• 200 mA @ 5.1V DC • 250 mA @ 24V DC	• 300 mA @ 5.1V DC • 2.5 mA @ 24V DC
Inputs	120V AC, 50/60 Hz, 15 mA	240V AC 50/60 HZ, 13 mA	—	—
Output	—	—	120V AC 50/60HZ, 2 A pilot duty	120/240V AC 50/60 HZ, 2 A pilot duty
Isolation voltage	125V (continuous), basic insulation type, inputs to backplane, and input to input	250V (continuous), basic insulation type, inputs to backplane, and input to input	• 125V (continuous), basic insulation type, outputs to backplane • No isolation between individual outputs	250V (continuous), basic insulation type, outputs to backplane, and output to output
Wire size	0.33...2.1 mm ² (22...14 AWG) solid or stranded copper wire rated at 90 °C (194 °F), or greater, 1.2 mm (3/64 in.) insulation max			
Wiring category ⁽¹⁾	1 - on signal ports			
North American temp code	T4A	T4	T4A	T4A

(1) Use this Conductor Category information for planning conductor routing. See Industrial Automation Wiring and Grounding Guidelines, publication [1770-4.1](#).

Specifications: 1756-IN16, 1756-IN16K, 1756-ON8, 1756-ON8K, 1756-OA8, 1756-OA8K, 1756-OA8D

Attribute	1756-IN16, 1756-IN16K	1756-ON8, 1756-ON8K	1756-OA8, 1756-OA8K	1756-OA8D
Temperature, operating • IEC 60068-2-1 (Test Ad, Operating Cold) • IEC 60068-2-2 (Test Bd, Operating Dry Heat) • IEC 60068-2-14 (Test Nb, Operating Thermal Shock)	0 °C < Ta < 60 °C (32 °F < Ta < 140 °F)			
Temperature, surrounding air, max	60 °C (140 °F)			
Enclosure type rating	None (open-style)			
Voltage and current ratings				
Backplane	• 5.1V DC, 135 mA • 24V DC, 2 mA	• 5.1V DC, 200 mA • 24V DC, 2 mA	• 5.1V DC, 200 mA • 24V DC, 2 mA	• 5.1V DC, 175 mA • 24V DC, 250 mA
Inputs	10...30V AC, 50/60 Hz 25 mA max	—	—	—
Output	—	24V AC, 50/60Hz, 2 A pilot duty (DC-13/SQ)	120/240V AC, 50/60 Hz, 2 A pilot duty	120V AC, 50/60 Hz, 1 A, 8 A surge
MDL	—	MDL: 5 A/4 A 30 °C (86 °F)/ 60 °C (140 °F)	—	—
ATEX/IECEx	—	10...30V AC	—	—
Isolation voltage	<ul style="list-style-type: none"> • 250V (continuous) • Basic insulation type, inputs to backplane, and input group to group • No isolation between individual channels 		<ul style="list-style-type: none"> • 250V (continuous), basic insulation type, outputs to backplane • No isolation between individual outputs 	<ul style="list-style-type: none"> • 125V (continuous), basic insulation type, outputs to backplane • No isolation between individual outputs
Wire size	<p>1756-TBNH</p> <ul style="list-style-type: none"> • Single wire connection: 0.33...2.1 mm² (22...14 AWG) solid or stranded shielded copper wire rated at 105 °C (221 °F), or greater, 1.2 mm (3/64 in.) insulation max • Double wire connection: 0.33...1.3 mm² (22...16 AWG) solid or stranded copper wire rated at 105 °C (221 °F), or greater, 1.2 mm (3/64 in.) insulation max <p>1756-TBSH</p> <ul style="list-style-type: none"> • Single wire connection: 0.33...2.1 mm² (22...14 AWG) solid or stranded shielded copper wire rated at 105 °C (221 °F), or greater, 1.2 mm (3/64 in.) insulation max 		0.33...2.1 mm ² (22...14 AWG) solid or stranded copper wire rated at 90 °C (194 °F), or greater, 1.2 mm (3/64 in.) insulation max	
Wiring category ⁽¹⁾	1 - on signal ports			
Terminal block torque	1756-TBNH 0.36 N•m (12 lb•in)			
North American temp code	T3C	T4A		

(1) Use this Conductor Category information for planning conductor routing. See Industrial Automation Wiring and Grounding Guidelines, publication [1770-4.1](#).

Specifications: 1756-0A16, 1756-0A16K

Attribute	1756-0A16, 1756-0A16K
Temperature, operating IEC 60068-2-1 (Test Ad, Operating Cold), IEC 60068-2-2 (Test Bd, Operating Dry Heat), IEC 60068-2-14 (Test Nb, Operating Thermal Shock)	0...60 °C (32...140 °F)
Temperature, surrounding air, max	60 °C (140 °F)
Enclosure type rating	None (open style)
Voltage and current ratings	
Backplane	<ul style="list-style-type: none"> • 5.1V DC, 400 mA • 24V DC, 2 mA
Outputs	120/240V AC, 50/60 Hz, 0.5 A pilot duty
Isolation voltage	250V (continuous), basic insulation type, outputs to backplane, and output to output
Wire size	0.33...2.1 mm ² (22...14 AWG) solid or stranded copper wire rated at 90 °C (194 °F), or greater, 1.2 mm ² (3/64 in.) insulation max
Wiring category ⁽¹⁾	1 - on signal ports
Terminal block torque	1756-TBNH 0.36 N·m (12 lb·in)
North American temp code	T4

(1) Use this Conductor Category information for planning conductor routing. See Industrial Automation Wiring and Grounding Guidelines, publication [1770-4.1](#).

Additional Resources

These resources contain information about related products from Rockwell Automation.

Resource	Description
ControlLogix I/O Modules Specifications Technical Data, publication 1756-TD002	Provides specifications, wiring diagrams, and schematics for ControlLogix I/O modules.
ControlLogix Digital I/O Modules User Manual, publication 1756-UM058	Provides installation, configuration, operation, and maintenance information for ControlLogix digital I/O modules.
Industrial Automation Wiring and Grounding Guidelines, publication 1770-4.1	Provides general guidelines for installing a Rockwell Automation industrial system.
Product Certifications website, rok.auto/certifications	Provides declarations of conformity, certificates, and other certification details.

Notes:

Rockwell Automation Support

Use the following resources to access support information.

Technical Support Center	Knowledgebase Articles, How-to Videos, FAQs, Chat, User Forums, and Product Notification Updates.	https://rockwellautomation.custhelp.com/
Local Technical Support Phone Numbers	Locate the phone number for your country.	http://www.rockwellautomation.com/global/support/get-support-now.page
Direct Dial Codes	Find the Direct Dial Code for your product. Use the code to route your call directly to a technical support engineer.	http://www.rockwellautomation.com/global/support/direct-dial.page
Literature Library	Installation Instructions, Manuals, Brochures, and Technical Data.	http://www.rockwellautomation.com/global/literature-library/overview.page
Product Compatibility and Download Center (PCDC)	Get help determining how products interact, check features and capabilities, and find associated firmware.	http://www.rockwellautomation.com/global/support/pcdc.page

Documentation Feedback

Your comments will help us serve your documentation needs better. If you have any suggestions on how to improve this document, complete the How Are We Doing? form at http://literature.rockwellautomation.com/idc/groups/literature/documents/du/ra-du002_-en-e.pdf.

Rockwell Automation maintains current product environmental information on its website at <http://www.rockwellautomation.com/rockwellautomation/about-us/sustainability-ethics/product-environmental-compliance.page>.

Allen-Bradley, ControlLogix, Rockwell Automation, and Rockwell Software are trademarks of Rockwell Automation, Inc. Trademarks not belonging to Rockwell Automation are property of their respective companies.

Rockwell Otomasyon Ticaret A.Ş., Kar Plaza İş Merkezi E Blok Kat:6 34752 İçerenköy, İstanbul, Tel: +90 (216) 5698400

www.rockwellautomation.com

Power, Control and Information Solutions Headquarters

Americas: Rockwell Automation, 1201 South Second Street, Milwaukee, WI 53204-2496 USA, Tel: (1) 414.382.2000, Fax: (1) 414.382.4444
Europe/Middle East/Africa: Rockwell Automation NV, Pegasus Park, De Kleetlaan 12a, 1831 Diegem, Belgium, Tel: (32) 2 663 0600, Fax: (32) 2 663 0640
Asia Pacific: Rockwell Automation, Level 14, Core F, Cyberport 3, 100 Cyberport Road, Hong Kong, Tel: (852) 2887 4788, Fax: (852) 2508 1846

Publication 1756-IN064C-EN-P - June 2019

Supersedes Publication 1756-IN064B-EN-P - October 2018

PN-539090

Copyright © 2019 Rockwell Automation, Inc. All rights reserved. Printed in the U.S.A.