

SLC 500 EtherNet/IP Adapter

Catalog Number 1747-AENTR

Topic	Page
Important User Information	2
North American Hazardous Location Approval	4
Additional Resources	5
Overview	5
Install the Adapter Module in the Chassis	9
Connect Your Adapter to the Ethernet/IP Network through RJ-45 Connection	10
Troubleshoot with Status Indicators and Status Display	11
Specifications	15

Important User Information

Solid-state equipment has operational characteristics differing from those of electromechanical equipment. Safety Guidelines for the Application, Installation and Maintenance of Solid State Controls (publication [SGL-1.1](#) available from your local Rockwell Automation sales office or online at <http://www.rockwellautomation.com/literature/>) describes some important differences between solid-state equipment and hard-wired electromechanical devices. Because of this difference, and also because of the wide variety of uses for solid-state equipment, all persons responsible for applying this equipment must satisfy themselves that each intended application of this equipment is acceptable.





In no event will Rockwell Automation, Inc. be responsible or liable for indirect or consequential damages resulting from the use or application of this equipment.

The examples and diagrams in this manual are included solely for illustrative purposes. Because of the many variables and requirements associated with any particular installation, Rockwell Automation, Inc. cannot assume responsibility or liability for actual use based on the examples and diagrams.

No patent liability is assumed by Rockwell Automation, Inc. with respect to use of information, circuits, equipment, or software described in this manual.

Reproduction of the contents of this manual, in whole or in part, without written permission of Rockwell Automation, Inc., is prohibited.

Throughout this manual, when necessary, we use notes to make you aware of safety considerations.

	WARNING: Identifies information about practices or circumstances that can cause an explosion in a hazardous environment, which may lead to personal injury or death, property damage, or economic loss.
	ATTENTION: Identifies information about practices or circumstances that can lead to personal injury or death, property damage, or economic loss. Attentions help you identify a hazard, avoid a hazard and recognize the consequences.
	SHOCK HAZARD: Labels may be on or inside the equipment (for example, drive or motor) to alert people that dangerous voltage may be present.
	BURN HAZARD: Labels may be on or inside the equipment (for example, drive or motor) to alert people that surfaces may reach dangerous temperatures.
IMPORTANT	Identifies information that is critical for successful application and understanding of the product.

Environment and Enclosure



ATTENTION: This equipment is intended for use in a Pollution Degree 2 industrial environment, in overvoltage Category II applications (as defined in IEC 60664-1), at altitudes up to 2000 m (6562 ft) without derating. This equipment is considered Group 1, Class A industrial equipment according to IEC/CISPR 11. Without appropriate precautions, there may be difficulties with electromagnetic compatibility in residential and other environments due to conducted and radiated disturbances. This equipment is supplied as open-type equipment. It must be mounted within an enclosure that is suitably designed for those specific environmental conditions that will be present and appropriately designed to prevent personal injury resulting from accessibility to live parts. The enclosure must have suitable flame-retardant properties to prevent or minimize the spread of flame, complying with a flame spread rating of 5VA, or be approved for the application, if non-metallic. The interior of the enclosure must be accessible only by the use of a tool. Subsequent sections of this publication may contain additional information regarding specific enclosure type ratings that are required to comply with certain product safety certifications. In addition to this publication, see:

- Industrial Automation Wiring and Grounding Guidelines, Rockwell Automation publication [1770-4.1](#), for additional installation requirements.
- NEMA Standard 250 and IEC 60529, as applicable, for explanations of the degrees of protection provided by different types of enclosure.

Preventing Electrostatic Discharge





ATTENTION: This equipment is sensitive to electrostatic discharge, which can cause internal damage and affect normal operation. Follow these guidelines when you handle this equipment:

- Touch a grounded object to discharge potential static.
 - Wear an approved grounding wriststrap.
 - Do not touch connectors or pins on component boards.
 - Do not touch circuit components inside the equipment.
 - Use a static-safe workstation, if available.
 - Store the equipment in appropriate static-safe packaging when not in use.
-

North American Hazardous Location Approval

The 1747-AENTR module is North American Hazardous Location approved.

The following information applies when operating this equipment in hazardous locations:	Informations sur l'utilisation de cet équipement en environnements dangereux:
<p>Products marked "CL I, DIV 2, GP A, B, C, D" are suitable for use in Class I Division 2 Groups A, B, C, D, Hazardous Locations and nonhazardous locations only. Each product is supplied with markings on the rating nameplate indicating the hazardous location temperature code. When combining products within a system, the most adverse temperature code (lowest "T" number) may be used to help determine the overall temperature code of the system. Combinations of equipment in your system are subject to investigation by the local Authority Having Jurisdiction at the time of installation.</p>	<p>Les produits marqués "CL I, DIV 2, GP A, B, C, D" ne conviennent qu'à une utilisation en environnements de Classe I Division 2 Groupes A, B, C, D dangereux et non dangereux. Chaque produit est livré avec des marquages sur sa plaque d'identification qui indiquent le code de température pour les environnements dangereux. Lorsque plusieurs produits sont combinés dans un système, le code de température le plus défavorable (code de température le plus faible) peut être utilisé pour déterminer le code de température global du système. Les combinaisons d'équipements dans le système sont sujettes à inspection par les autorités locales qualifiées au moment de l'installation.</p>
<div style="display: flex; align-items: center;">  <div> <p>EXPLOSION HAZARD</p> <ul style="list-style-type: none"> • Do not disconnect equipment unless power has been removed or the area is known to be nonhazardous. • Do not disconnect connections to this equipment unless power has been removed or the area is known to be nonhazardous. Secure any external connections that mate to this equipment by using screws, sliding latches, threaded connectors, or other means provided with this product. • Substitution of any component may impair suitability for Class I, Division 2. • If this product contains batteries, they must only be changed in an area known to be nonhazardous. </div> </div>	<div style="display: flex; align-items: center;">  <div> <p>RISQUE D'EXPLOSION</p> <ul style="list-style-type: none"> • Couper le courant ou s'assurer que l'environnement est classé non dangereux avant de débrancher l'équipement. • Couper le courant ou s'assurer que l'environnement est classé non dangereux avant de débrancher les connecteurs. Fixer tous les connecteurs externes reliés à cet équipement à l'aide de vis, loquets coulissants, connecteurs filetés ou autres moyens fournis avec ce produit. • La substitution de tout composant peut rendre cet équipement inadapté à une utilisation en environnement de Classe I, Division 2. • S'assurer que l'environnement est classé non dangereux avant de changer les piles. </div> </div>



WARNING: When you insert or remove the module while backplane power is on, an electrical arc can occur. This could cause an explosion in hazardous location installations.

Be sure that power is removed or the area is nonhazardous before proceeding. Repeated electrical arcing causes excessive wear to contacts on both the module and its mating connector. Worn contacts may create electrical resistance that can affect module operation.



WARNING: When used in a Class I, Division 2, hazardous location, this equipment must be mounted in a suitable enclosure with proper wiring method that complies with the governing electrical codes.



ATTENTION: Electrostatic discharge can damage semiconductor devices inside the module. Do not touch the connector pins or other sensitive areas.

ATTENTION: This equipment must be powered from Allen-Bradley power supply models 1746-P1, 1746-P2, 1746-P3, 1746-P4, 1746-P5, 1746-P6, or 1746-P7. Do not use the 1746-P4 device in UL Class 1, Division 2, Hazardous Locations.

ATTENTION: Do not remove the protective debris strips until after the controller and all other equipment in the panel near the module are mounted and wired. Remove strips before operating the controller. Failure to remove strips before operating can cause overheating.

ATTENTION: Be careful when stripping wires. Wire fragments that fall into the controller could cause damage. Once wiring is complete, make sure the controller is free of all metal fragments.

ATTENTION: Do not remove or replace the Adapter Module while power is applied. Interruption of the backplane can result in unintentional operation or machine motion.

Additional Resources

Resource	Description
SLC™ 500 EtherNet/IP Adapter Programmable Controllers User Manual, publication 1747-UM076	A more detailed description of how to install and use your SLC™ 500 EtherNet/IP Adapter.
Industrial Automation Wiring and Grounding Guidelines, publication 1770-4.1	More information on proper wiring and grounding techniques.

If you would like a manual, you can:

- download a free electronic version from the Internet:
<http://rockwellautomation.com/literature>
- purchase a printed manual by contacting your local Allen-Bradley distributor or Rockwell Automation representative

Overview

The SLC EtherNet/IP Adapter allows SLC I/O to be controlled by a CompactLogix or ControlLogix processor. The module is intended for use when migrating existing SLC controlled systems to a Logix-based controller.

This module does not support SLC I/O modules that require G files or any communication modules that are attached to the same chassis as the adapter. See the 1747-AENTR User Manual, publication [1747-UM076](#), for a complete list of modules that are supported by this module.

Any Rockwell Automation CIP connection originating device can communicate and share I/O data through the 1747-AENTR.

The 1747-AENTR adapter features :

- One exclusive owner connection per SLC module (the ability to connect to partial sets of I/O and rack connections are not supported on firmware revision 1.001)
- Up to 5 Input Only connections per module
- Up to 5 Listen Only connections per module
- Up to 5 explicit messaging connections to the adapter
- Up to 5 consumers per multicast connection

IMPORTANT On firmware revision 2.001 and later, the 1747-AENTR adapter additionally supports direct connections to rack extensions, including:

- Up to 96 Class 1 connections;
- Up to 8 Class 3 connections.

Hardware Components

The adapter module consists of the following major components.

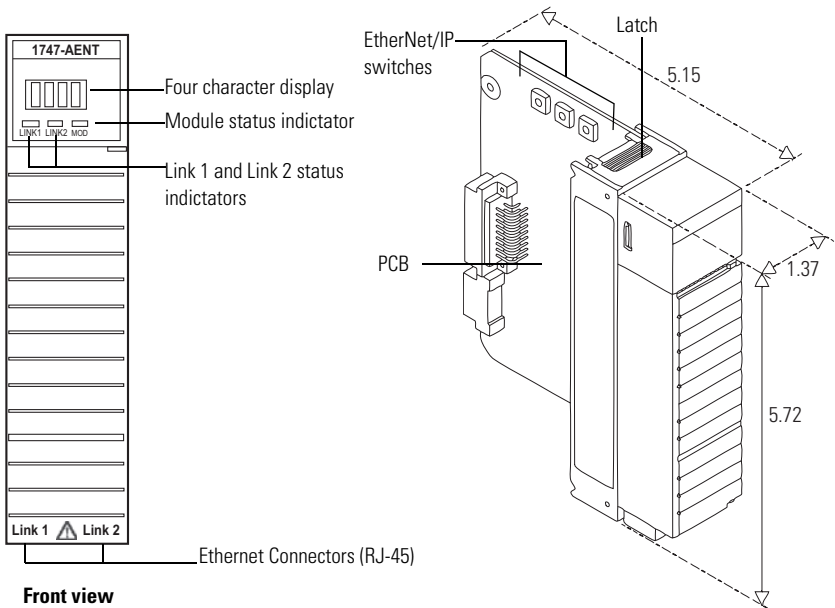

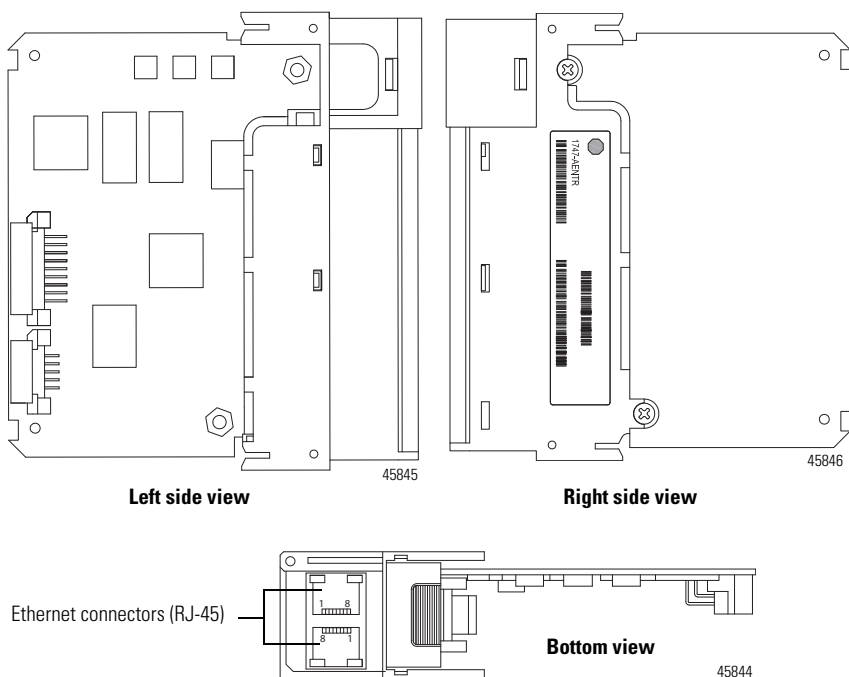

Diagnostic Indicators

Health indicators are located on the front panel of the adapter module. They indicate both normal operation and error conditions in your remote I/O system.

An alphanumeric display (net address/status) provides status code indications when an error occurs during initialization or operation.

A complete description of the diagnostic indicators and status display and how to use them for troubleshooting is explained on page 11.

Understand Messaging

Class 3 (Explicit Message) requests through the 1747-AENTR adapter to a specific I/O module may not always receive a response from the I/O modules. In the case where the I/O module does not reply to the request, the adapter responds with an error code indicating a time-out.

Establish I/O Connections

When you start a system and establish I/O connections, the outputs transition to the Idle state, applying Idle state data before going to Run mode. This occurs even when the controller making the connection is already in Run mode.

Set the Network Address

The network address switches are set to 999 and DHCP enabled, by default. You can set the network Internet Protocol (IP) address in the following ways:

- Use the network address switches on the module.
- Use a Dynamic Host Configuration Protocol (DHCP) server, such as Rockwell Automation BootP/DHCP.
- Retrieve the IP address from nonvolatile memory.

The adapter reads the network address switches first to determine if the switches are set to a valid number. You set the node address by using the network address switches. Valid settings range from 001...254.

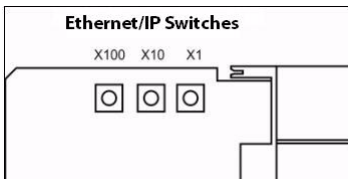

When the switches are set to a valid number, the adapter's IP address is 192.168.1.xxx (where xxx represents the number set on the switches).

The adapter's subnet mask is 255.255.255.0 and the gateway address is set to 0.0.0.0. The adapter does not have a host name assigned, or use any Domain Name System when using the network address switch settings.

If the switches are set to an invalid number (for example, 000 or a value greater than 254 excluding 888⁽¹⁾), the adapter checks to see if DHCP is enabled.

Refer to publication SLC Ethernet/IP Adapter User Manual, [1747-UM076](#), for detailed information on IP address configuration.

DHCP Enabled and Not Enabled

If DHCP is	Then the Adapter
Enabled	<p>Asks for an address from a DHCP server. The DHCP server also assigns other Transport Control Protocol (TCP) parameters.</p> <p>The 1747-AENTR factory default is DHCP enabled. When you apply power, the module sends a message containing its hardware address to any DHCP server on the network. The server(s) replies by sending a message with an appropriate IP address for the adapter. The adapter responds by acknowledging to a server that it will use the offered IP address.</p>
Not enabled	<p>Uses the IP address (along with other TCP configurable parameters) stored in nonvolatile memory.</p> <p>When the IP address assigned to the module, as indicated in the four-character dot matrix status display, is changed through the DHCP configuration utility, the DHCP is disabled.</p> <p>When power is cycled to the device, it uses the new configuration and implements the new IP address.</p>

⁽¹⁾ Setting the network switches to 888 restores default factory settings.

TIP Rockwell Automation recommends that you check or enable the option “Major Fault On Controller If Connection Fails While in Run Mode” on both the 1747-AENTR device and supported 1746 I/O modules.

For a step-by-step guide on how to configure your adapter module through the RSLogix 5000 or Logix Designer application, see the User Manual for the SLC 500 EtherNet/IP Adapter, publication [1747-UM076](#).

Install the Adapter Module in the Chassis

After you set the appropriate switch assemblies for your adapter module, follow these procedures for installation.

Refer to the *Industrial Controller Wiring and Grounding Guidelines* publication [1770-4.1](#) for proper grounding and wiring methods to use when installing your module.

1. Remove power from the I/O chassis before inserting (or removing) the module.
2. Align the circuit board with the chassis card guide in the left slot.

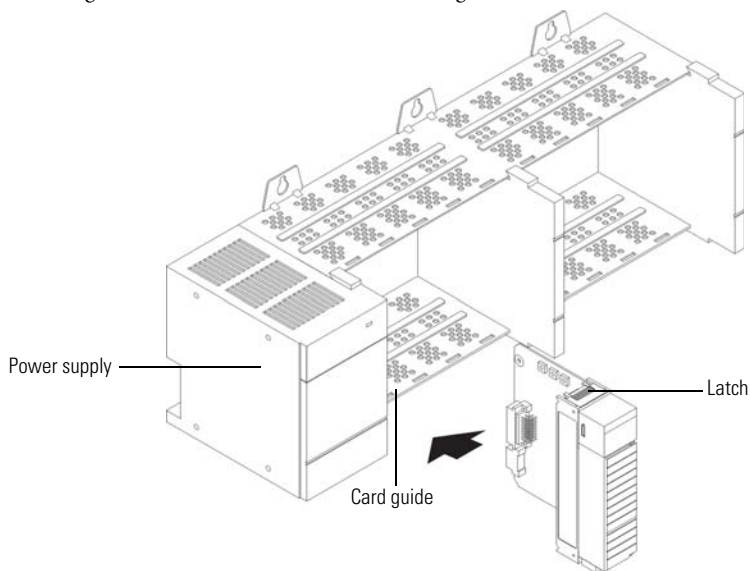

3. Install the module in slot 0 of the chassis by aligning the circuit board with the chassis card guide.
The 1747-AENTR module must be installed only in slot 0 (leftmost slot) of the chassis.
4. Press firmly and evenly to seat the module in its backplane connectors. To remove the module, press the releases at the top and bottom of the module and pull it out.



ATTENTION: Do not force the module into the backplane connector. If you cannot seat the module with firm pressure, check the alignment. Forcing the module can damage the backplane connector or the module.

IMPORTANT

The 1747-AENTR device should always be installed in Slot 0. There should only be one 1747-AENTR device installed within the same rack or its connected rack extensions for multiple chassis support.

Connect Your Adapter to the Ethernet/IP Network through RJ-45 Connection

Connect your 1747-AENTR adapter module to an Ethernet/IP network as shown below: Wire the RJ-45 connectors as shown.

	Signal
1	TxData+
2	TxData-
3	Recv Data+
4	Reserved
5	Reserved
6	Recv Data-
7	Reserved
8	Reserved

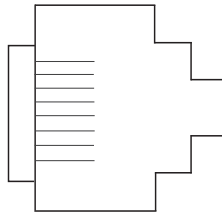

RJ-45

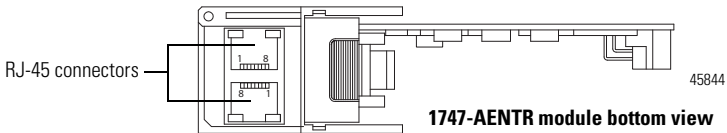

To connect the module to the network, follow these steps:



WARNING: If you connect or disconnect the communication cable with power applied to this module or any device on the network, an electrical arc can occur. This could cause an explosion in hazardous location installations. Be sure that power is removed or the area is nonhazardous before proceeding.

1. Attach the cables with the RJ-45 connectors to the two Ethernet ports on the bottom of the module.

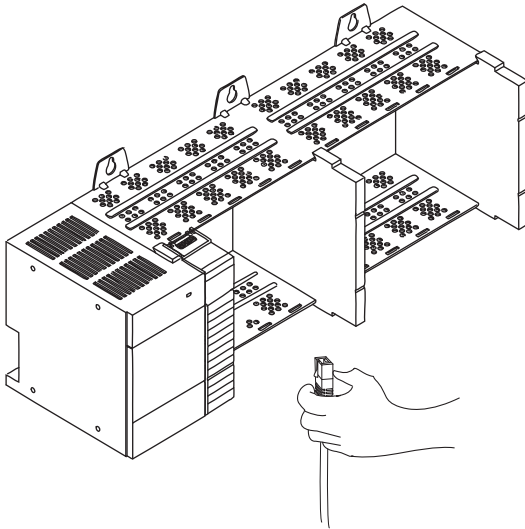

2. Attach the other end of the cables to the devices in your network.

IMPORTANT For information on how to install systems with rack extensions, you can refer to the SLC 500 Modular Hardware Style User Manual, publication [1747-UM011](#).

Troubleshoot with Status Indicators and Status Display

The module has indicators on the front panel as shown below.

Use these indicators to troubleshoot the module.

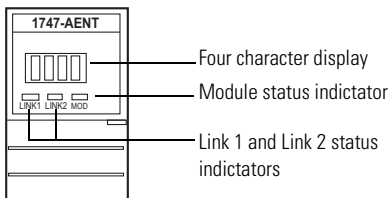

The following table describes how to use the indicators to troubleshoot your module.

Interpret the Status Indicators

Indicator	State	Description
Module	Off	No power applied to device
	Green	Device operating normally
	Flashing green	Device has not been configured
	Flashing red	Recoverable fault. <ul style="list-style-type: none"> • IP Address switches do not match configuration in use. • The device has completed a reset to factory default request because the switches were set to 888 at powerup, and a power cycle is required. • The device is performing a firmware flash update.
	Red	Unrecoverable fault, may require device replacement
4 Character Display		Displays IP address and module status description. See table, Four-character Status Display, for a description of all the possible module status.
Link 1 or Link 2	Off	No link established.
	Solid green	Link established @ 100 Mbps.
	Flashing green	Transmit or receive activity present on indicated port @ 100 Mbps.
	Solid yellow	Link established @ 10 Mbps.
	Flashing yellow	Transmit or receive activity present on indicated port @ 10 Mbps.

The four-character display indicates module status as shown in the table below.

Four-character Status Display

MOD LED	Display	Description	Probable Cause	Recommended Action
System startup				
Red-green flash followed by Solid Red	Dotted display on	Module is performing Power On Self Test (POST)	None	None
Green	"OK" (The first scroll cycle displays the software revision in the format "Rev majorRev.minorRev. subMinorRev")	POST is successful	None	None
Red	4-digit error hex code (For example, 0100 and 0101)	POST Failure (0100 = IOFPGA failure) (0101=ESFPGA failure)	The adapter has either failed a hardware test, or gone into a state from which it cannot recover.	Document the error codes. Power cycle the adapter. Contact Technical Support.

Four-character Status Display

MOD LED	Display	Description	Probable Cause	Recommended Action
Flashing Red	"OK" alternates with the message: "Factory Defaults Restored. Change Address Switches and Reset."	Factory defaults restored	Node switches have been set to 888. The AENTR remains in this mode until the switches are changed.	Power off the adapter. Remove the adapter from the chassis. Change the node address switch to something other than 888. Replace the adapter in the chassis, and apply power.
Runtime				
Flashing green	"OK" alternates with "Port x baud/dpx" where: x = port number 1 or 2 baud = Link rate, "10" or "100" dpx = "FULL" or "HALF"	Module is communicating.	None	None
	"OK" alternates with "Port x down"	Module is not communicating.	Ethernet port is not connected.	Connect Ethernet port.
	"OK" alternates with "BOOTP XX:XX:XX:XX:XX" or "DHCP XX:XX:XX:XX:XX"	Module is on network waiting for IP address	None	Use RSLinx BootP-DHCP server or set IP statically with thumb wheel switches.
Flashing red	"Duplicate IP XX:XX:XX:XX:XX"	Module is not communicating	The adapter has detected a duplicate node address on the network.	Correct the duplicate node to address problem.
	"Flash update in progress"	Firmware update mode	Adapter firmware is being updated via ControlFlash update utility	None
	"Corrupt Certificate Received"	Firmware update failure	Firmware update with invalid security certificate attempted.	Ensure that you have a valid security certificate to download firmware.
	"Corrupt Image Received"	Firmware update failure	Firmware update with corrupt image has been attempted.	Make sure proper ControlFLASH update procedure is followed. Retry update.

Four-character Status Display

MOD LED	Display	Description	Probable Cause	Recommended Action
Solid green	<IP address>	Module is communicating and working properly.	None	None
Solid Red	"0001"	Fatal error	The adapter has failed a hardware test, discovered too many I/O racks (greater than 3), or reached a state from which it cannot recover.	Verify the correct number of I/O racks and power cycle the adapter. Contact Technical Support if problem persists.

Powerup Sequence

On powerup, the module performs the following in sequence.

1. RAM test
2. Flash image verification
3. Load image from flash and execute
4. Initialize LED and display handler
5. Initialize DLR
6. Check configuration switches and initialize TCP/IP
7. Initialize 1746 backplane
8. Initialize main application
 - a. Create CIP Objects
 - b. Initialize Ethernet/IP stack
 - c. Create I/O manager
9. Initial DUP ID (duplicate ID) check
10. Initialize Web server
11. Enable I/O and messaging

Specifications

Ethernet Communication

Attribute	Value
EtherNet communication rate	10/100 Mbps/s, half or full-duplex
Ethernet ports	2, configured as Embedded Switch
Ethernet network topologies supported	Star, Tree, Daisy chain/Linear, and Ring
Ethernet connector	RJ-45, Category 5
Ethernet cable	Category 5: shielded or unshielded

General Specifications

Attribute	Value
Module location	Always at Slot 0 (leftmost slot) on chassis
Current consumption, backplane	470 mA @ 5V DC
Thermal dissipation	2.49 W = 8.4962 Btu (IT)/hour
Isolation voltage	50V (continuous), Basic Insulation Type
Dimensions (HxWxD), approx.	145.3 x 34.8 x 130.8 mm (5.72 x 1.37 x 5.15 in.)
Enclosure type rating	None (open-style)
Wiring category ⁽¹⁾	1 – on communication ports
Weight, approx.	168 g (0.37 lbs.)
North American temp code	T3C

⁽¹⁾ Use this Conductor Category information for planning conductor routing. Refer to Industrial Automation Wiring and Grounding Guidelines, publication [1770-4.1](#).

Environmental Specifications

Attribute	Value
Temperature, operating	IEC 60068-2-1 (Test Ad, Operating Cold), IEC 60068-2-2 (Test Bd, Operating Dry Heat), IEC 60068-2-14 (Test Nb, Operating Thermal Shock): 0...60 °C (32...140 °F)
Temperature, nonoperating	IEC 60068-2-1 (Test Ab, Unpackaged Non-operating Cold), IEC 60068-2-2 (Test Bb, Unpackaged Non-operating Dry Heat), IEC 60068-2-14 (Test Na, Unpackaged Non-operating Thermal Shock): -40...85 °C (-40...185 °F)
Temperature, surrounding air, max	60 °C (140°F)
Relative humidity	IEC 60068-2-30 (Test Db, Unpackaged Damp Heat): 5...95% noncondensing
Vibration	IEC 60068-2-6 (Test Fc, Operating): 2.5g @ 57...2000 Hz
Shock, operating	IEC 60068-2-27 (Test Ea, Unpackaged Shock): 30 g
Shock, nonoperating	IEC 60068-2-27 (Test Ea, Unpackaged Shock): 50 g
Emissions	CISPR 11: Group 1, Class A
ESD immunity	IEC 61000-4-2: 6 kV contact discharges 8 kV air discharges
Radiated RF immunity	IEC 61000-4-3: 10V/m with 1KHz sine-wave 80% AM from 80...2000 MHz 10V/m with 200 Hz 50% Pulse 100% AM @ 900 MHz 10V/m, with 200 Hz 50% Pulse 100% AM @ 1890 MHz 10V/m with 1KHz sine-wave 80% AM from 2000...2700 MHz
EFT/B immunity	IEC 61000-4-4: ±3 kV @ 5 kHz on communication ports
Surge transient immunity	IEC 61000-4-5: ±2 kV line-earth(CM) on communication ports
Conducted RF immunity	IEC 61000-4-6: 10V rms with 1 kHz sine-wave 80% AM from 150 kHz...80 MHz

Certifications

Certification (when product is marked)⁽¹⁾	Value
c-UL-us	UL Listed Industrial Control Equipment, certified for US and Canada. See UL File E322657. UL Listed for Class I, Division 2 Group A, B, C, D Hazardous Locations, certified for U.S. and Canada. See UL File E334470.
CE	European Union 2004/108/EC EMC Directive, compliant with: EN 61326-1; Meas./Control/Lab., Industrial Requirements EN 61000-6-2; Industrial Immunity EN 61000-6-4; Industrial Emissions EN 61131-2; Programmable Controllers (Clause 8, Zone A & B)
C-Tick	Australian Radiocommunications Act, compliant with: AS/NZS CISPR 11; Industrial Emissions
EtherNet/IP	ODVA conformance tested to EtherNet/IP specifications
KC	Korean Registration of Broadcasting and Communications Equipment, compliant with: Article 58-2 of Radio Waves Act, Clause 3

⁽¹⁾ See the Product Certification link at <http://www.rockwellautomation.com/products/certification/> for Declaration of Conformity, Certificates, and other certification details.

Notes:

Rockwell Automation Support

Rockwell Automation provides technical information on the Web to assist you in using its products. At <http://www.rockwellautomation.com/support/>, you can find technical manuals, a knowledge base of FAQs, technical and application notes, sample code and links to software service packs, and a MySupport feature that you can customize to make the best use of these tools.

For an additional level of technical phone support for installation, configuration and troubleshooting, we offer TechConnect support programs. For more information, contact your local distributor or Rockwell Automation representative, or visit <http://www.rockwellautomation.com/support/>.

Installation Assistance

If you experience a problem within the first 24 hours of installation, please review the information that's contained in this manual. You can also contact a special Customer Support number for initial help in getting your product up and running.

United States or Canada	1.440.646.3434
Outside United States or Canada	Use the Worldwide Locator at http://www.rockwellautomation.com/support/americas/phone_en.html , or contact your local Rockwell Automation representative.

New Product Satisfaction Return

Rockwell Automation tests all of its products to ensure that they are fully operational when shipped from the manufacturing facility. However, if your product is not functioning and needs to be returned, follow these procedures.

United States	Contact your distributor. You must provide a Customer Support case number (call the phone number above to obtain one) to your distributor to complete the return process.
Outside United States	Please contact your local Rockwell Automation representative for the return procedure.

Documentation Feedback

Your comments will help us serve your documentation needs better. If you have any suggestions on how to improve this document, complete this form, publication [BA-DU002](#), available at <http://www.rockwellautomation.com/literature/>.

Allen-Bradley, Rockwell Software, Rockwell Automation, SLC, and TechConnect are trademarks of Rockwell Automation, Inc.

Trademarks not belonging to Rockwell Automation are property of their respective companies.

Rockwell Otomasyon Ticaret A.Ş., Kar Plaza İş Merkezi E Blok Kat:6 34752 İçerenköy, İstanbul, Tel: +90 (216) 5698400

www.rockwellautomation.com

Power, Control and Information Solutions Headquarters

Americas: Rockwell Automation, 1201 South Second Street, Milwaukee, WI 53204-2496 USA, Tel: (1) 414.382.2000, Fax: (1) 414.382.4444
Europe/Middle East/Africa: Rockwell Automation NV, Pegasus Park, De Kleetlaan 12a, 1831 Diegem, Belgium, Tel: (32) 2 663 0600, Fax: (32) 2 663 0640
Asia Pacific: Rockwell Automation, Level 14, Core F, Cyberport 3, 100 Cyberport Road, Hong Kong, Tel: (852) 2887 4788, Fax: (852) 2508 1846

Publication 1747-IN521B-EN-E - January 2013

Supersedes Publication 1747-IN521A-EN-E - February 2012

Copyright © 2013 Rockwell Automation, Inc. All rights reserved.