



ArmorPOINT RTD and Thermocouple Input Modules

Catalog numbers 1738-IR2M12, 1738-IT2IM12, Series A

Table of Contents

Topic	Page
Important User Information	2
Environment and Enclosure	3
Preventing Electrostatic Discharge	3
About the Module	4
Mount the I/O Base	5
Install the Module	6
Remove the Module from the Mounting Base	6
Wire the Module	7
Communicate with the Module	8
Interpret Status Indicators	10
Specifications	12

Important User Information

Solid-state equipment has operational characteristics differing from those of electromechanical equipment. Safety Guidelines for the Application, Installation and Maintenance of Solid State Controls (Publication [SGI-1.1](#) available from your local Rockwell Automation sales office or online at <http://www.rockwellautomation.com/literature/>) describes some important differences between solid-state equipment and hard-wired electromechanical devices. Because of this difference, and also because of the wide variety of uses for solid-state equipment, all persons responsible for applying this equipment must satisfy themselves that each intended application of this equipment is acceptable.





In no event will Rockwell Automation, Inc. be responsible or liable for indirect or consequential damages resulting from the use or application of this equipment.

The examples and diagrams in this manual are included solely for illustrative purposes. Because of the many variables and requirements associated with any particular installation, Rockwell Automation, Inc. cannot assume responsibility or liability for actual use based on the examples and diagrams.

No patent liability is assumed by Rockwell Automation, Inc. with respect to use of information, circuits, equipment, or software described in this manual.

Reproduction of the contents of this manual, in whole or in part, without written permission of Rockwell Automation, Inc., is prohibited.

Throughout this manual, when necessary, we use notes to make you aware of safety considerations.

	WARNING: Identifies information about practices or circumstances that can cause an explosion in a hazardous environment, which may lead to personal injury or death, property damage, or economic loss.
	ATTENTION: Identifies information about practices or circumstances that can lead to personal injury or death, property damage, or economic loss. Attentions help you identify a hazard, avoid a hazard and recognize the consequences.
	SHOCK HAZARD: Labels may be on or inside the equipment (for example, drive or motor) to alert people that dangerous voltage may be present.
	BURN HAZARD: Labels may be on or inside the equipment (for example, drive or motor) to alert people that surfaces may reach dangerous temperatures.
IMPORTANT	Identifies information that is critical for successful application and understanding of the product.

Environment and Enclosure



ATTENTION: This equipment is intended for use in overvoltage Category II applications (as defined in IEC 60664-1), at altitudes up to 2000 m (6562 ft) without derating.

This equipment is considered Group 1, Class A industrial equipment according to IEC/CISPR 11. Without appropriate precautions, there may be difficulties with electromagnetic compatibility in residential and other environments due to conducted and radiated disturbances.

This equipment is supplied as enclosed equipment. It should not require additional system enclosure when used in locations consistent with the enclosure type ratings stated in the Specifications section of this publication. Subsequent sections of this publication may contain additional information regarding specific enclosure type ratings, beyond what this product provides, that are required to comply with certain product safety certifications.

In addition to this publication, see:

- Industrial Automation Wiring and Grounding Guidelines, Rockwell Automation publication [1770-4.1](#), for additional installation requirements.
- NEMA Standard 250 and IEC 60529, as applicable, for explanations of the degrees of protection provided by different types of enclosure.

Preventing Electrostatic Discharge



ATTENTION: This equipment is sensitive to electrostatic discharge, which can cause internal damage and affect normal operation. Follow these guidelines when you handle this equipment:

- Touch a grounded object to discharge potential static.
 - Wear an approved grounding wriststrap.
 - Do not touch connectors or pins on component boards.
 - Do not touch circuit components inside the equipment.
 - Use a static-safe workstation, if available.
 - Store the equipment in appropriate static-safe packaging when not in use.
-

About the Module

The ArmorPOINT™ I/O family consists of modular I/O modules. The sealed IP67 housing of these modules requires no enclosure. Note that environmental requirements other than IP67 may require an additional appropriate housing. I/O connectors are sealed M12 (micro) style. The mounting base ships with the module. The 1738-IR2M12 module is shown here.

ArmorPOINT RTD and Thermocouple Input Module

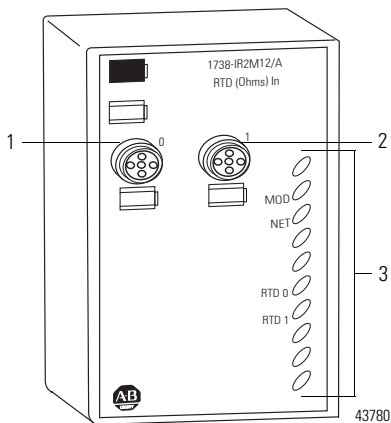

	Description		Description
1	Connector M12-A	3	LED indicators
2	Connector M12-B		

Mount the I/O Base

Mount the I/O base on a wall or panel, using the screw holes provided in the base.

IMPORTANT The module must be mounted on a grounded metal mounting plate or other conductive surface.

Mounting Diagram for ArmorPOINT Base with Adapter

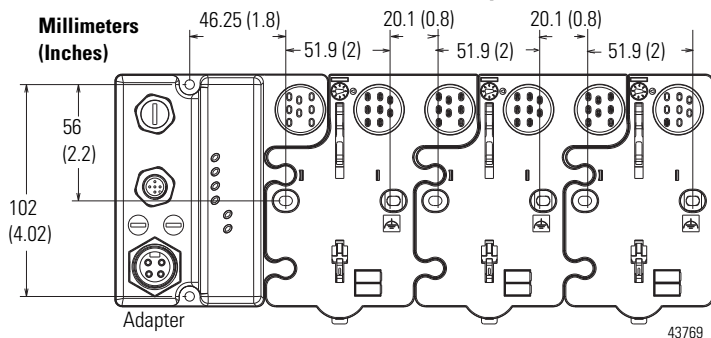

Follow the instructions to install the mounting base.

1. Lay out the required points as shown above in the drilling dimension diagram.
2. Drill the necessary holes for M4 (#8) machine or self-tapping screws.
3. Mount the base using M4 (#8) screws.
4. Ground the system using the ground lug connection. The ground lug connection is also a mounting hole.

Mounting Base

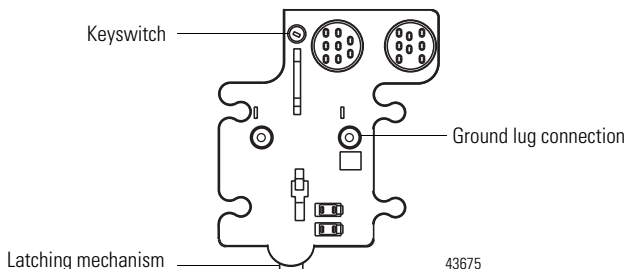

Install the Module

Follow the instructions to install the ArmorPOINT input module.

1. Using a bladed screwdriver, rotate the keyswitch on the mounting base clockwise until the number 6 aligns with the notch in the base.
2. Position the module vertically above the mounting base. The module bridges two bases.

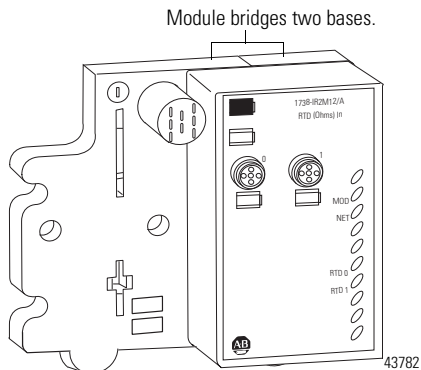

3. Push the module down until it engages the latching mechanism. You hear a clicking sound when the module is properly engaged. The locking mechanism locks the module to the base.

Remove the Module from the Mounting Base

Follow the instructions to remove the module from the mounting base.

1. Insert a flat blade screwdriver into the slot of the orange latching mechanism.
2. Push the screwdriver toward the I/O module to disengage the latch. The module lifts up off the base.
3. Pull the module off the base.

Wire the Module

Follow the wiring instructions for the ArmorPOINT input modules.

1738-IR2M12

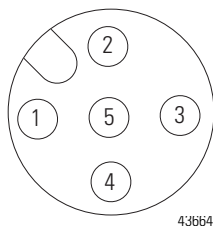

(View into connector)

- Pin 1 No connect
- Pin 2 Input 0A (M12-A)
Input 1A (M12-B)
- Pin 3 Input 0C (M12-A)
Input 1C (M12-B)
- Pin 4 Input 0B (M12-A)
Input 1B (M12-B)
- Pin 5 No connect

1738-IT2IM12

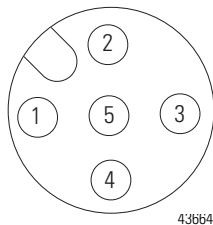

(View into connector)

- Pin 1 CJC +
- Pin 2 TC 0 + (M12-A)
TC 1 + (M12-B)
- Pin 3 CJC -
- Pin 4 TC 0 - (M12-A)
TC 1 - (M12-B)
- Pin 5 No connect

IMPORTANT Analog modules have earth grounded metal rings. This should be considered when choosing shielded cables and grounding techniques.



ATTENTION: Make sure all connectors and caps are securely tightened to properly seal the connections against leaks and maintain IP67 requirements.

Communicate with the Module

I/O messages are sent to (consumed) and received from (produced) the ArmorPOINT I/O modules. These messages are mapped onto the processor's memory. The ArmorPOINT RTD I/O input module produces 6 Bytes of input data (scanner Rx – status) and fault status data. The ArmorPOINT thermocouple I/O input module produces 8 Bytes of input data (scanner Rx – status) and fault status data. They do not consume I/O data (scanner Tx).

Default Data Map – 1738-IR2M12

Message size: 6 Bytes

	15	14	13	12	11	10	09	08	07	06	05	04	03	02	01	00
Produces (scanner Rx)	Input channel 0 high byte								Input channel 0 low byte							
	Input channel 1 high byte								Input channel 1 low byte							
	Status byte for channel 1								Status byte for channel 0							
	OR	UR	HHA	LLA	HA	LA	CM	CF	OR	UR	HHA	LLA	HA	LA	CM	CF
Consumes (scanner Tx)	No consumed data															

Where:

- OR = Overage; 0 = No error, 1 = Fault
- UR = Underrange; 0 = No error, 1 = Fault
- HHA = High/High Alarm; 0 = No error, 1 = Fault
- LLA = Low/Low Alarm; 0 = No error, 1 = Fault
- HA = High Alarm; 0 = No error, 1 = Fault
- LA = Low Alarm; 0 = No error, 1 = Fault
- CM = Calibration Mode; 0 = Normal, 1 = Calibration mode
- CF = Channel Fault Status; 0 = No error, 1 = Fault

Default Data Map – 1738-IT2IM12

Message size: 6 Bytes

	15	14	13	12	11	10	09	08	07	06	05	04	03	02	01	00
Produces (scanner Rx)	Input channel 0 high byte								Input channel 0 low byte							
	Input channel 1 high byte								Input channel 1 low byte							
	Status byte for channel 1								Status byte for channel 0							
	OR	UR	HHA	LLA	HA	LA	CM	CF	OR	UR	HHA	LLA	HA	LA	CM	CF
	OR	UR	Cold junction temperature (Selectable channel 0, channel 1, or average of both channels 0 and 1)													
Consumes (scanner Tx)	No consumed data															

Where:

- OR = Overage; 0 = No error, 1 = Fault
- UR = Underrange; 0 = No error, 1 = Fault
- HHA = High/High Alarm; 0 = No error, 1 = Fault
- LLA = Low/Low Alarm; 0 = No error, 1 = Fault
- HA = High Alarm; 0 = No error, 1 = Fault
- LA = Low Alarm; 0 = No error, 1 = Fault
- CM = Calibration Mode; 0 = Normal, 1 = Calibration mode
- CF = Channel Fault Status; 0 = No error, 1 = Fault

Interpret Status Indicators

This module has the following indicators:

- Adapter, DeviceNet and POINTBus status indicators
- System and Adapter power indicators
- Individual I/O status indicators for inputs and outputs

1738-IR2M12

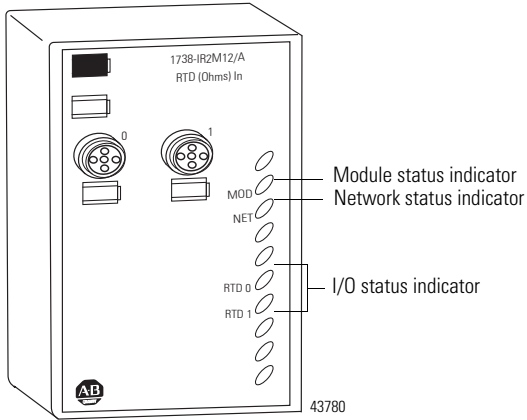

Indicator Status for Modules

	Status	Description
Module status	Off	No power applied to device.
	Green	Device operating normally.
	Flashing green	Device needs commissioning due to missing, incomplete, or incorrect configuration.
	Flashing red	Recoverable fault.
	Red	Unrecoverable fault – may require device replacement.
	Flashing red/green	Device is in self-test.

Indicator Status for Modules

	Status	Description
Network status	Off	Device is not online: - Device has not completed dup_MAC-id test. - Device not powered – check module status indicator.
	Flashing green	Device is online but has no connections in the established state.
	Green	Device is online and has connections in the established state.
	Flashing red	One or more I/O connections are in timed-out state.
	Red	Critical link failure – failed communication device. Device detected error that prevents it from communicating on the network. Possible duplicate MAC ID or baud rate mismatch.
	Flashing red/green	Communication faulted device – the device has detected a network access error and is in communication faulted state. Device has received and accepted an Identity Communication Faulted Request – long protocol message.
I/O status	Off	Module in CAL mode.
	Solid green	Normal (channel scanning inputs).
	Flashing green	Channel being calibrated.
	Solid red	Major channel fault.
	Flashing red	Channel at end of range (over or under).

Specifications

ArmorPOINT RTD and Thermocouple Input Modules – 1738-IR2M12, 1738-IT2IM12

Attribute	Value		
Inputs per module	1738-IR2M12 – 2 single-ended, nonisolated 1738-IT2IM12 – 2 differential, individually isolated		
Resolution	1738-IR2M12 – 16 bits, 9.5 mV/cnt, 0.03 °C/cnt (Pt385 @ 25 °) 1738-IT2IM12 – 15 bits plus sign, 2.5 mV/cnt		
Thermocouple type (and resolution average over span)	1738-IT2IM12 only		
	Sensor	Range	Resolution (average over span)
	Type B	30...1820 °C	3 counts/°C
	Type C	0...2315 °C	6 counts/°C
	Type E	-270...1000 °C	24 counts/°C
	Type J	-210...1200 °C	21 counts/°C
	Type K	-270...1372 °C	13 counts/°C
	Type N	-270...1300 °C	11 counts/°C
	Type R	-50...1768.1 °C	4 counts/°C
	Type S	-50...1768.1 °C	4 counts/°C
Type T	-270...400 °C	15 counts/°C	
RTD sensors supported	1738-IR2M12 only 100 ΩPt α = 0.00385 Euro (-200...870 °C) 200 ΩPt α = 0.00385 Euro (-200...630 °C) 100 ΩPt α = 0.003916 U.S. (-200...630 °C) 200 ΩPt α = 0.003916 U.S. (-200...630 °C) 10 ΩCu α = 0.00427 (-200...260 °C) 100 ΩNi α = 0.00618 (-60...250 °C) 120 ΩNi α = 0.00672 (-60...250 °C) 120 ΩNi α = 0.00618 (-60...250 °C)		
Cold junction compensation range	1738-IT2IM12 – 0...70 °C		
Input range	1738-IR2M12 – 0...600 Ω 1738-IT2IM12 – ±75 mV		
Absolute accuracy ⁽¹⁾	0.1% full scale @ 25 °C		
Accuracy drift w/temp	30 ppm/°C		

**ArmorPOINT RTD and Thermocouple Input Modules –
1738-IR2M12, 1738-IT2IM12**

Attribute	Value																				
Input update rate (per module)	<table border="1"> <thead> <tr> <th>1738-IR2M12</th> <th>1738-IT2IM12</th> </tr> </thead> <tbody> <tr> <td>40 ms @ Notch = 50 Hz</td> <td>20 ms @ Notch = 50 Hz</td> </tr> <tr> <td>33 ms @ Notch = 60 Hz (default)</td> <td>17 ms @ Notch = 60 Hz (default)</td> </tr> <tr> <td>20 ms @ Notch = 100 Hz</td> <td>10 ms @ Notch = 100 Hz</td> </tr> <tr> <td>17 ms @ Notch = 120 Hz</td> <td>8 ms @ Notch = 120 Hz</td> </tr> <tr> <td>10 ms @ Notch = 200 Hz</td> <td>5 ms @ Notch = 200 Hz</td> </tr> <tr> <td>8 ms @ Notch = 240 Hz</td> <td>4 ms @ Notch = 240 Hz</td> </tr> <tr> <td>7 ms @ Notch = 300 Hz</td> <td>3 ms @ Notch = 300 Hz</td> </tr> <tr> <td>5 ms @ Notch = 400 Hz</td> <td>3 ms @ Notch = 400 Hz</td> </tr> <tr> <td>4 ms @ Notch = 480 Hz</td> <td>2 ms @ Notch = 480 Hz</td> </tr> </tbody> </table>	1738-IR2M12	1738-IT2IM12	40 ms @ Notch = 50 Hz	20 ms @ Notch = 50 Hz	33 ms @ Notch = 60 Hz (default)	17 ms @ Notch = 60 Hz (default)	20 ms @ Notch = 100 Hz	10 ms @ Notch = 100 Hz	17 ms @ Notch = 120 Hz	8 ms @ Notch = 120 Hz	10 ms @ Notch = 200 Hz	5 ms @ Notch = 200 Hz	8 ms @ Notch = 240 Hz	4 ms @ Notch = 240 Hz	7 ms @ Notch = 300 Hz	3 ms @ Notch = 300 Hz	5 ms @ Notch = 400 Hz	3 ms @ Notch = 400 Hz	4 ms @ Notch = 480 Hz	2 ms @ Notch = 480 Hz
1738-IR2M12	1738-IT2IM12																				
40 ms @ Notch = 50 Hz	20 ms @ Notch = 50 Hz																				
33 ms @ Notch = 60 Hz (default)	17 ms @ Notch = 60 Hz (default)																				
20 ms @ Notch = 100 Hz	10 ms @ Notch = 100 Hz																				
17 ms @ Notch = 120 Hz	8 ms @ Notch = 120 Hz																				
10 ms @ Notch = 200 Hz	5 ms @ Notch = 200 Hz																				
8 ms @ Notch = 240 Hz	4 ms @ Notch = 240 Hz																				
7 ms @ Notch = 300 Hz	3 ms @ Notch = 300 Hz																				
5 ms @ Notch = 400 Hz	3 ms @ Notch = 400 Hz																				
4 ms @ Notch = 480 Hz	2 ms @ Notch = 480 Hz																				
Step response (per channel)	60 ms @ Notch = 50 Hz 50 ms @ Notch = 60 Hz 30 ms @ Notch = 100 Hz 25 ms @ Notch = 120 Hz 15 ms @ Notch = 200 Hz 13 ms @ Notch = 240 Hz 10 ms @ Notch = 300 Hz 8 ms @ Notch = 400 Hz 6 ms @ Notch = 480 Hz																				
Input resistance	1738-IT2IM12 only – 1 M Ω																				
Input impedance	1738-IT2IM12 only – 100 K Ω																				
Conversion type	Delta Sigma																				
Common mode rejection ratio	120 dB																				
Normal mode rejection ratio	100 dB -3 db Notch filter 13.1 Hz @ Notch = 50 Hz 15.7 Hz @ Notch = 60 Hz 26.2 Hz @ Notch = 100 Hz 31.4 Hz @ Notch = 120 Hz 52.4 Hz @ Notch = 200 Hz 62.9 Hz @ Notch = 240 Hz 78.6 Hz @ Notch = 300 Hz 104.8 Hz @ Notch = 400 Hz 125.7 Hz @ Notch = 380 Hz																				
Data format	Signed integer																				
Maximum overload	1738-IR2M12 – No input protection 1738-IT2IM12 – Input not overvoltage protected																				

⁽¹⁾ Includes offset, gain, non-linearity and repeatability error terms

14 ArmorPOINT RTD and Thermocouple Input Modules

General Specifications

Attribute	Value
Mounting base screw torque	M4 (#8) screw, 0.85 Nm (7.5 lb-in.) in aluminum, 1.8 Nm (16 lb-in.) in steel
Calibration	Factory-calibrated
POINTBus current	1738-IR2 – 220 mA @ 5V DC 1738-IT2I – 175 mA @ 5V DC
Power dissipation, max	1.0 W
Thermal dissipation, max	3.3 BTU/hr
Isolation voltage	Tested at 50V rms (1738-IT2I has isolation between individual channels)
Dielectric test	1000V rms flash for 1s
External DC power	No external power required
LED indicators	1 green/red – module status indicator, logic side 1 green/red – network status indicator, logic side 2 green/red – input status indicators, logic side
Dimensions, HxWxD	31.75 x 66.80 x 107.95 mm (1.25 x 2.63 x 4.25 in.)
Weight	0.289 kg (0.637 lb)
Enclosure type rating	Meets IP65/66/67 (when marked)
Wiring category ⁽¹⁾	1 – on signal ports
Keyswitch position	6

⁽¹⁾ Use this Conductor Category information for planning conductor routing. Refer to Industrial Automation Wiring and Grounding Guidelines, publication [1770-4.1](#).

Environmental Specifications

Attribute	Value
Temperature, operating	IEC 60068-2-1 (Test Ad, Operating Cold), IEC 60068-2-2 (Test Bd, Operating Dry Heat), IEC 60068-2-14 (Test Nb, Operating Thermal Shock): -20...60 °C (-4...140 °F)
Temperature, storage	IEC 60068-2-1 (Test Ab, Unpackaged Nonoperating Cold), IEC 60068-2-2 (Test Bb, Unpackaged Nonoperating Dry Heat), -40...85 °C (-40...185 °F)
Relative humidity	IEC 60068-2-30 (Test Db, Unpackaged Nonoperating Damp Heat): 5...95% noncondensing

Environmental Specifications

Attribute	Value
Vibration	IEC60068-2-6 (Test Fc, Operating): 5 g @ 10...500 Hz
Shock, operating	IEC60068-2-27 (Test Ea, Unpackaged Shock): 30 g
Shock, nonoperating	IEC60068-2-27 (Test Ea, Unpackaged Shock): 50 g
Emissions	Emissions CISPR 11: Group 1, Class A
ESD immunity	IEC 61000-4-2: 6 kV contact discharges 8 kV air discharges
Radiated RF immunity	IEC 61000-4-3: 10V/m with 1 kHz sine-wave 80% AM @ 30 MHz...1000 MHz 10V/m with 200 Hz 50% pulse 100% AM @ 900 Mhz
EFT/B immunity	IEC 61000-4-4: ±3 kV @ 5 kHz on signal ports
Surge transient immunity	IEC 61000-4-5: ±2 kV line-earth(CM) on shielded ports
Conducted RF immunity	IEC 61000-4-6: 10Vrms with 1kHz sine-wave 80% AM @ 150 kHz...80 MHz

Certifications

Certification (when product is marked) ⁽¹⁾	Value
c-UL-us	UL-listed Industrial Control Equipment, certified for US and Canada
CE	European Union 89/336/EEC EMC Directive, compliant with: EN 61000-6-4; Industrial Emissions EN 50082-2; Industrial Immunity EN 61326; Meas./Control/Lab., Industrial Requirements EN 61000-6-2; Industrial Immunity
C-Tick	Australian Radiocommunications Act, compliant with: AS/NZS CISPR 11; Industrial Emissions

⁽¹⁾ See the Product Certification link at <http://www.ab.com> for Declaration of Conformity, Certificates, and other certification details.

Rockwell Automation Support

Rockwell Automation provides technical information on the Web to assist you in using its products. At <http://www.rockwellautomation.com/support/>, you can find technical manuals, a knowledge base of FAQs, technical and application notes, sample code and links to software service packs, and a MySupport feature that you can customize to make the best use of these tools.

For an additional level of technical phone support for installation, configuration and troubleshooting, we offer TechConnect support programs. For more information, contact your local distributor or Rockwell Automation representative, or visit <http://www.rockwellautomation.com/support/>.

Installation Assistance

If you experience a problem within the first 24 hours of installation, please review the information that's contained in this manual. You can also contact a special Customer Support number for initial help in getting your product up and running.

United States or Canada	1.440.646.3434
Outside United States or Canada	Use the Worldwide Locator at http://www.rockwellautomation.com/support/americas/phone_en.html , or contact your local Rockwell Automation representative.

New Product Satisfaction Return

Rockwell Automation tests all of its products to ensure that they are fully operational when shipped from the manufacturing facility. However, if your product is not functioning and needs to be returned, follow these procedures.

United States	Contact your distributor. You must provide a Customer Support case number (call the phone number above to obtain one) to your distributor to complete the return process.
Outside United States	Please contact your local Rockwell Automation representative for the return procedure.

Documentation Feedback

Your comments will help us serve your documentation needs better. If you have any suggestions on how to improve this document, complete this form, publication [RA-DU002](#), available at <http://www.rockwellautomation.com/literature/>.

Allan-Bradley, Rockwell Automation, ArmorPOINT, and TechConnect are trademarks of Rockwell Automation, Inc.

Trademarks not belonging to Rockwell Automation are property of their respective companies.

Rockwell Otomasyon Ticaret A.Ş., Kar Plaza İş Merkezi E Blok Kat:6 34752 İçerenköy, İstanbul, Tel: +90 (216) 5698400

www.rockwellautomation.com

Power, Control and Information Solutions Headquarters

Americas: Rockwell Automation, 1201 South Second Street, Milwaukee, WI 53204-2496 USA, Tel: (1) 414.382.2000, Fax: (1) 414.382.4444
Europe/Middle East/Africa: Rockwell Automation, Voorlaan/Boulevard du Souverain 36, 1170 Brussels, Belgium, Tel: (32) 2 663 0600, Fax: (32) 2 663 0640
Asia Pacific: Rockwell Automation, Level 14, Core F, Cyberport 3, 100 Cyberport Road, Hong Kong, Tel: (852) 2887 4788, Fax: (852) 2508 1846

Publication 1738-IN005B-EN-E - January 2013

Supersedes Publication 1738-IN005A-EN-E - June 2004

Copyright © 2013 Rockwell Automation, Inc. All rights reserved.