

# Installation Instructions

Original Instructions



**Allen-Bradley**

by ROCKWELL AUTOMATION

## ArmorBlock I/O 8 Channel IO-Link Master Module

Catalog Number 1732E-8IOLM12R

Topic	Page
Summary of Changes	1
Additional Resources	3
About the Module	3
Install the Module	5
Mount the Module	5
Connect the I/O, Network, and Auxiliary Cables to the Module	7
Configure the Module	8
Interpret LED Indicators	9
Specifications	10

### Summary of Changes

This publication contains the following new or updated information. This list includes substantive updates only and is not intended to reflect all changes. Translated versions are not always available for each revision.

Topic	Page
Corrected module dimensions	6
Updated cordset catalog reference	8



**ATTENTION:** Read this document and the documents listed in the Additional Resources section about installation, configuration and operation of this equipment before you install, configure, operate or maintain this product. Users are required to familiarize themselves with installation and wiring instructions in addition to requirements of all applicable codes, laws, and standards.

Activities including installation, adjustments, putting into service, use, assembly, disassembly, and maintenance are required to be carried out by suitably trained personnel in accordance with applicable code of practice. If this equipment is used in a manner not specified by the manufacturer, the protection provided by the equipment may be impaired.

**注意:** 在安装、配置、操作和维护本产品前，请阅读本文档以及“其他资源”部分列出的有关设备安装、配置和操作的相应文档。除了所有适用规范、法律和标准的相关要求之外，用户还必须熟悉安装和接线说明。

安装、调整、投运、使用、组装、拆卸和维护等各项操作必须由经过适当训练的专业人员按照适用的操作规范实施。如果未按照制造商指定的方式使用该设备，则可能会损害设备提供的保护。

**ATENCIÓN:** Antes de instalar, configurar, poner en funcionamiento o realizar el mantenimiento de este producto, lea este documento y los documentos listados en la sección Recursos adicionales acerca de la instalación, configuración y operación de este equipo. Los usuarios deben familiarizarse con las instrucciones de instalación y cableado y con los requisitos de todos los códigos, leyes y estándares vigentes.

El personal debidamente capacitado debe realizar las actividades relacionadas a la instalación, ajustes, puesta en servicio, uso, ensamblaje, desensamblaje y mantenimiento de conformidad con el código de práctica aplicable. Si este equipo se usa de una manera no especificada por el fabricante, la protección provista por el equipo puede resultar afectada.

**ATENÇÃO:** Leia este e os demais documentos sobre instalação, configuração e operação do equipamento que estão na seção Recursos adicionais antes de instalar, configurar, operar ou manter este produto. Os usuários devem se familiarizar com as instruções de instalação e fiação além das especificações para todos os códigos, leis e normas aplicáveis.

É necessário que as atividades, incluindo instalação, ajustes, colocação em serviço, utilização, montagem, desmontagem e manutenção sejam realizadas por pessoal qualificado e especializado, de acordo com o código de prática aplicável.

Caso este equipamento seja utilizado de maneira não estabelecida pelo fabricante, a proteção fornecida pelo equipamento pode ficar prejudicada.

**ВНИМАНИЕ:** Перед тем как устанавливать, настраивать, эксплуатировать или обслуживать данное оборудование, прочитайте этот документ и документы, перечисленные в разделе «Дополнительные ресурсы». В этих документах изложены сведения об установке, настройке и эксплуатации данного оборудования. Пользователи обязаны ознакомиться с инструкциями по установке и прокладке соединений, а также с требованиями всех применимых норм, законов и стандартов.

Все действия, включая установку, наладку, ввод в эксплуатацию, использование, сборку, разборку и техническое обслуживание, должны выполняться обученным персоналом в соответствии с применимыми нормами и правилами.

Если оборудование используется не предусмотренным производителем образом, защита оборудования может быть нарушена.

**注意:** 本製品を設置、構成、稼働または保守する前に、本書および本機器の設置、設定、操作についての参考資料の該当箇所に記載されている文書に目を通してください。ユーザーは、すべての該当する条例、法律、規格の要件に加えて、設置および配線の手順に習熟している必要があります。

設置調整、運転の開始、使用、組立て、解体、保守を含む諸作業は、該当する実施規則に従って訓練を受けた適切な作業員が実行する必要があります。本機器が製造メーカーにより指定されていない方法で使用されている場合、機器により提供されている保護が損なわれる恐れがあります。

**ACHTUNG:** Lesen Sie dieses Dokument und die im Abschnitt „Weitere Informationen“ aufgeführten Dokumente, die Informationen zu Installation, Konfiguration und Bedienung dieses Produkts enthalten, bevor Sie dieses Produkt installieren, konfigurieren, bedienen oder warten. Anwender müssen sich neben den Bestimmungen aller anwendbaren Vorschriften, Gesetze und Normen zusätzlich mit den Installations- und Verdrahtungsanweisungen vertraut machen.

Arbeiten im Rahmen der Installation, Anpassung, Inbetriebnahme, Verwendung, Montage, Demontage oder Instandhaltung dürfen nur durch ausreichend geschulte Mitarbeiter und in Übereinstimmung mit den anwendbaren Ausführungsvorschriften vorgenommen werden.

Wenn das Gerät in einer Weise verwendet wird, die vom Hersteller nicht vorgesehen ist, kann die Schutzfunktion beeinträchtigt sein.

**ATTENTION:** Lisez ce document et les documents listés dans la section Ressources complémentaires relatifs à l'installation, la configuration et le fonctionnement de cet équipement avant d'installer, configurer, utiliser ou entretenir ce produit. Les utilisateurs doivent se familiariser avec les instructions d'installation et de câblage en plus des exigences relatives aux codes, lois et normes en vigueur. Les activités relatives à l'installation, le réglage, la mise en service, l'utilisation, l'assemblage, le démontage et l'entretien doivent être réalisées par des personnes formées selon le code de pratique en vigueur.

Si cet équipement est utilisé d'une façon qui n'a pas été définie par le fabricant, la protection fournie par l'équipement peut être compromise.

**주의:** 본 제품 설치, 설정, 작동 또는 유지 보수하기 전에 본 문서를 포함하여 설치, 설정 및 작동에 관한 참고 자료 섹션의 문서들을 반드시 읽고 숙지하십시오. 사용자는 모든 관련 규정, 법규 및 표준에서 요구하는 사항에 대해 반드시 설치 및 배선 지침을 숙지해야 합니다.

설치, 조정, 가동, 조립, 분해, 유지보수 등 모든 작업은 관련 규정에 따라 적절한 교육을 받은 사용자를 통해서만 수행해야 합니다.

본 장비를 제조사가 명시하지 않은 방법으로 사용하면 장비의 보호 기능이 손상될 수 있습니다.

**ATTENZIONE:** Prima di installare, configurare ed utilizzare il prodotto, o effettuare interventi di manutenzione su di esso, leggere il presente documento ed i documenti elencati nella sezione "Altre risorse", riguardanti l'installazione, la configurazione ed il funzionamento dell'apparecchiatura. Gli utenti devono leggere e comprendere le istruzioni di installazione e cablaggio, oltre ai requisiti previsti dalle leggi, codici e standard applicabili.

Le attività come installazione, regolazioni, utilizzo, assemblaggio, disassemblaggio e manutenzione devono essere svolte da personale adeguatamente addestrato, nel rispetto delle procedure previste. Qualora l'apparecchio venga utilizzato con modalità diverse da quanto previsto dal produttore, la sua funzione di protezione potrebbe venire compromessa.

**DIKKAT:** Bu ürünün kurulumu, yapılandırılması, işletilmesi veya bakımı öncesinde bu dokümanı ve bu ekipmanın kurulumu, yapılandırılması ve işletimi ile ilgili İlave Kaynaklar bölümünde yer listelenmiş dokümanları okuyun. Kullanıcılar yürürlükteki tüm yönetmelikler, yasalar ve standartların gereksinimlerine ek olarak kurulum ve kablolama talimatlarını da öğrenmek zorundadır.

Kurulum, ayarlama, hizmete alma, kullanma, parçaları birleştirme, parçaları sökme ve bakım gibi aktiviteler sadece uygun eğitimli almış kişiler tarafından yürürlükteki uygulama yönetmeliklerine uygun şekilde yapılabilir.

Bu ekipman üretici tarafından belirlenmiş amacın dışında kullanılırsa, ekipman tarafından sağlanan koruma bozulabilir.

**注意事項:** 在安装、設定、操作或維護本產品前，請先閱讀此文件以及列於“其他資源”章節中所有有關安裝、設定與操作此設備的文件。使用者必須熟悉安裝和配線指示，並符合所有法規、法律和標準要求。

包括安裝、調整、交付使用、使用、組裝、拆卸和維護等動作都必須交由已經過適當訓練的人員進行，以符合適用的實作法規。

如果將設備用於非製造商指定的用途時，可能會造成設備所提供的保護功能受損。

**POZOR:** Než začnete instalovat, konfigurovat či provozovat tento výrobek nebo provádět jeho údržbu, přečtěte si tento dokument a dokumenty uvedené v části Dodatečné zdroje ohledně instalace, konfigurace a provozu tohoto zařízení. Uživatelé se musejí vedle požadavků všech relevantních vyhlášek, zákonů a norem nutně seznámit také s pokyny pro instalaci a elektrické zapojení.

Činnosti zahrnující instalaci, nastavení, uvedení do provozu, užívání, montáž, demontáž a údržbu musí vykonávat vhodně proškolený personál v souladu s příslušnými prováděcími předpisy.

Pokud se toto zařízení používá způsobem neodpovídajícím specifikaci výrobce, může být narušena ochrana, kterou toto zařízení poskytuje.

**UWAGA:** Przed instalacją, konfiguracją, użytkowaniem lub konserwacją tego produktu należy przeczytać niniejszy dokument oraz wszystkie dokumenty wymienione w sekcji Dodatkowe źródła omawiające instalację, konfigurację i procedury użytkowania tego urządzenia. Użytkownicy mają obowiązek zapoznać się z instrukcjami dotyczącymi instalacji oraz oprzewodowania, jak również z obowiązującymi kodeksami, prawem i normami.

Działania obejmujące instalację, regulację, przekazanie do użytkowania, użytkowanie, montaż, demontaż oraz konserwację muszą być wykonywane przez odpowiednio przeszkolony personel zgodnie z obowiązującym kodeksem postępowania.

Jeśli urządzenie jest użytkowane w sposób inny niż określony przez producenta, zabezpieczenie zapewniane przez urządzenie może zostać ograniczone.

**OBBS!** Läs detta dokument samt dokumentet, som står listat i avsnittet Övriga resurser, om installation, konfiguration och drift av denna utrustning innan du installerar, konfigurerar eller börjar använda eller utföra underhållsarbete på produkten. Användare måste bekanta sig med instruktioner för installation och kabeldragning, förutom krav enligt gällande koder, lagar och standarder.

Åtgärder som installation, justering, service, användning, montering, demontering och underhållsarbete måste utföras av personal med lämplig utbildning enligt lämpligt bruk.

Om denna utrustning används på ett sätt som inte anges av tillverkaren kan det hända att utrustningens skyddsanordningar försätts ur funktion.

**LET OP:** Lees dit document en de documenten die genoemd worden in de paragraaf Aanvullende informatie over de installatie, configuratie en bediening van deze apparatuur voordat u dit product installeert, configureert, bedient of onderhoudt. Gebruikers moeten zich vertrouwd maken met de installatie en de bedravingsinstructies, naast de vereisten van alle toepasselijke regels, wetten en normen.

Activiteiten zoals het installeren, afstellen, in gebruik stellen, gebruiken, monteren, demonteren en het uitvoeren van onderhoud mogen uitsluitend worden uitgevoerd door hiervoor opgeleid personeel en in overeenstemming met de geldende praktijkregels.

Indien de apparatuur wordt gebruikt op een wijze die niet is gespecificeerd door de fabrikant, dan bestaat het gevaar dat de beveiliging van de apparatuur niet goed werkt.

## Environment and Enclosure



**ATTENTION:** This equipment is intended for use in overvoltage Category II applications (as defined in IEC 60664-1), at altitudes up to 2000 m (6562 ft) without derating.

This equipment is considered Group 1, Class A industrial equipment according to IEC/CISPR 11. Without appropriate precautions, there may be difficulties with electromagnetic compatibility in residential and other environments due to conducted and radiated disturbances.

This equipment is supplied as enclosed equipment. It should not require additional system enclosure when used in locations consistent with the equipment Enclosure Type Ratings. Subsequent sections of this publication may contain more information regarding specific enclosure type ratings, beyond what this product provides, that are required to comply with certain product safety certifications.

In addition to this publication, see:

- Industrial Automation Wiring and Grounding Guidelines, Rockwell Automation publication [1770-4.1](#), for additional install requirements.
- NEMA Standard 250 and IEC 60529, as applicable, for explanations of the degrees of protection provided by different types of enclosure.

## Preventing Electrostatic Discharge



**ATTENTION:** This equipment is sensitive to electrostatic discharge, which can cause internal damage and affect normal operation. Follow these guidelines when you handle this equipment:

- Touch a grounded object to discharge potential static.
- Wear an approved grounding wriststrap.
- Do not touch connectors or pins on component boards.
- Do not touch circuit components inside the equipment.
- Use a static-safe workstation, if available.
- Store the equipment in appropriate static-safe packaging when not in use.



**ATTENTION:** To comply with UL restrictions, this equipment and all connected I/O must be powered from a source compliant with the following: Safety Extra Low Voltage (SELV)



**ATTENTION:** To comply with CE Low Voltage Directive (LVD), this equipment and all connected I/O must be powered from a source compliant with the following: Safety Extra Low Voltage (SELV)

## Additional Resources

Resource	Description
ArmorBlock IO-Link Master Module Wiring Diagrams <a href="#">1732E-WD008</a>	Pinout guide wiring diagram for the ArmorBlock IO-Link Master module.
ArmorBlock 8 Channel IO-Link Master Module User Manual <a href="#">1732E-UM007</a>	A detailed description of module functionality, configuration, installation procedure and information on how to use the 1732E ArmorBlock EtherNet/IP.
Industrial Automation Wiring and Grounding Guidelines, publication <a href="#">1770-4.1</a> .	More information on proper wiring and grounding techniques.

If you would like a manual, you can:

- download a free electronic version from the Internet: [rok.auto/literature](http://rok.auto/literature)
- purchase a printed manual by contacting your local Allen-Bradley distributor or Rockwell Automation representative

## About the Module

The 1732E ArmorBlock® EtherNet/IP™ provides eight channels that can be individually configured as IO-Link master or as a standard digital I/O module. The IO-Link channel master module can be configured to fit any IO-Link and/or discrete application.

In IO-Link mode, the module supports eight channels for IO-Link master communication with IO-Link compatible devices. In standard digital I/O mode, the module supports eight channels of digital input or output. Standard digital input channels support IEC61131-2 type 1 input. Channels can also be disabled if not in use.

You must use this module with RSLogix 5000® or Studio 5000 Logix Designer® application, version 20 or later. Use this diagram to identify the external features of the module.

Module Identification

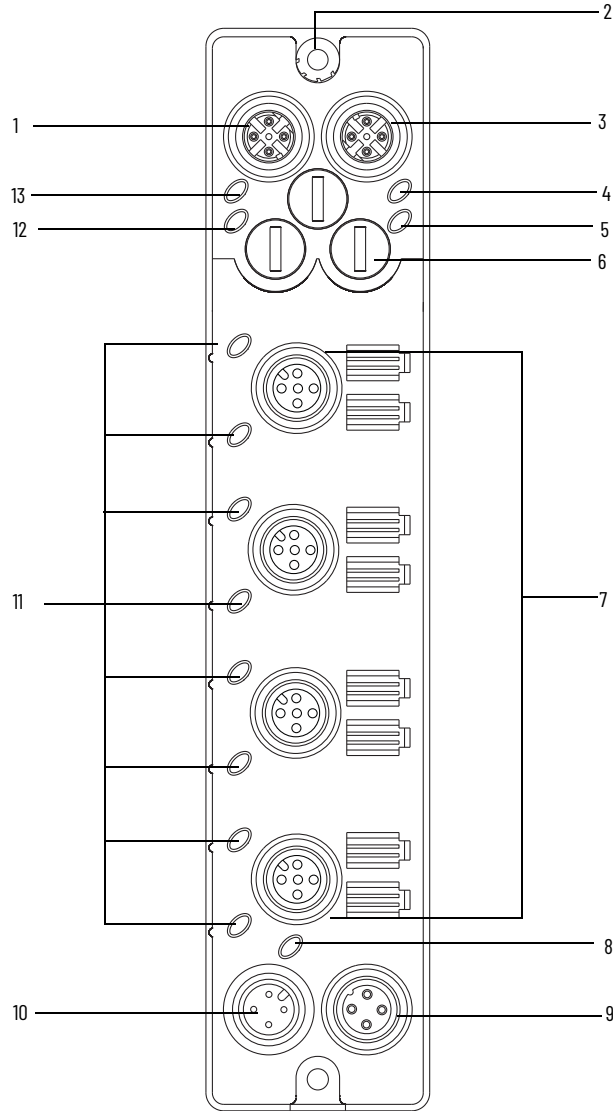

	Description		Description
1	EtherNet/IP D-code M12 connector	8	Auxiliary power indicator
2	Function earth <sup>(1)</sup>	9	Micro-style power out
3	EtherNet/IP D-code M12 connector	10	Micro-style power in
4	Link 2 status indicator	11	Channel I/O or digital I/O status indicators
5	Network status indicator	12	Module status indicator
6	Node address switches	13	Link 1 status indicator
7	Micro-style I/O connectors		

(1) Functional Earth grounds the I/O block's EtherNet/IP communication circuitry, which is designed to mitigate the effect of noise on the network. The device requires a solid earth ground connection, either through a metal screw to a grounded metal panel or through a wire. [See EtherNet/IP Connector on page 7](#) for connections.

## Install the Module

To install the module:

- Set the network address.
- Mount the module.
- Connect the I/O, Network, and Auxiliary cables to the module.

## Set the Network Address

The I/O block ships with the rotary switches set to 999 and DHCP enabled.

To change the network address, you can do one of the following:

- adjust the switch on the front of the module.
- use a Dynamic Host Configuration Protocol (DHCP) server, such as Rockwell Automation BootP/DHCP.
- retrieve the IP address from nonvolatile memory.

The I/O block reads the switches first to determine if the switches are set to a valid number. To set the network address:

1. Remove power.
2. Remove the switch dust caps.
3. Rotate the three (3) switches on the front of the module using a small blade screwdriver.
4. Line up the small notch on the switch with the number setting you wish to use. Valid settings range from 001...254.
5. Replace switch dust caps. Make sure not to over tighten.
6. Reapply power.

## Set Network Address

Example shows default node address set at 163.

**Note:** You need to remove the protective switch dust caps before you can adjust the address settings.

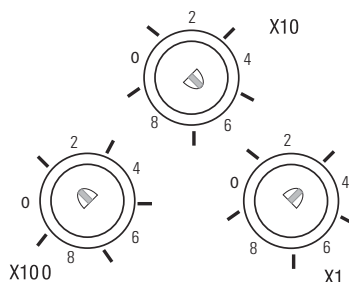

When the switches are set to a valid number, the I/O block's IP address is 192.168.1.xxx (where xxx represents the number set on the switches). The I/O block's subnet mask is 255.255.255.0 and the gateway address is set to 0.0.0.0. When the I/O block uses the network address set on the switches, the I/O block does not have a host name assigned to it or use any Domain Name Server.

If the switches are set to an invalid number (for example, 000 or a value greater than 254 excluding 888), the I/O block checks to see if DHCP is enabled. If DHCP is enabled, the I/O block asks for an address from a DHCP server. The DHCP server also assigns other Transport Control Protocol (TCP) parameters.

If DHCP is not enabled, the I/O block uses the IP address (along with other TCP configurable parameters) stored in nonvolatile memory.

## Mount the Module

Two sets of mounting holes are used to mount the module directly to a panel or machine. Mounting holes accommodate #8 (M4) pan head screws. The torque specification is 0.68 N•m (6 lb•in.).

## Product Dimensions

See the mounting dimensions illustration to help you mount the module.

### Module Dimensions

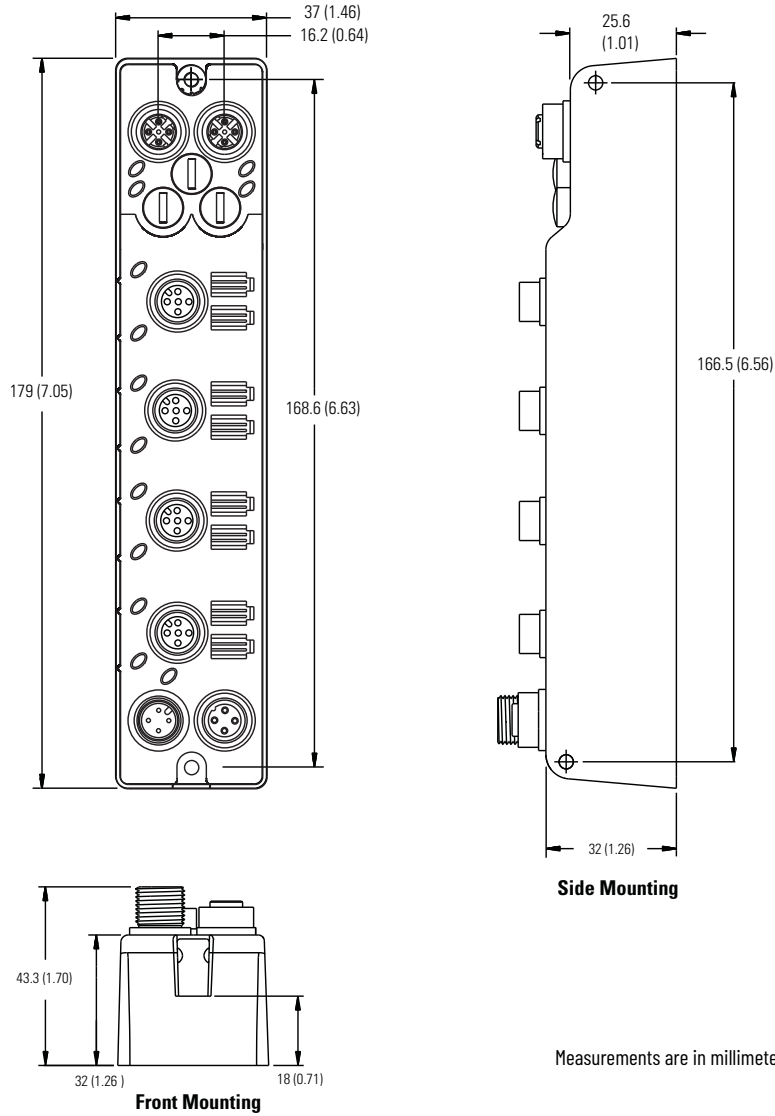

### Mount the Module in High Vibration Areas

If you mount the module in an area that is subject to shock or vibration, we recommend you use a flat and a lock washer to mount the module. Mount the flat and the lock washer as shown in the mounting illustration. Torque the mounting screws to 0.68 N•m (6 lb•in.).

### High Vibration Area Mounting

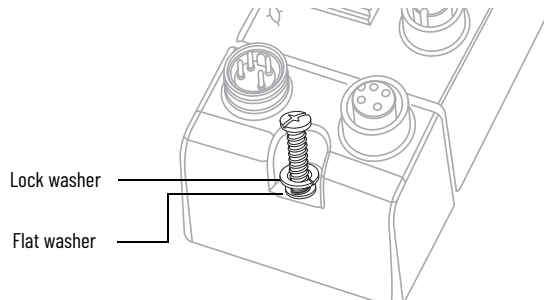

## Connect the I/O, Network, and Auxiliary Cables to the Module

The 1732E-8IOLM12R ArmorBlock EtherNet/IP module has a 5-pin micro-style I/O connectors. We provide caps to cover the unused connectors on your module. Connect the quick-disconnect cord sets you selected for your module to the appropriate ports.

### I/O Connectors

#### Micro-style 5-pin I/O Female Connector

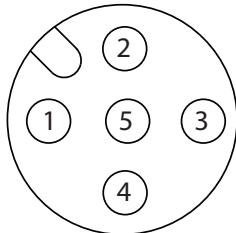

**(View into connector)**

- Pin 1 Sensor source voltage
- Pin 2 IO-Link, Input/output B
- Pin 3 Return
- Pin 4 IO-Link, Input/output A
- Pin 5 PE

### EtherNet/IP Connector

#### D-Code Micro Network Female Connector

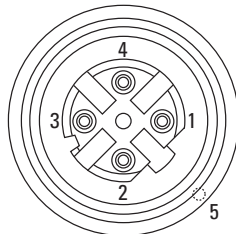

**(View into connector 1)**

- Pin 1 M12\_Tx+
- Pin 2 M12\_Rx+
- Pin 3 M12\_Tx-
- Pin 4 M12\_Rx-
- Pin 5 Connector shell shield GND

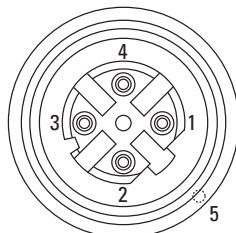

**(View into connector 2)**

- Pin 1 M12\_Rx+
- Pin 2 M12\_Tx+
- Pin 3 M12\_Rx-
- Pin 4 M12\_Tx-
- Pin 5 Connector shell shield GND

**IMPORTANT** Use the 1585D-M4DC-H: Polyamide small body unshielded mating connectors for the D-Code M12 female network connector. Note that the distance between the center of each Ethernet connector is 16.2 mm (refer to [Module Dimensions on page 6](#)). Rockwell Automation recommends the use of suitable cable based on this measurement. Some of the recommended cables are 1585D-M4TBJM-x and 1585D-M4TBDM-x for daisy chains.

**IMPORTANT** Use two twisted-pair CAT5E UTP or STP cables

D-Code M12 Pin	Wire Color	Signal	8-way Modular RJ45 Pin
1	White-orange	TX+	1
2	White-green	RX+	3
3	Orange	TX-	2
4	Green	RX-	6

## Configure the Module

See the illustration for configuration operations.

### Configure Operations

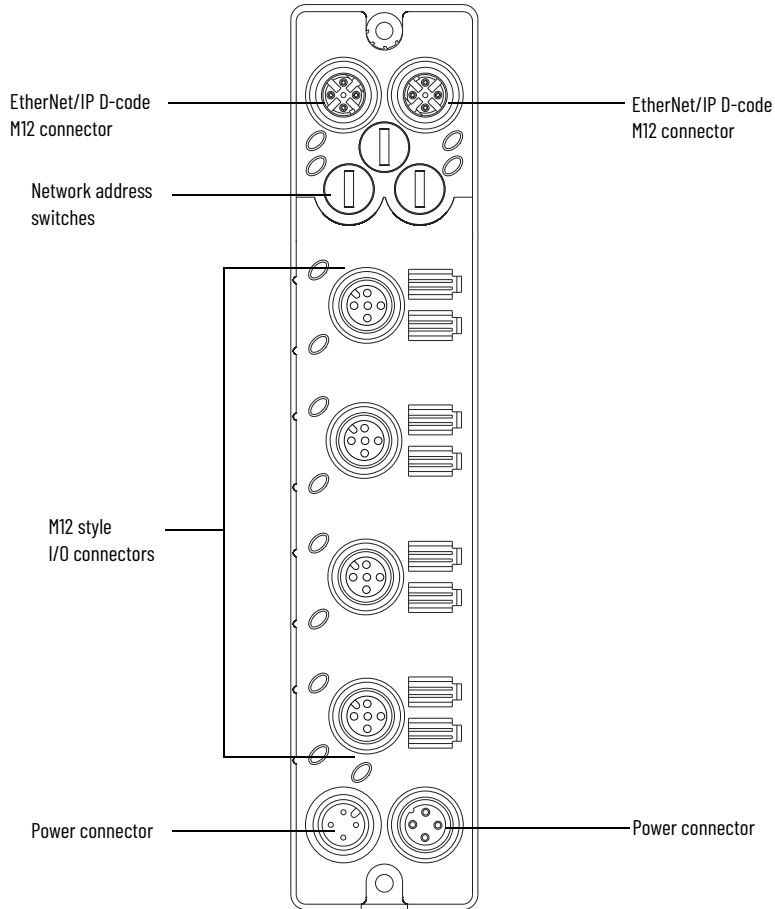

See Essential Components Selection Guide, publication [EC-CA100](#), for Rockwell Automation cable and cord set offerings or use the configuration tools available at [rok.auto/systemtools](http://rok.auto/systemtools).

### Auxiliary Power Connectors

Attach the micro-style 4-pin connector to the micro-style 4-pin receptacle as shown below.

### Auxiliary Power Micro-style 4-Pin Receptacles

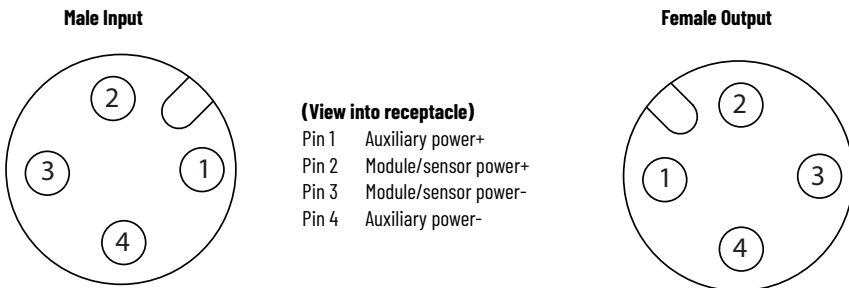

**IMPORTANT** The maximum current that any pin on the power connectors can carry is 4 A.

The power required by the module is based on a 4-pin micro-style connector system. The module receives its required power through the male connector on the left. A female connector on the right is also provided so that power can be daisy chained from module to module.



The module requires two 24V DC (nominal) supplies. These supplies are called the Module Power and the Auxiliary Power. The module power powers the microprocessor and Ethernet portions of the module. The Auxiliary Power provides power for the Digital Outputs, the Digital Inputs, and the Sensor Voltage.

Internally, the Module Power and Auxiliary Power are isolated from each other.

## Interpret LED Indicators

This module has the following indicators:

- Module, Network, and Link status indicators for EtherNet/IP
- Power status indicator
- Individual channel status indicators for inputs and outputs

### Status Indicators

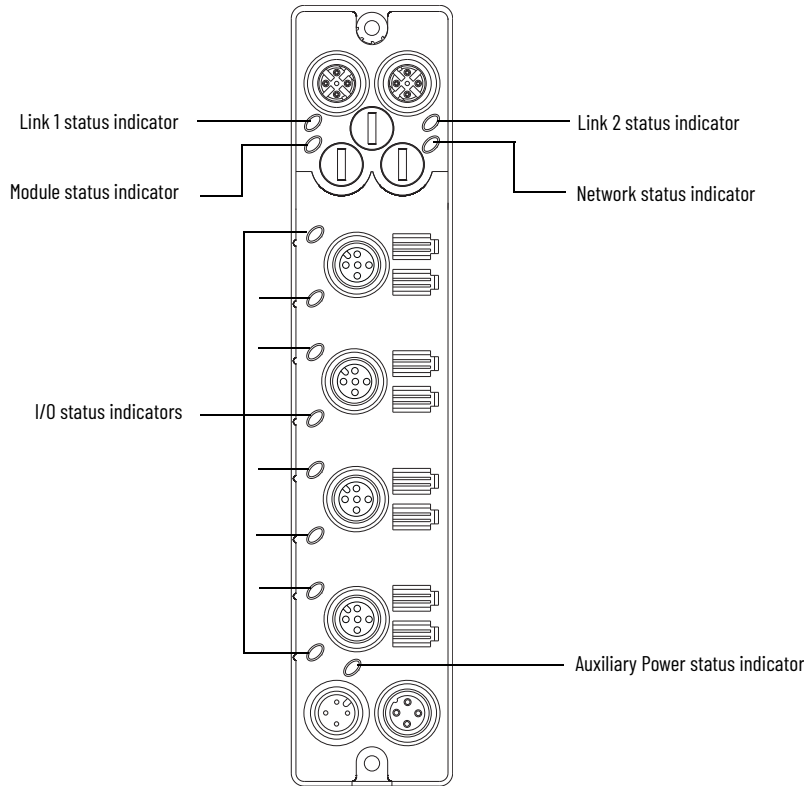

### Indicator Status for Module

Indicator	Status	Description
Module status	Off	No power applied to the device.
	Flashing green	The device has not been configured. If Master Sync Enable bit is set, and the device is not synchronized to a PTP master, the device is not configured.
	Green	Device operating normally.
	Red	Unrecoverable fault – may require device replacement.
Module status	Flashing red	One or more recoverable minor faults detected. Possible minor faults indicated are: <ul style="list-style-type: none"> <li>• The device is performing a firmware flash update.</li> <li>• The IO-Link stack is faulted.</li> <li>• IP address switches do not match configuration in use</li> <li>• The device has completed a reset to factory default request due to the switches being set to 888 at power-up, and a power cycle is required.</li> </ul>
	Flashing red/green	The module is performing POST (power on self test), which completes within 30 s.
Network status	Off	The device is not initialized or the module does not have an IP address.
	Flashing green	The device has an IP address, but no connections are established.
	Green	The device is online, has an IP address, and at least one connection is established.
	Flashing red	One or more connections have timed out.
	Red	The module has detected that its IP address is already in use.

### Indicator Status for Module

Indicator	Status	Description
Link status	Off	No link established.
	Green	Link established on indicated port at 100 Mbps.
	Flashing green	Link activity present on indicated port at 100 Mbps.
	Yellow	Link established on indicated port at 10 Mbps.
	Flashing yellow	Link activity present on indicated port at 10 Mbps.
Auxiliary power status	Off	No power to device or input not valid.
	Green	Power applied to device.

### Channel LED Indicator Status for Module

Indicator	Status	Mode	Description
Channel LED status	Off	Both	Output/input is in off state, is in IO-Link mode but is not energized.
	Yellow	Standard I/O	Output/input is in on state.
	Flashing green	IO-Link	Port startup or IO-Link device not found.
	Green	IO-Link	IO-Link enabled.
	Flashing red	IO-Link	IO-Link device connected to channel does not match configured electronic key.
	Red	Both	Output is shorted or overcurrent condition exists.

**IMPORTANT** The Module Status LED indicator will flash red and green for a maximum 30 s while the module completes its POST (power on self test).

## Specifications

### General Specifications

Attribute	Value
Number of inputs/outputs	8 Type 1 defined, sinking
Communication rate, Ethernet	10/100 Mbps, Full or half-duplex 100 meter per segment
Communication rate, IO-Link	4.8 kB; 38.4 kB; 230.4 kB
Voltage, power max	28.8V DC
Voltage, power min	20V DC
Current, Module Power, max per module	100 mA @ 24V DC
Current, Auxiliary Power, module only (no Digital Output loads, no Sensor Voltage Loads, and no power daisy-chain loads)	30 mA @ 24V DC
Current, Auxiliary Power, max per module (module plus Digital Output Loads, plus Sensor Voltage Loads, plus power daisy-chain loads)	4 A
Isolation voltage	50V (continuous), Basic Insulation Type, outputs and output power to Network, 50V Basic Insulation Type between the field network connections. 50V Basic Insulation Type between module power and output power. No isolation between individual I/Os or between I/Os and output power. No isolation between both network channels at the CPU/DLR power side.
Status indicators	Module status - red/green Network status - red/green Link status - green/yellow Power status - green I/O LED - yellow/red IO-Link LED - green/red
Dimensions, approx, HxWxD	179 x 37 x 27 mm (7.05 x 1.46 x 1.06 in.)
Pilot Duty Rating	DC-14
Weight approx	0.34 kg (0.75 lb)
Wiring category <sup>(1)</sup>	1 - on signal ports 1 - on power ports 1 - on communication ports
Enclosure type rating	Meets IP65/66/67/69K

(1) Use this Conductor Category information for planning conductor routing. See publication [1770-4.1](#), Industrial Automation Wiring and Grounding Guidelines.

**1732E ArmorBlock EtherNet/IP – Standard Digital Input**

Attribute	Value
On-state voltage min	15V DC
On-state current min	2.0 mA
Off-state voltage max	5V DC
Off-state current max	1.5 mA
Input delay time	Software configurable
Sensor Source Voltage (SSV) voltage min	1V
Sensor Source Voltage (SSV) available current, per channel max	500 mA
Sensor Source Voltage (SSV) available current, per connector max	1 A
Short circuit detection	Per I/O connector (two shared channels per I/O connector)

**1732E ArmorBlock EtherNet/IP – Standard Digital Output**

Attribute	Value
On-state voltage min	15V DC
On-state voltage max	28.8V DC
On-state voltage nom	24V DC
On-state current, per output max	250 mA
On-state current, total for all channels combined max	2 A (250 mA X 8 outputs)
Off-state current leakage, per output max	500 $\mu$ A
Surge current, per output max	0.3 A for 10 ms, repeatable every 3 seconds.
Short circuit detection	Per channel

**Environmental Specifications**

Attribute	Value
Temperature, operating	IEC 60068-2-1 (Test Ad, Operating Cold), IEC 60068-2-2 (Test Bd, Operating Dry Heat), IEC 60068-2-14 (Test Nb, Operating Thermal Shock): -20...+60 °C (-4...+140 °F)
Temperature, ambient rating (UL)	60 °C (140 °F)
Temperature, nonoperating	IEC 60068-2-1 (Test Ab, Unpackaged Nonoperating Cold), IEC 60068-2-2 (Test Bb, Unpackaged Nonoperating Dry Heat), IEC 60068-2-14 (Test Na, Unpackaged Nonoperating Thermal Shock): -40...+85 °C (-40...+185 °F)
Relative humidity	IEC 60068-2-30 (Test Db, Unpackaged Damp Heat): 5...95% noncondensing
Vibration	IEC 60068-2-6 (Test Fc, Operating): 5 g @ 10...500 Hz
Shock, operating	IEC 60068-2-27 (Test Ea, Unpackaged Shock): 30 g
Shock, nonoperating	IEC 60068-2-27 (Test Ea, Unpackaged Shock): 50 g
Emissions	CISPR 11 (IEC 61000-6-4): Class A
ESD immunity	IEC 61000-4-2: 6 kV contact discharges 8 kV air discharges
Radiated RF immunity	IEC 61000-4-3: 10V/m with 1 kHz sine-wave 80% AM from 80...1000 MHz 10V/m with 1 kHz sine-wave 80% AM from 1000...2000 MHz 10V/m with 200 Hz SQ-wave 100% Pulse modulated at 50% duty cycle @ 900 MHz Pulse 10V/m with 200 Hz 50% Pulse 100% AM @ 1890 MHz Pulse 10V/m with 1 kHz sine-wave 80% AM from 2000...2700 MHz

## Environmental Specifications

Attribute	Value
EFT/B immunity	IEC 61000-4-4: ±3 kV at 5 kHz on power ports ±3 kV at 5 kHz on signal ports
Surge transient immunity	IEC 61000-4-5: ±1 kV line-line(DM) and ±2 kV line-earth(CM) on power ports ±1 kV line-earth(CM) on signal ports ±2 kV line-earth(CM) on communication ports
Conducted RF immunity	IEC 61000-4-6: 10V rms with 1 kHz sine-wave 80% AM from 150 kHz...80 MHz

## Certifications

Certification (when product is marked) <sup>(1)</sup>	Value
c-UR-us	UL Recognized Component, certified for US and Canada. See UL File E322657.
CE	EMC Directive 2014/30/EU Directive, compliant with: EN 61326-1; Meas./Control/Lab., Industrial Requirements EN 61000-6-2; Industrial Immunity EN 61000-6-4; Industrial Emissions EN 61131-2; Programmable Controllers (Clause 8, Zone A & B)
RCM	Australian Radiocommunications Act, compliant with: AS/NZS CISPR11; Industrial Emissions.
KC	Korean Registration of Broadcasting and Communications Equipment, compliant with: Article 58-2 of Radio Waves Act, Clause 3
EtherNet/IP	ODVA conformance tested to EtherNet/IP specifications.

(1) See the Product Certification link at [rok.auto/certifications](http://rok.auto/certifications) for Declaration of Conformity, Certificates, and other certification details.

# Rockwell Automation Support

Use these resources to access support information.

<b>Technical Support Center</b>	Find help with how-to videos, FAQs, chat, user forums, and product notification updates.	<a href="http://rok.auto/support">rok.auto/support</a>
<b>Knowledgebase</b>	Access Knowledgebase articles.	<a href="http://rok.auto/knowledgebase">rok.auto/knowledgebase</a>
<b>Local Technical Support Phone Numbers</b>	Locate the telephone number for your country.	<a href="http://rok.auto/phonesupport">rok.auto/phonesupport</a>
<b>Literature Library</b>	Find installation instructions, manuals, brochures, and technical data publications.	<a href="http://rok.auto/literature">rok.auto/literature</a>
<b>Product Compatibility and Download Center (PCDC)</b>	Download firmware, associated files (such as AOP, EDS, and DTM), and access product release notes.	<a href="http://rok.auto/pcdc">rok.auto/pcdc</a>

## Documentation Feedback

Your comments help us serve your documentation needs better. If you have any suggestions on how to improve our content, complete the form at [rok.auto/docfeedback](http://rok.auto/docfeedback).

## Waste Electrical and Electronic Equipment (WEEE)







At the end of life, this equipment should be collected separately from any unsorted municipal waste.

Rockwell Automation maintains current product environmental compliance information on its website at [rok.auto/pec](http://rok.auto/pec).

Your comments help us serve your documentation needs better. If you have any suggestions on how to improve our content, complete the form at [rok.auto/docfeedback](http://rok.auto/docfeedback).

For technical support, visit [rok.auto/support](http://rok.auto/support).

Rockwell Otomasyon Ticaret A.Ş. Kar Plaza İş Merkezi E Blok Kat:6 34752 Çerenköy, İstanbul, Tel: +90 (216) 5698400 EEE Yönetmeliğine Uygundur

Connect with us.    

**rockwellautomation.com** — expanding **human possibility**<sup>™</sup>

AMERICAS: Rockwell Automation, 1201 South Second Street, Milwaukee, WI 53204-2496 USA, Tel: (1) 414.382.2000, Fax: (1) 414.382.4444

EUROPE/MIDDLE EAST/AFRICA: Rockwell Automation NV, Pegasus Park, De Kleetlaan 12a, 1831 Diegem, Belgium, Tel: (32) 2 663 0600, Fax: (32) 2 663 0640

ASIA PACIFIC: Rockwell Automation, Level 14, Core F, Cyberport 3, 100 Cyberport Road, Hong Kong, Tel: (852) 2887 4788, Fax: (852) 2508 1846

Allen-Bradley, ArmorBlock, expanding human possibility, FactoryTalk, RSLogix 5000, Rockwell Automation, Studio 5000 Logix Designer, and TechConnect are trademarks of Rockwell Automation, Inc.

EtherNet/IP is a trademark of ODVA, Inc.

Trademarks not belonging to Rockwell Automation are property of their respective companies.

Publication 1732E-IN001B-EN-E - July 2020 | Supersedes Publication 1732E-IN001A-EN-E-July 2016

Copyright © 2020 Rockwell Automation, Inc. All rights reserved.