

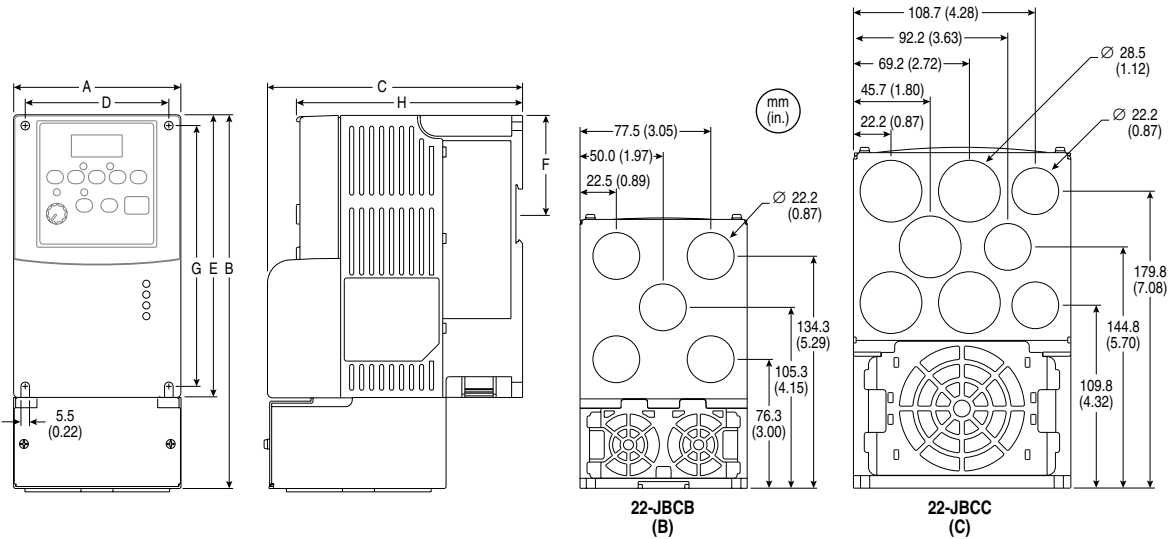

**Installation Instructions**  
**Installationsanleitung**  
**Installation**  
**Installazione**  
**Instalación**  
**Instructies**  
**Instalação**

**PowerFlex 40 IP 30/NEMA 1/UL Type 1 Conversion Kit for Communication Option (Series B)**  
**PowerFlex 40 Optionkits IP 30/NEMA 1/UL-Tipo 1 (Serie B)**  
**PowerFlex 40 Kit d'option IP 30/NEMA 1/UL type 1 (Série B)**  
**PowerFlex 40 Kit opzionale IP 30/NEMA 1/Tipo UL 1 (Serie B)**  
**PowerFlex 40 Conjunto opcional IP 30/NEMA 1/UL Tipo 1 (Serie B)**  
**PowerFlex 40 optie voor IP 30/NEMA 1/UL type 1 (Serie B)**  
**PowerFlex 40 Kit opcional IP 30/NEMA 1/UL Tipo 1 (Série B)**



	A	B	C	D	E	F	G	H
<b>22-JBCB (B)</b>	100 (3.94)	244 (9.61)	161 (6.34)	87 (3.43)	180 (7.09)	87.4 (3.44)	168 (6.61)	136 (5.35)
<b>22-JBCC (C)</b>	130 (5.12)	320 (12.60)	205 (8.07)	116 (4.57)	260 (10.24)	-	246 (9.69)	180 (7.1)

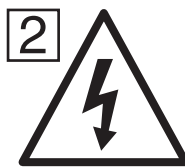
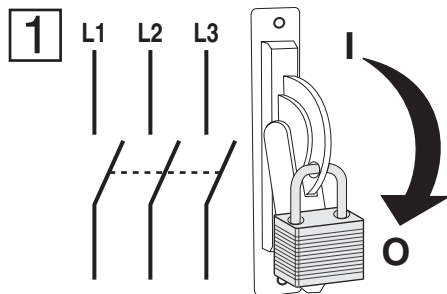

Wait three minutes for capacitors to discharge to safe voltage levels.

Drei Minuten warten, bis die Kondensatoren sich auf eine sichere Spannung entladen haben.

Attendre trois minutes pour s'assurer que les condensateurs se sont déchargés jusqu' à des niveaux de tension sans danger.

Attendere tre minuti affinché i condensatori si scarichino fino a raggiungere un livello di tensione sicuro.

Espre tres minutos a que los condensadores se descar-guen a niveles seguros de tensión; de lo contrario puede sufrir lesiones o incluso la muerte.

Wacht drie minuten zodat de condensators zich kunnen ontladen tot een veilig niveau.

Espre três minutos para que os capacitores descarreguem a níveis seguros de tensão.

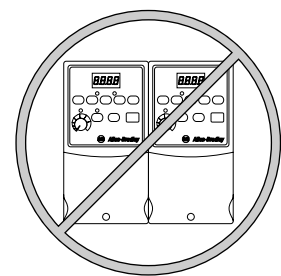
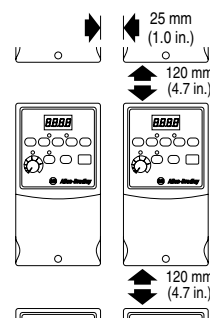
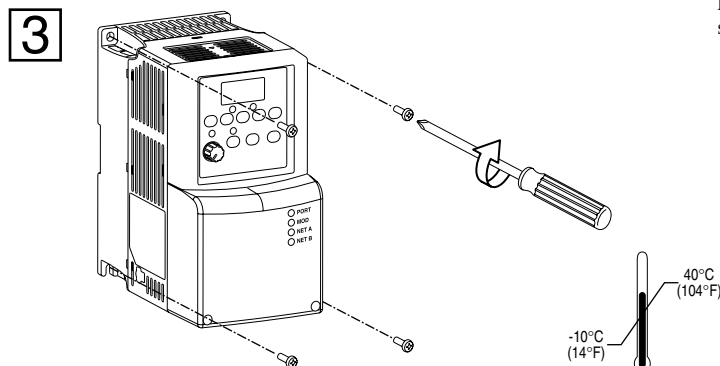

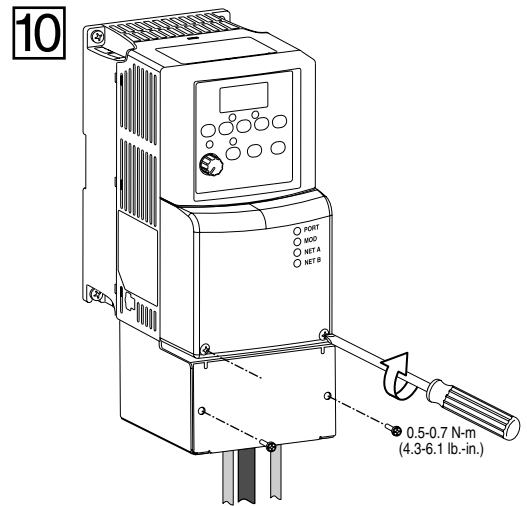
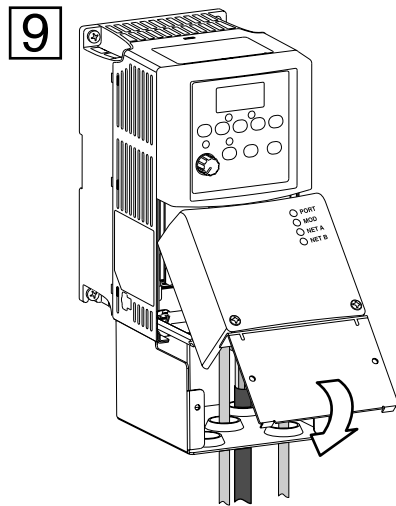
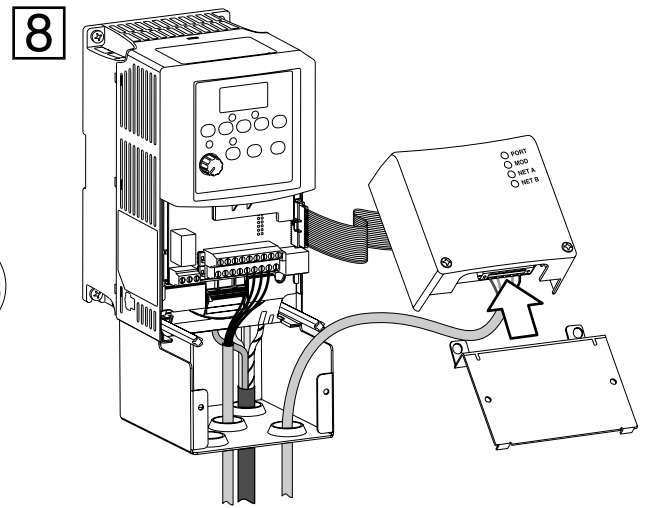
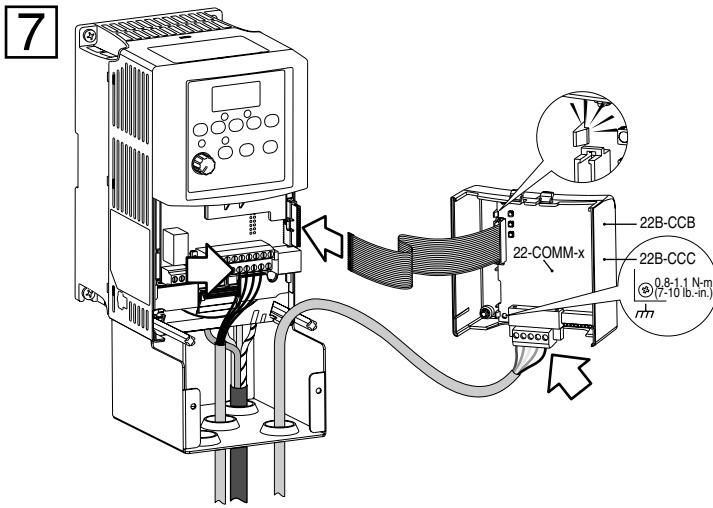
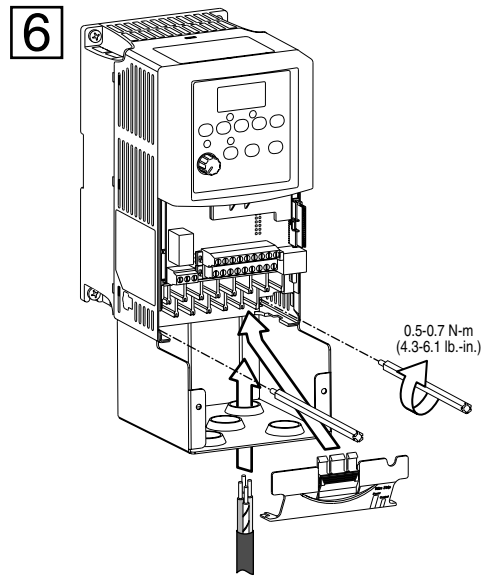
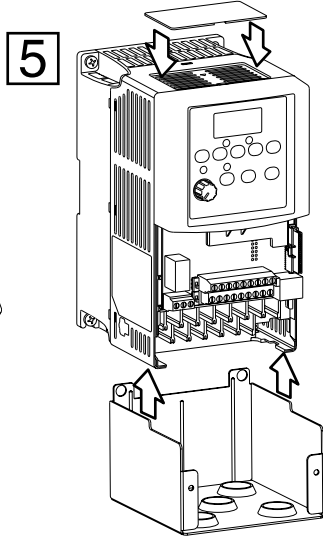
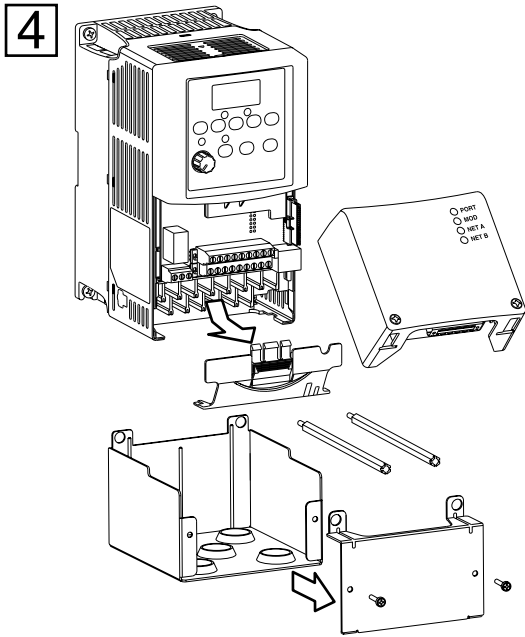

[www.abpowerflex.com](http://www.abpowerflex.com)

[www.rockwellautomation.com](http://www.rockwellautomation.com)

U.S. Allen-Bradley Drives Technical Support

Tel: (1) 262.512.8176, Fax: (1) 262.512.2222, Email: [support@drives.ra.rockwell.com](mailto:support@drives.ra.rockwell.com), Online: [www.ab.com/support/abdrives](http://www.ab.com/support/abdrives)

Publication 22B-IN003A-MU-P – May 2003



5011616200-40K0



Copyright © 2003 Rockwell Automation. All rights reserved. Printed in Taiwan.