



PROFIBUS DP Digital Base Terminal Block CompactBlock LDX I/O

(Cat. Nos. 1790P-T8BV8V, -T8BV8B, -T0W6)

What This Document Describes

This document describes how to install your PROFIBUS DP CompactBlock LDX I/O.

For information on:	Refer to page:
GSD File Requirements	below
Important User Information	2
Installing CompactBlock LDX I/O	5
Wiring the Terminal Blocks	9
Wiring the PROFIBUS Connector	10
Troubleshooting	12
Specifications	13

GSD File Requirements

Current functionality of PROFIBUS DP CompactBlock LDX I/O blocks requires GSD files.

These files are easy to install and are available online at:
www.ab.com/networks/gsd/

Important User Information

Because of the variety of uses for the products described in this publication, those responsible for the application and use of these products must satisfy themselves that all necessary steps have been taken to assure that each application and use meets all performance and safety requirements, including any applicable laws, regulations, codes and standards. In no event will Rockwell Automation be responsible or liable for indirect or consequential damage resulting from the use or application of these products.

Any illustrations, charts, sample programs, and layout examples shown in this publication are intended solely for purposes of example. Since there are many variables and requirements associated with any particular installation, Rockwell Automation does not assume responsibility or liability (to include intellectual property liability) for actual use based upon the examples shown in this publication.

Allen-Bradley publication SGI-1.1, *Safety Guidelines for the Application, Installation and Maintenance of Solid-State Control* (available from your local Rockwell Automation office), describes some important differences between solid-state equipment and electromechanical devices that should be taken into consideration when applying products such as those described in this publication.

Reproduction of the contents of this copyrighted publication, in whole or part, without written permission of Rockwell Automation, is prohibited.

Throughout this publication, notes may be used to make you aware of safety considerations. The following annotations and their accompanying statements help you to identify a potential hazard, avoid a potential hazard, and recognize the consequences of a potential hazard

WARNING

Identifies information about practices or circumstances that can cause an explosion in a hazardous environment, which may lead to personal injury or death, property damage, or economic loss.

ATTENTION

Identifies information about practices or circumstances that can lead to personal injury or death, property damage, or economic loss.

IMPORTANT

Identifies information that is critical for successful application and understanding of the product.

Preventing Electrostatic Discharge

This equipment is sensitive to electrostatic discharge, which can cause internal damage and affect normal operation. Follow these guidelines when you handle this equipment:

ATTENTION

- Touch a grounded object to discharge potential static.
 - Wear an approved grounding wriststrap.
 - Do not touch connectors or pins on component boards.
 - Do not touch circuit components inside the equipment.
 - If available, use a static-safe workstation.
 - When not in use, store the equipment in appropriate static-safe packaging.
-

Environment and Enclosure

This equipment is intended for use in a Pollution Degree 2 industrial environment, in overvoltage Category II applications (as defined in IEC publication 60664-1), at altitudes up to 2000 meters without derating.

This equipment is considered Group 1, Class A industrial equipment according to IEC/CISPR Publication 11. Without appropriate precautions, there may be potential difficulties ensuring electromagnetic compatibility in other environments due to conducted as well as radiated disturbance.

ATTENTION



This equipment is supplied as “open type” equipment. It must be mounted within an enclosure that is suitably designed for those specific environmental conditions that will be present and appropriately designed to prevent personal injury resulting from accessibility to live parts. The interior of the enclosure must be accessible only by the use of a tool. Subsequent sections of this publication may contain additional information regarding specific enclosure type ratings that are required to comply with certain product safety certifications.

NOTE: See NEMA Standards publication 250 and IEC publication 60529, as applicable, for explanations of the degrees of protection provided by different types of enclosure. Also, see the appropriate sections in this publication, as well as the Allen-Bradley publication 1770-4.1 (“Industrial Automation Wiring and Grounding Guidelines”), for additional installation requirements pertaining to this equipment.

Installing CompactBlock LDX I/O

Follow these steps to install the base block:

1. Set the station address on the base block.
2. Mount the base block.
3. Mount the optional expansion blocks.
4. Wire the terminal blocks.
5. Connect the PROFIBUS connector.
6. Connect power to the block.

These steps are explained in detail in the following procedures.

Set the Station Address on the Base Block

To set the station address, adjust the switches on the front of the base block. The two switches are most significant digit (MSD) and least significant digit (LSD). The switches can be set between 00 and 99.

The base block reads the rotary switches at power-up only.

Example: Station
Address is set at 11

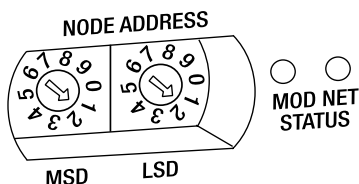

Mount the Base Block

You can mount the base block to a panel or DIN rail. We recommend that you ground the panel or DIN rail before mounting the base block.

WARNING



When used in a Class I, Division 2, hazardous location, this equipment must be mounted in a suitable enclosure with the proper wiring method that complies with the governing electrical codes.

Panel Mounting

1. Place the base block against the panel where you want to mount it.
2. Gently pull and position the expansion cover to the left.
3. Place a center punch, nail or similar device through the mounting holes in the base block and make two marks on the panel (lower left and upper right corners of the base block).
4. Remove the base block and drill two holes in the panel to accommodate each of the mounting screws.

- Replace the base block on the panel and place a screw through each of the two mounting holes. Tighten the screws until the base block is firmly in place.

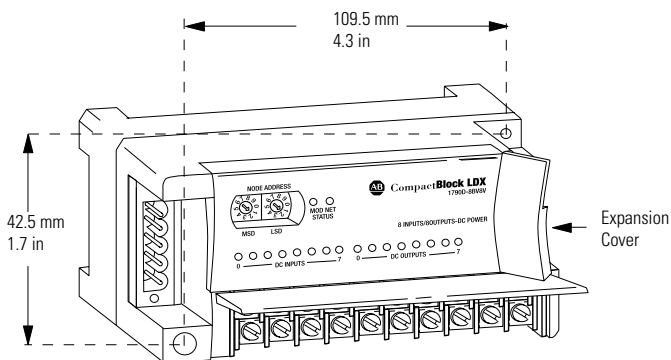

DIN Rail Mounting

- Hook the top slot of the base block over the DIN Rail.
- Pull down on the locking lever while pressing the base block against the rail.

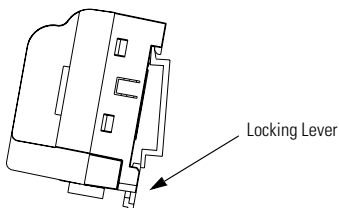

- When the base block is flush against the rail, push up on the locking lever to secure the base block to the rail.

Mount the Optional Expansion Blocks

IMPORTANT

The analog base blocks can accommodate a maximum of two discrete expansion blocks. The RTD and thermocouple base blocks do not support any expansion blocks.

Mount the expansion block by connecting it to a previously-installed CompactBlock LDX I/O base or expansion block.

Beginning with the base block, you can mount your expansion blocks either horizontally or vertically:

- horizontally (left to right) - add expansion blocks in an end-to-end configuration
- vertically (up or down) - add expansion blocks either up or down in a back-to-back configuration. In this configuration, you must use the optional 15cm ribbon cable (1790-15CMCBL) and alternately position the blocks in a right-side up, upside-down fashion.

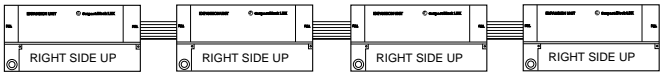

Horizontal mounting

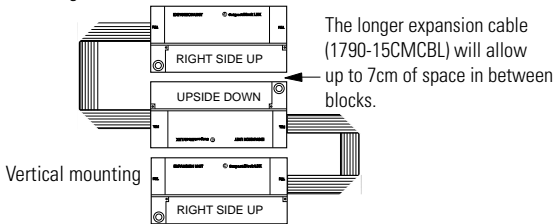

Vertical mounting

You can mount your blocks on a panel or DIN rail as described in the previous section.

Wire the Terminal Block

The following figures show the wiring information for the terminal blocks.

1790P-T8BV8V Input/Output Base Block Wiring Diagram

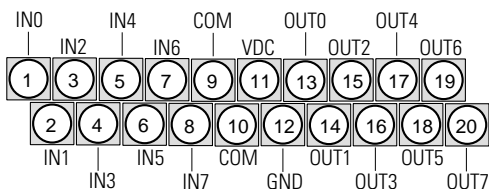

- **Sinking inputs** - wire COM (pin 9) to Field Power (-) GND
- **Sourcing inputs** - wire COM (pin 9) to Field Power (+) 24V dc
- **Note:** both COM (pins 9 and 10) are internally connected.
- **Sinking outputs** - wire VDC (pin 11) to Field Power (+) 24Vdc, wire GND (pin 12) to Field Power (-) GND

1790P-T8BV8B Input/Output Base Block Wiring Diagram

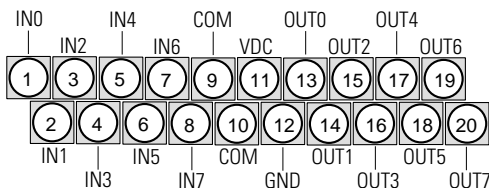

- **Sinking inputs** - wire COM (pin 9) to Field Power (-) GND
- **Sourcing inputs** - wire COM (pin 9) to Field Power (+) 24Vdc
- **Note:** both COM (pins 9 and 10) are internally connected.
- **Sourcing outputs** - wire VDC (pin 11) to Field Power (+) 24Vdc, wire GND (pin 12) to Field Power (-) GND

1790P-T0W6 Relay Output Base Block Wiring Diagram

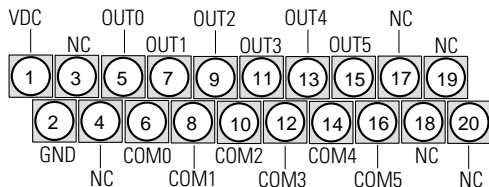

- Wire VDC (pin 1) to Field Power (+) 24Vdc
- Wire GND (pin 2) to Field Power (-) GND

Wire and Connect the PROFIBUS DP Terminal Connector

Follow these procedures when connecting the PROFIBUS DP terminal connector to the base block.

WARNING

If you connect or disconnect the PROFIBUS cable with power applied to this module or any device on the network, an electrical arc can occur. This could cause an explosion in hazardous location installations. Be sure that power is removed or the area is nonhazardous before proceeding.

The required PROFIBUS female 9-pin D-sub connector is not supplied with the base block; you must purchase it separately.

Before you connect the female 9-pin D-sub connector to the base block, make sure it is wired correctly, as shown in the following table.

Pin Number:	Name:	Description:
1	shield	Shield, Protective Ground
2	M24V	Minus 24V Output Voltage
3	RxD/TxD-P	Receive/Transmit-Data-P
4	CNTR-P	Control-p
5	DGND	Data Ground
6	VP	Voltage-Plus
7	P24V	Plus 24V Output Voltage
8	RxD/TxD-N	Receive/Transmit-Data-N
9	CNTR-N	Control-N

Once you have properly wired the connector, attach it to the base block as shown below. Use the locking screws on the connector to fasten it to the base block.

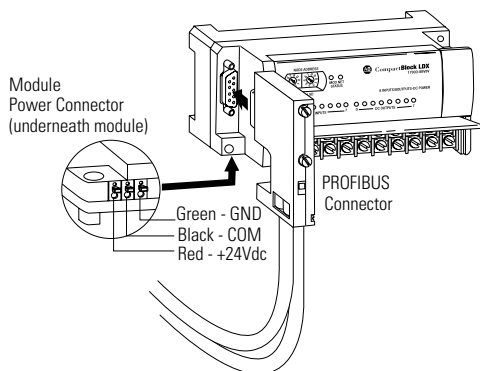

Connect Power to the Block

To apply power to the block, refer to the above illustration.

Troubleshoot with the Indicators

The base block has the following indicators:

- module status
- network status
- I/O status

Mod/Net Status Indicator		
LED Indicator:	Status:	Description:
Module Status	Solid Red	Unrecoverable fault in base block
	Flashing Red	Unrecoverable fault in expansion unit
	Solid Green	Normal operation - OK
	Off	No power
LED Indicator:	Status:	Description:
Network Status	Solid Red	Unrecoverable communication fault
	Flashing Red	Recoverable communication fault
	Solid Green	Communication path complete - OK
	Flashing Green	Communication path incomplete

I/O Status Indicators			
Function:	LED Color:	Module Illumination:	Condition:
Outputs	Each output: Green	None Green	Output not energized Output energized
Inputs	Each Input: Green	None Green	No valid input Valid input

PROFIBUS DP Digital Base Terminal Block Specifications

The following table contains specifications that are common to all of the base blocks in this document. Individual base block specifications are detailed after this table.

Environmental Specifications	
Operating Temperature	0 to 55°C (32 to 131°F) IEC 60068-2-1 (Test Ad, Operating Cold), IEC 60068-2-2 (Test Bd, Operating Dry Heat), IEC 60068-2-14 (Test Nb, Operating Thermal Shock)
Storage Temperature	-40 to 85°C (-40 to 185°F) IEC 60068-2-1 (Test Ab, Un-packaged Non-operating Cold), IEC 60068-2-2 (Test Bb, Un-packaged Non-operating Dry Heat), IEC 60068-2-14 (Test Na, Un-packaged Non-operating Thermal Shock)
Relative Humidity	5-90% non-condensing IEC 60068-2-30 (Test Db, Un-packaged Non-operating)
Operating Altitude	2000m
Vibration	I2g @ 10-500Hz EC60068-2-6 (Test Fc, Operating)
Shock: Operating Non-operating	10g 30g IEC60068-2-27 (Test Ea, Unpackaged Shock)
Emissions	Group 1, Class A CISPR 11
ESD Immunity	8kV air discharges IEC 61000-4-2
Radiated RF Immunity	10V/m with 1kHz sine-wave 80%AM from 80MHz to 1000MHz 10V/m with 200Hz 50% Pulse 100%AM @ 900Mhz IEC 61000-4-3
EFT/B Immunity	+1kV @ 5kHz on power ports +2kV @ 5kHz on signal ports +2kV @ 5kHz on communications ports IEC 61000-4-4
Surge Transient Immunity	+1kV line-line(DM) and ±2kV line-earth(CM) on power ports +1kV line-line(DM) and ±2kV line-earth(CM) on signal ports ±2kV line-earth(CM) on shielded ports IEC 61000-4-5
Conducted RF Immunity	10Vrms with 1kHz sine-wave 80%AM from 150kHz to 80MHz IEC 61000-4-6
Enclosure Type Rating	None (open style)
Mounting	DIN rail or screw
Dimensions	52x118.5x42mm (2.03x4.62x1.64in)
Weight	0.3lb (0.1kg)

PROFIBUS DP Specifications

Network Protocol	PROFIBUS-DP (EN50170) <ul style="list-style-type: none"> • Communication of the slave with a Class 1 master • Communication of the slave with a Class 2 master
Redundancy	Not supported
Repeater Control Signal	RS485 signal
Implementation Type	DPC31
Freeze Mode	Supported
Sync Mode	Supported
Auto Baud Rate	Supported
Fail Safe Mode	Supported ¹
Station Type	Slave
FMS Support	Not supported
Indicators	1 red/green module status 1 red/green network status
Number of nodes	100 maximum - rotary switch type node address setting (0-99)
Network Length/ Communication rate	9.6Kbps @ 1000m (3280ft) 19.2Kbps @ 1000m (3280ft) 45.45Kbps @ 1000m (3280ft) 93.75Kbps @ 1000m (3280ft) 187.5Kbps @ 1000m (3280ft) 500Kbps @ 400m (1312ft) 1.5mbps @ 200m (656ft) 3mbps @ 100m (328ft) 6mbps @ 100m (328ft) 12mbps @ 100m (328ft)
Isolation	Type test 1250Vac rms for 60 seconds between field power and PROFIBUS (I/O to logic)

General Specifications

Wiring Category	2 ²	
Product Certifications (when product is marked)	c-UL-us	UL Listed for Class I, Division 2 Group A,B,C,D Hazardous Locations, certified for U.S. and Canada
	CE ³	European Union 89/336/EEC EMC Directive, compliant with: EN 61000-6-4; Industrial Emissions EN 50082-2; Industrial Immunity EN61326; Meas./Control/Lab., Industrial Requirements EN 61000-6-2; Industrial Immunity European Union 73/23/EEC LVD Directive, compliant with: EN 61131-2; Programmable Controllers
	C-Tick ³	Australian Radiocommunications Act, compliant with: AS/NZS CISPR11; Industrial Emissions

¹ Dependent upon the scanner module being used. For example, the SST Scanner (cat. no. SST-PFB-SLC) does not fully support Fail Safe mode as it only resets outputs to 0. You cannot define behavior such as Hold Last State or Fault Value with the SST Scanner.

² Refer to publication 1770-4.1, *Programmable Controller Wiring and Grounding Guidelines*.

³ See the Product Certification link at www.ab.com for Declarations of Conformity, Certificates and other certification details.

DC Input/Output Combination Base Block Specifications

1790P-T8BV8V, -T8BV8B	
INPUT SPECIFICATIONS	
Inputs per base block	8 points non-isolated, sinking or sourcing
On-state voltage	9.6V dc minimum 24V dc nominal 28.8V dc maximum
On-state current	8mA maximum per point @ 28.8V dc
Off-state voltage	5V dc maximum
Nominal input impedance	4.8K Ω
Input Signal Delay	Off to On: 10ms maximum On to Off: 10ms maximum
Indicators	8 green status
Common type	8 points/2 COM (non-polarity) - 1790P-T8BV8V 8 points/2 COM (non-polarity) - 1790P-T8BV8B
OUTPUT SPECIFICATIONS	
Outputs per base block	8 points non-isolated, sinking - 1790P-T8BV8V 8 points non-isolated, sourcing - 1790P-T8BV8B
On-state voltage	10V dc minimum 24V dc nominal 28.8V dc maximum
On-state voltage drop	0.5V dc maximum
On-state current	1mA minimum per channel
Off-state leakage	0.5mA maximum
Output signal delay	Off to On: 0.5ms maximum On to Off: 1.0ms maximum
Indicators	8 green status
Output current rating	Maximum 0.5A per output 4.0A maximum per common
Common type	8 points/2 COM - 1790P-T8BV8V 8 points/2 COM - 1790P-T8BV8B

General Specifications

PROFIBUS Power	Supply voltage - 24V dc nominal Voltage range - 19.2-28.8V dc Power dissipation - 1.2W maximum @ 28.8V dc
Field Power	Supply voltage - 24V dc nominal Voltage range - 10-28.8V dc Power dissipation - 3.22W @ 28.8V dc
Isolation	I/O to logic: photocoupler isolation Isolation voltage: 1250V ac rms PROFIBUS to logic: non-isolated PROFIBUS power: non-isolated
Wiring	Terminal block (M3.0) - screw torque: 7 inch-pounds maximum (use copper or copper-clad aluminum conductors)



AC/DC Relay Output Base Block Specifications

1790P-TOW6

Relay type	Form A, normally open Single pole, single throw
Output voltage range (load dependent)	5-28V dc @ 2.0A resistive 48V dc @ 0.8A resistive 125V ac @ 2.0A resistive 250V ac @ 2.0A resistive
Minimum load	100 μ A, 100mV dc per point
Maximum on-state voltage drop	0.5V @ 2.0A, resistive load, 24V dc
Initial Contact Resistance	30m ohm
Expected contact life	300K cycles resistive 100K cycles inductive
Maximum off-state leakage	1.5mA maximum
Output delay time	10ms maximum on to off 10ms maximum off to on
Indicators	6 green status
Common type	1 point/1COM

General Specifications	
PROFIBUS Power	Supply voltage - 24V dc nominal Voltage range - 19.2-28.8V dc Power dissipation - 1.2W maximum @ 28.8V dc
Field Power	Supply voltage - 24V dc nominal Voltage range - 19.2-28.8V dc Power dissipation - 1.7W @ 28.8V dc
Isolation	I/O to logic: photocoupler isolation Isolation voltage: 1250V ac rms
Wiring	Terminal block (M3.0) - screw torque: 7 inch-pounds maximum (use copper or copper-clad aluminum conductors)

Important: Input and output wiring must be in accordance with Class 1, Division 2 wiring methods and in accordance with the authority having jurisdiction.

<p>The following information applies when operating this equipment in hazardous locations:</p>	<p>Informations sur l'utilisation de cet équipement en environnements dangereux :</p>		
<p>Products marked "CL I, DIV 2, GP A, B, C, D" are suitable for use in Class I Division 2 Groups A, B, C, D, Hazardous Locations and nonhazardous locations only. Each product is supplied with markings on the rating nameplate indicating the hazardous location temperature code. When combining products within a system, the most adverse temperature code (lowest "T" number) may be used to help determine the overall temperature code of the system. Combinations of equipment in your system are subject to investigation by the local Authority Having Jurisdiction at the time of installation.</p>	<p>Les produits marqués "CL I, DIV 2, GP A, B, C, D" ne conviennent qu'à une utilisation en environnements de Classe I Division 2 Groupes A, B, C, D dangereux et non dangereux. Chaque produit est livré avec des marquages sur sa plaque d'identification qui indiquent le code de température pour les environnements dangereux. Lorsque plusieurs produits sont combinés dans un système, le code de température le plus défavorable (code de température le plus faible) peut être utilisé pour déterminer le code de température global du système. Les combinaisons d'équipements dans le système sont sujettes à inspection par les autorités locales qualifiées au moment de l'installation.</p>		
<p>WARNING</p> 	<p>EXPLOSION HAZARD</p> <ul style="list-style-type: none"> • Do not disconnect equipment unless power has been removed or the area is known to be nonhazardous. • Do not disconnect connections to this equipment unless power has been removed or the area is known to be nonhazardous. Secure any external connections that mate to this equipment by using screws, sliding latches, threaded connectors, or other means provided with this product. • Substitution of components may impair suitability for Class I, Division 2. • If this product contains batteries, they must only be changed in an area known to be nonhazardous. 	<p>AVERTISSEMENT</p> 	<p>RISQUE D'EXPLOSION</p> <ul style="list-style-type: none"> • Couper le courant ou s'assurer que l'environnement est classé non dangereux avant de débrancher l'équipement. • Couper le courant ou s'assurer que l'environnement est classé non dangereux avant de débrancher les connecteurs. Fixer tous les connecteurs externes reliés à cet équipement à l'aide de vis, loquets coulissants, connecteurs filetés ou autres moyens fournis avec ce produit. • La substitution de composants peut rendre cet équipement inadapté à une utilisation en environnement de Classe I, Division 2. • S'assurer que l'environnement est classé non dangereux avant de changer les piles.

Allen-Bradley and Compact**Block LDX** are trademarks of Rockwell Automation.
 PROFIBUS DP is a trademark of PROFIBUS Trade Organization.

www.rockwellautomation.com

Power, Control and Information Solutions Headquarters

Americas: Rockwell Automation, 1201 South Second Street, Milwaukee, WI 53204-2496 USA, Tel: (1) 414.382.2000, Fax: (1) 414.382.4444

Europe/Middle East/Africa: Rockwell Automation, Vorstlaan/Boulevard du Souverain 36, 1170 Brussels, Belgium, Tel: (32) 2 663 0600, Fax: (32) 2 663 0640

Asia Pacific: Rockwell Automation, Level 14, Core F, Cyberport 3, 100 Cyberport Road, Hong Kong, Tel: (852) 2887 4788, Fax: (852) 2508 1846

Publication 1790-IN009B-EN-P - April 2003

PN957782-06

Supersedes Publication 1790-IN009A-EN-P - February 2002

© 2003 Rockwell Automation. Printed in USA